

# MeasureReady™ 155 Precision I/V Source



*An ultra-low noise, high-precision current/voltage source for scientific and other demanding applications*

# Built for Science. Designed for People.



*DC-low noise  
performance without  
compromising  
AC bandwidth*

## MeasureReady™ 155 Source features

- Bipolar, 4-quadrant I/V source
- DC and AC modes, up to 100 kHz\*
- Full scale ranges—voltage: 10 mV to 100 V, current: 1  $\mu$ A to 100 mA
- 0.001% programming resolution (from 100 nV/10 pA)
- In-phase reference output for use with a lock-in amplifier (155-AC only)
- Ultra-low noise: from 200 nV/7 pA RMS
- Manual and autorange function
- Front and rear output connectors
- Touchscreen user interface

\*MeasureReady 155-AC

The MeasureReady™ 155 Precision I/V source combines premium performance with unprecedented simplicity for materials scientists and engineers requiring a precise source of current and voltage.

With extensive experience in low-noise instrumentation for research, Lake Shore has leveraged the latest electronic technologies to reduce in-band and out-of-band noise floors for the MeasureReady 155 source to levels previously only possible using add-on filters. The result is a combination AC/DC current and voltage source that is well-suited to the challenges of characterizing sensitive materials and devices, where lower excitation signals are needed and minimum injection of noise into the measurement is required.

While sophisticated on the inside, the 155 is uncommonly straightforward to operate. Leading product designers observe that simple is much harder to accomplish than complex — just putting a touchscreen on a complex product doesn't make it simpler. Lake Shore's modern, user-focused design for the MeasureReady 155 presents an uncluttered and intuitive interface that instantly feels familiar and natural to anybody who owns a smartphone.

## Full connectivity

USB and LAN connectivity provide convenient integration with systems using LabVIEW™, IVI.NET, and other software. Interfacing is straightforward using IVI-class drivers and industry-standard SCPI commands.

## From precision thermometry to advanced measurement

For decades, Lake Shore has advanced science by providing cryogenic temperature and magnetic instrumentation to researchers and engineers. At the heart of these instruments are special low-noise current and voltage sources that excite the attached sensors. This has led us to develop ultra-low noise voltage and current sources as standalone instruments for a wider range of demanding applications. The all-new design of the 155 source offers premium performance, easy operation, and modern convenience, backed by Lake Shore's quality and service.

See and operate more easily with TiltView™

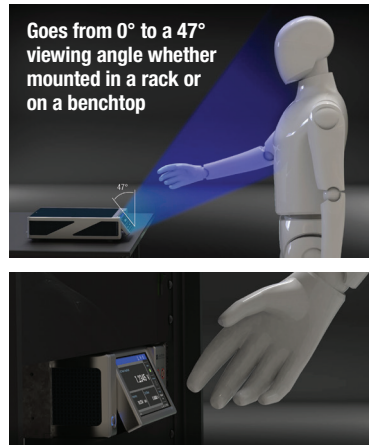

### Maximum angle of operation comparison

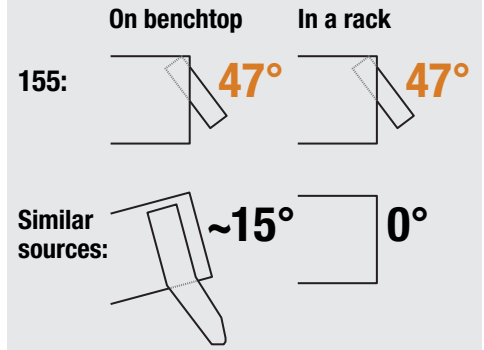

This unique feature makes seeing the screen and operating the touch interface comfortable from any angle, even when mounted in a rack.

### For applications where noise matters

The MeasureReady 155 is designed for demanding scientific and engineering applications, where a high-quality, low-noise source of current or voltage is required, such as:

- Precision DC I-V and C-V curve measurements of novel materials and early-stage devices
- AC impedance measurements
- Accurate resistance, magneto-resistance, and resistivity measurements
- Low-noise bias voltages/currents for characterizing new heterostructures
- High-accuracy device testing
- Very low power excitation of sensitive materials like organics
- Controlled characterization of low resistance and superconducting materials
- Low-noise excitation of sensors for improved measurement accuracy
- Hall effect measurements to determine carrier concentrations/mobilities
- Variable temperature device/material characterization using a cryogenic probe station
- Sensitive electrochemical experiments

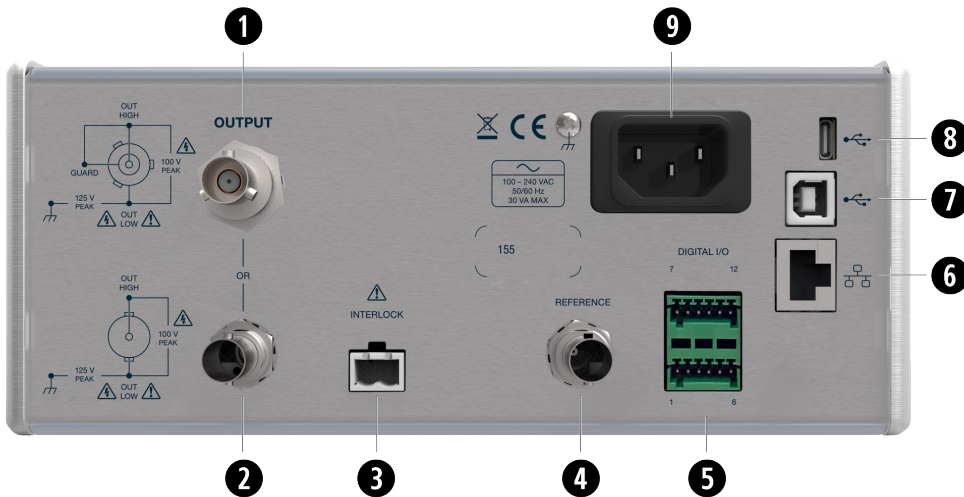

MeasureReady™ 155 rear panel

- |   |                              |                                |
|---|------------------------------|--------------------------------|
| 1 Triaxial output connector                 | 4 Reference output connector | 7 USB communications interface |
| 2 BNC output connector                      | 5 TTL digital IO port        | 8 USB thumb drive interface    |
| 3 Safety interlock terminal block connector | 6 RJ-45 Ethernet interface   | 9 Line input assembly          |

## Lower noise for better measurements

### No filters needed

Characterization of sensitive new electronic materials often requires both AC and DC excitation signals, with source noise directly impacting measurement sensitivity.

To ensure high performance and functionality in an AC source, typically DC noise performance is compromised (and vice versa) because the filtering most often used to quiet DC noise also dampens AC signals and affects stepping and pulse width modulation. The 155 was purposefully engineered to achieve low-noise levels without additional filtering, enabling exceptional output performance in both DC and AC modes.

In side-by-side tests, the 155 demonstrated a cleaner output signal with a lower noise floor than other commercial sources costing far more. That's a key reason why the 155 provides a solid foundation for researchers performing I/V curve, Hall effect, resistance, resistivity, and other fundamental measurements of novel materials and early-stage devices.

### Uncompromised noise performance

The 155 generates just 200 nV RMS (1  $\mu$ V p-p) of low frequency (<10 Hz) noise and 9  $\mu$ V RMS of higher frequency (10 Hz to 100 kHz) noise in the 10 mV range. With a programming resolution of 100 nV, the 155 is ideal when a very clean, ultra-low voltage output is required. For low current signals, the 155 is equally capable — just 7 pA RMS of low frequency noise and a very low 1 nA RMS of higher frequency noise in the 1  $\mu$ A range, with a 10 pA setting resolution.

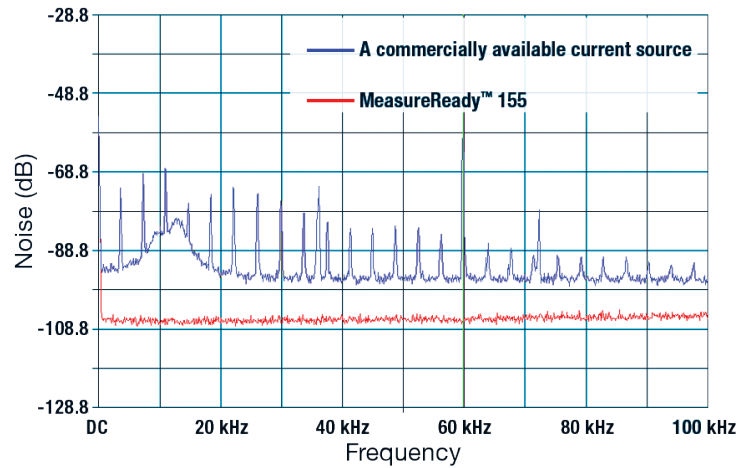

Comparison of the MeasureReady 155 (red) to another commercial current source (blue) at 100 mA into a 100  $\Omega$  resistor. The noise (in dB) is shown as a function of frequency from DC to 100 kHz. The noise spectrum of the blue trace clearly shows harmonics occurring at ~5 kHz intervals. Adding this type of noise to a measurement will require a larger number of data points to be averaged.

## As easy to use as your smartphone

Made for the way you work today, the MeasureReady 155 source features an uncluttered touch display with a unique TiltView™ screen, presenting a natural and engaging user interface.

With no confusing buttons or long learning curves, the 155 is simple and intuitive to operate. You'll quickly recognize the icons, gestures, and menu styles that follow familiar smartphone technology standards.

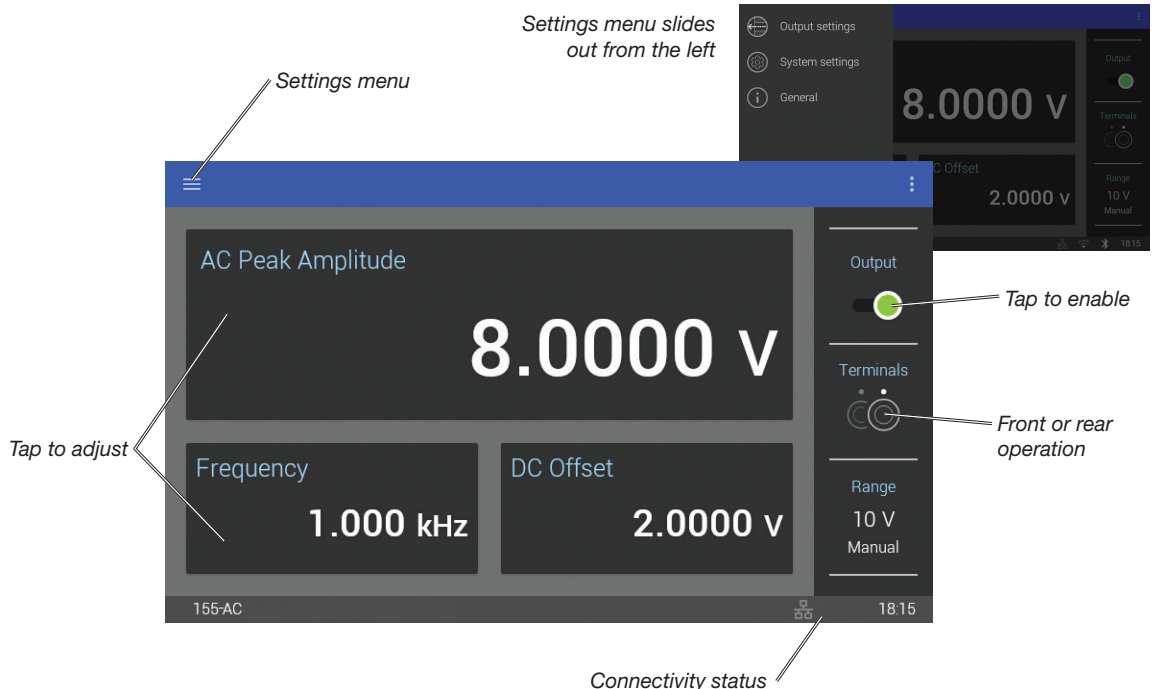

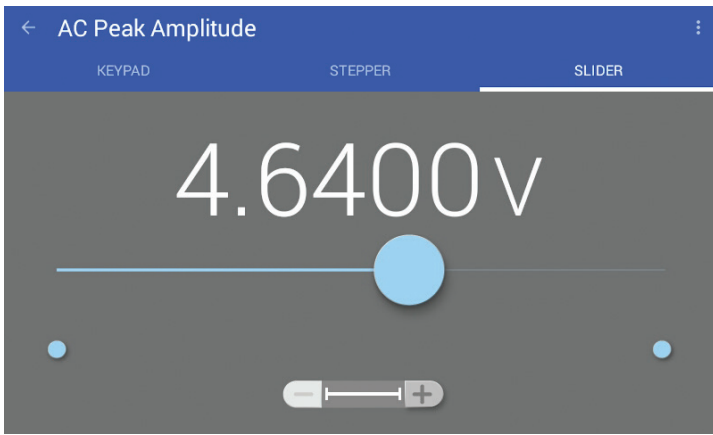

The MeasureReady 155 offers multiple ways to adjust settings, including a “slider” control for fast adjustments. You can use the zoom control (below main slider) for more precise control.

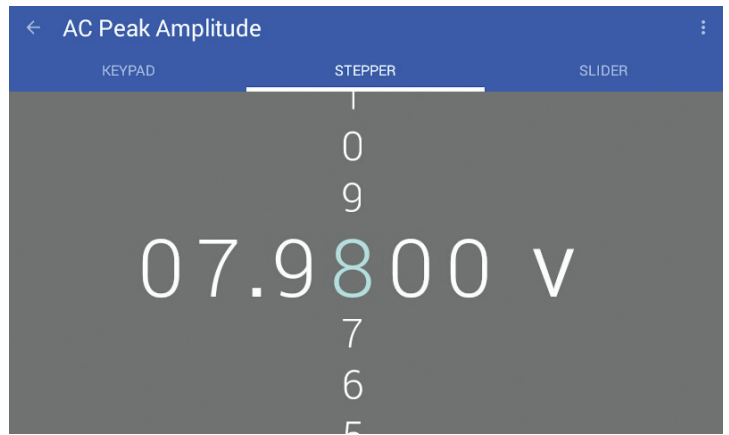

Swiping up or down on the screen allows single digit adjustments using the “stepper” control for slower, incremental changes.

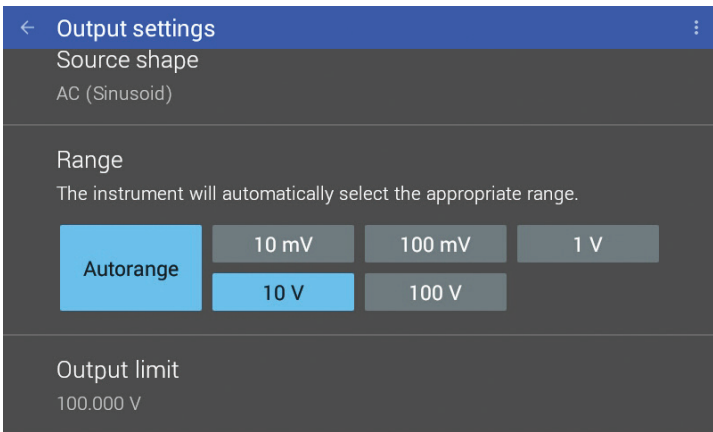

Changing settings is simple and intuitive.

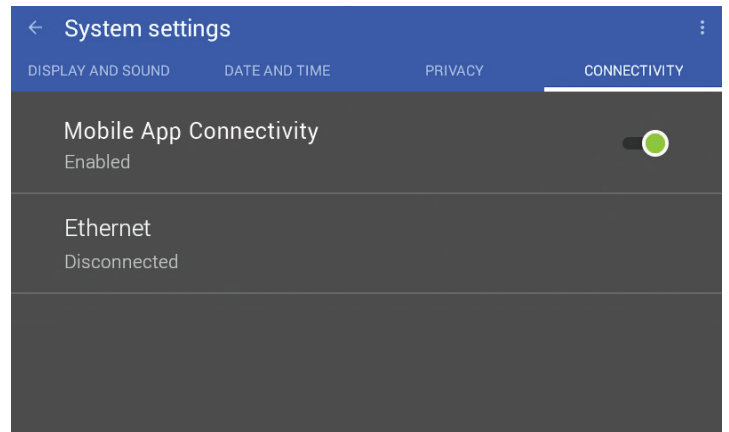

155 connectivity.

### Portrait orientation



Need more space on your lab bench? Turn the 155 vertically and the display adjusts automatically.

## Options

### MR-GPIB-USB

GPIB to USB adapter for XIP instruments

This GPIB communication adapter can be used with any MeasureReady® instrument via the USB Type-C™ connector. It is configurable through screen input and includes an LED status indicator.



## Be future-ready with MeasureReady

With free online software updates, your instrument can always have the most current capabilities. And as Lake Shore introduces new options in the future, you can purchase and download them to your instrument. This allows the 155 to grow as your measurement needs evolve.

## Specifications

### Voltage source specifications

DC/peak ranges	Maximum peak current	Maximum peak power	Programming resolution (0.001%)	DC accuracy (1 year) calibration temperature °C ± 5 °C + (% setting + offset) <sup>1,7</sup>	AC accuracy (1 year) calibration temperature °C ± 5 °C + (% setting + % range) <sup>1,2,3</sup>	Temperature coefficient/°C 10 °C to 35 °C ± (% setting + offset)	Typical noise (pk-pk/RMS) 0.1 Hz to 10 Hz <sup>5</sup>	Typical noise (pk-pk/RMS) 10 Hz to 100 kHz <sup>5</sup>
10 mV	100 mA	1 mW	100 nV	0.2% + 140 µV	0.5 % + 0.2% (up to 20 kHz)	0.014% + 2 µV	1 µV/200 nV	45 µV/9 µV
100 mV		10 mW	1 µV	0.055% + 140 µV		0.0014% + 2 µV	1 µV/200 nV	45 µV/9 µV
1 V		100 mW	10 µV	0.045% + 170 µV		0.0007% + 3 µV	1.5 µV/300 nV	45 µV/9 µV
10 V		1 W	100 µV	0.045% + 500 µV		0.0007% + 30 µV	10 µV/2 µV	75 µV/15 µV
100 V	10 mA	1 W	1 mV	0.055% + 6 mV		0.0009% + 300 µV	100 µV/20 µV	750 µV/150 µV

### Current source specifications — low voltage compliance

DC/peak ranges	Peak compliance voltage	Maximum peak power	Programming resolution (0.001%)	DC accuracy (1 year) calibration temperature °C ± 5 °C + (% setting + offset) <sup>1</sup>	AC accuracy (1 year) calibration temperature °C ± 5 °C + (% setting + % range) <sup>1,2</sup>	Temperature coefficient/°C 10 °C to 35 °C ± (% setting + offset)	Typical noise (pk-pk/RMS) 0.1 Hz to 10 Hz <sup>5</sup>	Typical noise (pk-pk/RMS) 10 Hz to 100 kHz <sup>5</sup>
1 µA	10 V	10 µW	10 pA	0.05% + 500 pA	1% + 0.2% (up to 20 kHz)	0.0008% + 4 pA	40 pA/8 pA	10 nA/2 nA
10 µA		100 µW	100 pA	0.05% + 1.5 nA		0.0008% + 40 pA	40 pA/8 pA	10 nA/2 nA
100 µA		1 mW	1 nA	0.05% + 15 nA		0.0008% + 400 pA	200 pA/40 pA	10 nA/2 nA
1 mA		10 mW	10 nA	0.05% + 150 nA		0.0008% + 4 nA	2 nA/400 pA	20 nA/4 nA
10 mA		100 mW	100 nA	0.055% + 2.5 µA		0.0008% + 40 nA	20 nA/4 nA	200 nA/40 nA
100 mA		1 W	1 µA	0.1% + 70 µA		0.0008% + 400 nA	200 nA/40 nA	2 µA/400 nA

### Current source specifications — high voltage compliance

DC/peak ranges	Peak compliance voltage	Maximum peak power	Programming resolution (0.001%)	DC accuracy (1 year) calibration temperature °C ± 5 °C + (% setting + offset) <sup>1</sup>	AC accuracy (1 year) calibration temperature °C ± 5 °C + (% setting + % range) <sup>1,2</sup>	Temperature coefficient/°C 10 °C to 35 °C ± (% setting + offset)	Typical noise (pk-pk/RMS) 0.1 Hz to 10 Hz <sup>5</sup>	Typical noise (pk-pk/RMS) 10 Hz to 100 kHz <sup>5</sup>
1 µA	100 V	100 µW	10 pA	0.08% + 500 pA	1% + 0.2% (up to 20 kHz)	0.0025% + 4 pA	35 pA/7 pA	5 nA/1 nA
10 µA		1 mW	100 pA	0.08% + 1.5 nA		0.0025% + 40 pA	35 pA/7 pA	5 nA/1 nA
100 µA		10 mW	1 nA	0.08% + 15 nA		0.0025% + 400 pA	250 pA/50 pA	5 nA/1 nA
1 mA		100 mW	10 nA	0.08% + 150 nA		0.0025% + 4 nA	2.5 nA/500 pA	40 nA/8 nA
10 mA		1 W	100 nA	0.08% + 1.5 µA		0.0025% + 40 nA	25 nA/5 nA	400 nA/80 nA

<sup>1</sup> Calibration temperature is the ambient temperature during factor calibration, typically, 23 °C; reported by the instrument

<sup>2</sup> Specification guaranteed on the rear panel only

<sup>3</sup> Guaranteed into load no greater than 100 pF

<sup>4</sup> Loads for current settle time: 100 mA range: 100 Ω, 1 mA and 100 µA ranges: 10 kΩ, 10 µA, and 1 µA ranges: short

<sup>5</sup> Representative values

<sup>6</sup> Measured into 10 Ω resistor for 100 mA and 10 mA ranges with compliance voltage <10 V; measured into transimpedance amplifier with 1 kΩ feedback resistor for other cases

<sup>7</sup> Calibrated into >10 GΩ load

## Additional specifications

<b>Output selection modes</b>	Voltage or current
<b>Range selection modes</b>	Manual, autorange
<b>Current source compliance selection</b>	10 V or 100 V
<b>Programmable limits (DC only)</b>	I out: compliance voltage, V out: current limit
Accuracy	Positive output: +10%/-0% of setting (when setting is $\geq 10\%$ of its full-scale range) Negative output: -10%/+0% of setting (when setting is $\geq 10\%$ of its full-scale range)
Programming resolution	Current limit: 0.1% of full-scale current range (auto selected) Voltage limit: 10 mV (10 V compliance), 100 mV (100 V compliance)
<b>Polarity</b>	Bipolar, 4-quadrant
<b>Load impedance</b>	Capable of driving any resistive load within the I and V limitations of the source; stability maintained with reactive loads up to 50 $\mu$ F or 1 mH (with 100 $\Omega$ damping)
<b>AC frequency range</b>	100 mHz to 100 kHz
<b>AC frequency accuracy</b>	$\pm 0.06\%$
<b>AC signal types</b>	Sine
<b>Total harmonic distortion</b>	<0.1% from DC to 20 kHz, <1% from 20 kHz to 100 kHz
<b>Sample rate</b>	600 kilosamples per second
<b>Noise (10 Hz to 40 MHz)<sup>2,5</sup></b>	Voltage: $\leq 700$ $\mu$ V RMS, across all ranges Current: $\leq 8$ $\mu$ A RMS (400 $\mu$ V RMS across 50 $\Omega$ ), across all ranges
<b>Load regulation<sup>2</sup></b>	Voltage: 10 V range and below: <0.2% of range, 100 V range: <0.01% of range; Current: 10 V compliance: <0.01% of range, 100 V compliance: <0.01% of range
<b>Settling times</b>	Voltage: time to reach final value at open load condition: 25 $\mu$ s Current: time to reach final value into a given load <sup>4</sup> : 25 $\mu$ s
<b>Output lead connections</b>	Output HI, Output LO, Guard, Chassis Ground
<b>Connector type</b>	Front: safety banana jack Rear: BNC or triaxial (user selectable between front and rear panel)
<b>Guard output</b>	Maximum load current: 1 mA peak
<b>Power up protection</b>	Output terminals floating on power up
<b>Additional output features</b>	User-specified output setting limit, enable/disable output setting
<b>Warm-up time</b>	30 min (to achieve specified accuracy)
<b>Isolation</b>	Source output isolated from chassis ground
<b>Output capacitance</b>	Front: <100 pF, rear: <50 pF

### Reference output

<b>Signal type</b>	Synchronous with the source output signal, referenced to chassis ground
<b>Amplitude</b>	0 to +3.3 V nominal
<b>Accuracy<sup>5</sup></b>	Voltage: $\pm 3^\circ$ , up to 10 kHz Current <sup>6</sup> ( $\geq 100$ $\mu$ A range): $\pm 4^\circ$ , up to 10 kHz
<b>Phase compensation</b>	180.0° to +180.0° with 1° resolution
<b>Connector</b>	BNC
<b>Waveform</b>	Square wave

LabVIEW™ is a trademark of National Instruments. Neither Lake Shore Cryotronics, nor any software programs or other goods or services offered by Lake Shore, are affiliated with, endorsed by, or sponsored by National Instruments.

### Front panel

**Display** 5 in capacitive touch, color TFT-LCD WVGA (800 × 480) with LED backlight

### Interface

#### USB host

Type	USB 3.0, mass storage class (MSC) device
Function	Firmware updates, flash drive support
Location	Rear panel
Connector	USB Type-C™

#### USB device

Type	USB 2.0
Function	Emulates a standard RS-232 serial port
Protocol	Standard commands for programmable instruments (SCPI)
Baud rate	115,200
Connector	USB Type-B
Software support	LabVIEW™ and IVI.NET drivers (see <a href="http://www.lakeshore.com">www.lakeshore.com</a> )

#### Ethernet

Function	TCP/IP command and control, mobile app
App. layer protocol	Standard commands for programmable instruments (SCPI)
Connector	RJ-45
Speed	1 Gb/s
Software support	LabVIEW™ and IVI.NET drivers (see <a href="http://www.lakeshore.com">www.lakeshore.com</a> )

### Digital IO

<b>Connector</b>	6-pin 3.5 mm detachable terminal block
<b>Output</b>	2 TTL compatible output (3.3 V <sub>high</sub> nominal at 1 mA)
<b>Input</b>	2 TTL compatible input; V <sub>high</sub> nominal: 3.3 V; V <sub>low</sub> nominal: 0 V
<b>Grounding</b>	Referenced to chassis ground

### General

<b>Safety interlock</b>	2-pin 5.0 mm detachable terminal block, maximum 10 $\Omega$ external circuit impedance
<b>Ambient temperature</b>	10 °C to 35 °C at rated accuracy; 5 °C to 40 °C at reduced accuracy
<b>Power requirement</b>	100 V to 240 V (universal input), 50 to 60 Hz, 30 VA
<b>Size</b>	217 mm W × 87 mm H × 369 mm D (8.5 in × 3.4 in × 14.5 in), half rack
<b>Weight</b>	3.2 kg (7 lb)
<b>Approval</b>	CE mark

## Ordering Info

### MeasureReady™ 155 Sources

- 155-AC Precision I/V source for AC and DC operation—includes calibration certificate and 155-ACC-KIT
- 155-DC Precision I/V source for DC operation only—includes calibration certificate and 155-ACC-KIT

### Options

- MR-GPIB-USB GPIB to USB adapter for XIP instruments

### Accessories

- RM-1/2 Kit for mounting a single half-rack instruments in a 483 mm (19 in) rack
- RM-2 Kit for mounting two adjacent half-rack instruments in a 483 mm (19 in) rack
- G-106-735 2-pin voltage interlock connector with shorting connection (allows operation over 10 V)
- G-106-741 6-pin green Phoenix terminal block
- 119-155 MeasureReady 155 user manual
- CAL-155-CERT MeasureReady 155 recalibration with certificate
- CAL-155-DATA MeasureReady 155 recalibration with certificate and data

RMX-FULL

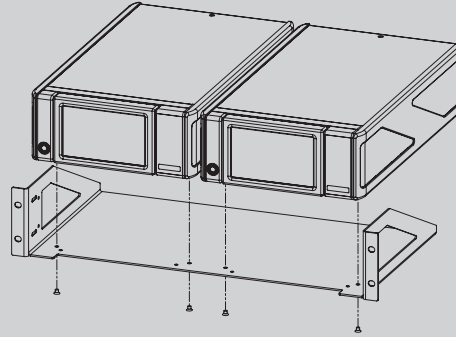

RMX-HALF

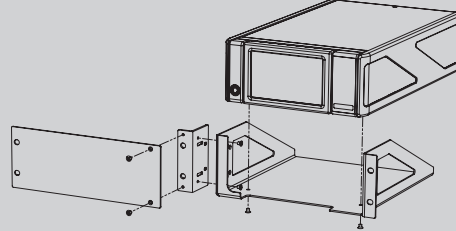

## About Lake Shore Cryotronics, Inc.

Supporting advanced research since 1968, Lake Shore is a leading innovator in measurement and control solutions for materials characterization under extreme temperature and magnetic field conditions. High-performance product solutions from Lake Shore include cryogenic temperature sensors and instrumentation, magnetic test and measurement systems, probe stations, and precision materials characterizations systems that explore the electronic and magnetic properties of next-generation materials. Lake Shore serves an international base of research customers at leading university, government, aerospace, and commercial research institutions and is supported by a global network of sales and service facilities.

Lake Shore Cryotronics, Inc.  
575 McCorkle Boulevard  
Westerville, OH 43082 USA  
Tel 614-891-2244  
Fax 614-818-1600  
e-mail [info@lakeshore.com](mailto:info@lakeshore.com)  
[www.lakeshore.com](http://www.lakeshore.com)

©2023 Lake Shore Cryotronics, Inc. All rights reserved.

The technical information contained herein is subject to change at any time. 112923