

User's Manual

Teslameter

F71 Multi-axis teslameter
F41 Single-axis teslameter

Software Version 2.0.2

Lake Shore Cryotronics, Inc.
575 McCorkle Blvd.
Westerville, Ohio
43082-8888 USA

sales@lakeshore.com
support@lakeshore.com

www.lakeshore.com

Fax: (614) 891-1392
Telephone: (614) 891-2243



Methods and apparatus disclosed and described herein have been developed solely on company funds of Lake Shore Cryotronics, Inc. No government or other contractual support or relationship whatsoever has existed which in any way affects or mitigates proprietary rights of Lake Shore Cryotronics, Inc. in these developments. Methods and apparatus disclosed herein may be subject to U.S. Patents existing or applied for.

Lake Shore Cryotronics, Inc. reserves the right to add, improve, modify, or withdraw functions, design modifications, or products at any time without notice. Lake Shore shall not be liable for errors contained herein or for incidental or consequential damages in connection with furnishing, performance, or use of this material.

Rev. 2.0

16 March 2026

LAKE SHORE LIMITED WARRANTY

WARRANTY PERIOD: THREE (3) YEARS for all products except system products. System products are TWO (2) YEARS. System products include but are not limited to; modular characterization systems, vibrating sample magnetometer systems, cryogenic probe stations, Hall effect systems, electromagnets, electromagnet power supplies, superconducting magnet systems, superconducting magnet power supplies, liquid nitrogen cooled cryostats, liquid helium-cooled cryostats, cryogen-free cryostats, and associated options and accessories.

Manufacturer Limited Warranty. The following is the limited warranty that Manufacturer offers on its Products. Distributor agrees that it shall not extend, expand or otherwise modify this limited warranty in any manner.

1. Lake Shore Cryotronics, Inc. ("Lake Shore") warrants that products manufactured by Lake Shore (the "Product") will be free from defects in materials and workmanship for the "Warranty Period" which starts on the date of shipment of the Product.
2. If Lake Shore receives notice of any such defects during the Warranty Period and the defective Product is shipped freight prepaid back to Lake Shore, Lake Shore will, at its option, either repair or replace the Product (if it is so defective) without charge for parts, service labor or associated customary return shipping cost to the Purchaser. Replacement for the Product may be by either new or equivalent in performance to new. Replacement or repaired parts, or a replaced Product, will be warranted for only the unexpired portion of the original warranty or 90 days (whichever is greater).
3. Lake Shore warrants the Product only if the Product has been sold by an authorized Lake Shore employee, sales representative, distributor or an authorized Lake Shore original equipment manufacturer (OEM).
4. The Product may contain remanufactured parts equivalent to new in performance or may have been subject to incidental use when it is originally sold to the Purchaser.
5. The Warranty Period begins on the date the Product ships from Lake Shore's plant.
6. This limited warranty does not apply to problems with the Product resulting from (a) improper or inadequate installation (unless OT&V services are performed by Lake Shore), maintenance, repair or calibration, (b) fuses, software, power surges, lightning and non-rechargeable batteries, (c) software, interfacing, parts or other supplies not furnished by Lake Shore, (d) unauthorized modification or misuse, (e) operation outside of the published specifications, (f) improper site preparation or site maintenance (g) natural disasters such as flood, fire, wind, or earthquake, or (h) damage during shipment other than original shipment to you if shipped through a Lake Shore carrier.
7. This limited warranty does not cover: (a) regularly scheduled or ordinary and expected recalibrations of the Product; (b) accessories to the Product (such as probe tips and cables, holders, wire, grease, varnish, feedthroughs, etc.); (c) consumables used in conjunction with the Product (such as probe tips and cables, probe holders, sample tails, rods and holders, ceramic putty for mounting samples, Hall sample cards, Hall sample enclosures, etc.); or, (d) non-Lake Shore branded Products that are integrated with the Product.
8. TO THE EXTENT ALLOWED BY APPLICABLE LAW, THIS LIMITED WARRANTY IS THE ONLY WARRANTY APPLICABLE TO THE PRODUCT AND REPLACES ALL OTHER WARRANTIES OR CONDITIONS, EXPRESS OR IMPLIED, INCLUDING, BUT NOT LIMITED TO, THE IMPLIED WARRANTIES OR CONDITIONS OF MERCHANTABILITY AND FITNESS FOR A PARTICULAR PURPOSE. Specifically, except as provided herein, Lake Shore undertakes no responsibility that the products will be fit for any particular purpose for which you may be buying the Products. Any implied warranty is limited in duration to the warranty period. No oral or written information, or advice given by Lake Shore, its agents or employees, shall create a warranty or in any way increase the scope of this limited warranty. Some countries, states or provinces do not allow limitations on an implied warranty, so the above limitation or exclusion might not apply to you. This limited warranty gives you specific legal rights and you might also have other rights that vary from country to country, state to state or province to province.
9. Further, with regard to the United Nations Convention for International Sale of Goods (CISC,) if CISG is found to apply in relation to the goods covered by this limited warranty, which is specifically disclaimed by Lake Shore, then this limited warranty excludes warranties that: (a) the Product is fit for the purpose for which goods of the same description would ordinarily be used, (b) the Product is fit for any particular purpose expressly or impliedly made known to Lake Shore at the time of the purchase of the Product, (c) the Product is contained or packaged in a manner usual for such goods or in a manner adequate to preserve and protect such goods where it is shipped by someone other than a carrier hired by Lake Shore.
10. Lake Shore disclaims any warranties of technological value or of non-infringement with respect to the Product and Lake Shore shall have no duty to defend, indemnify, or hold harmless you from and against any or all damages or costs incurred by you arising from the infringement of patents or trademarks or violation or copyrights by the Product.
11. This limited warranty is not transferrable.
12. EXCEPT TO THE EXTENT PROHIBITED BY APPLICABLE LAW, NEITHER LAKE SHORE NOR ANY OF ITS SUBSIDIARIES, AFFILIATES OR SUPPLIERS WILL BE HELD LIABLE FOR DIRECT, SPECIAL, INCIDENTAL, CONSEQUENTIAL OR OTHER DAMAGES (INCLUDING LOST PROFIT, LOST DATA, OR DOWNTIME COSTS) ARISING OUT OF THE USE, INABILITY TO USE OR RESULT OF USE OF THE PRODUCT, WHETHER BASED IN WARRANTY, CONTRACT, TORT OR OTHER LEGAL THEORY, REGARDLESS WHETHER OR NOT LAKE SHORE HAS BEEN ADVISED OF THE POSSIBILITY OF SUCH DAMAGES. PURCHASER'S USE OF THE PRODUCT IS ENTIRELY AT PURCHASER'S RISK. SOME COUNTRIES, STATES AND PROVINCES DO NOT ALLOW THE EXCLUSION OF LIABILITY FOR INCIDENTAL OR CONSEQUENTIAL DAMAGES, SO THE ABOVE LIMITATION MAY NOT APPLY TO YOU.
13. This limited warranty gives the purchaser specific legal rights, and the purchaser may also have other rights that vary within or between jurisdictions where the Product is purchased and/or used. Some jurisdictions do not allow limitation in certain warranties, and so the above limitations or exclusions of some warranties stated above may not apply to all purchasers.
14. Except to the extent allowed by applicable law, the terms of this limited warranty do not exclude, restrict or modify the mandatory statutory rights applicable to the sale of the Product to you.

CERTIFICATION

Lake Shore certifies that this product has been inspected and tested in accordance with its published specifications and that this product met its published specifications at the time of shipment. The accuracy and calibration of this product at the time of shipment are traceable to the United States National Institute of Standards and Technology (NIST); formerly known as the National Bureau of Standards (NBS).

FIRMWARE LIMITATIONS

Lake Shore has worked to ensure that the firmware is as free of errors as possible, and that the results you obtain from the instrument are accurate and reliable. However, as with any computer-based software, the possibility of errors exists.

In any important research, as when using any laboratory equipment, results should be carefully examined and rechecked before final conclusions are drawn. Neither Lake Shore nor anyone else involved in the creation or production of this firmware can pay for loss of time, inconvenience, loss of use of the product, or property damage caused by this product or its failure to work, or any other incidental or consequential damages. Use of our product implies that you understand the Lake Shore license agreement and statement of limited warranty.

FIRMWARE LICENSE AGREEMENT

The firmware in this instrument is protected by United States copyright law and international treaty provisions. To maintain the warranty, the code contained in the firmware must not be modified. Any changes made to the code is at the user's risk. Lake Shore will assume no responsibility for damage or errors incurred as result of any changes made to the firmware.

FIRMWARE LICENSE AGREEMENT CONTINUED

Under the terms of this agreement you may only use the firmware as physically installed in the instrument. Archival copies are strictly forbidden. You may not decompile, disassemble, or reverse engineer the firmware. If you suspect there are problems with the firmware, return the instrument to Lake Shore for repair under the terms of the Limited Warranty specified above. Any unauthorized duplication or use of the firmware in whole or in part, in print, or in any other storage and retrieval system is forbidden.

TRADEMARK ACKNOWLEDGMENT

Many manufacturers and sellers claim designations used to distinguish their products as trademarks. Where those designations appear in this manual and Lake Shore was aware of a trademark claim, they appear with initial capital letters and the TM or [®] symbol. MeasureReady[®], CalCurve[™], Cernox[®], SoftCal[™], Rox[™], 2Dex[™], Tilt-View[™], and TruZero[™] are trademarks of Lake Shore Cryotronics, Inc. Java[™] is a registered trademark of Sun Microsystems, Inc. of Santa Clara, CA. LabVIEW[®] is a registered trademark of National Instruments. Mac[®] is a registered trademark of Apple, Inc., registered in the U.S and other countries. Microsoft Windows[®], Excel[®], and Windows Vista[®] are registered trademarks of Microsoft Corporation in the United States and other countries. Stycast[®] is a trademark of Henkel IP & Holding GMBH. WinZip[™] is a registered trademark of Corel Corporation. USB Type-C[™] and USB-C are trademarks of USB Implementers Forum.

COMPLIANCE AND CERTIFICATIONS

See <https://www.lakeshore.com/compliance/>.

Copyright 2018–2026 Lake Shore Cryotronics, Inc. All rights reserved. No portion of this manual may be reproduced stored in a retrieval system, or transmitted, in any form or by any means, electronic, mechanical, photocopying, recording, or otherwise, without the express written permission of Lake Shore.

Electromagnetic Compatibility (EMC) for the F71/F41 Teslameter

Electromagnetic Compatibility (EMC) of electronic equipment is a growing concern worldwide. Emissions of and immunity to electromagnetic interference is now part of the design and manufacture of most electronics. To qualify for the CE Mark, the teslameter meets or exceeds the requirements of the European Radio Equipment Directive 2014/53/EU.

The instrument was tested under normal operating conditions with sensor and interface cables attached. If the installation and operating instructions in this user's manual are followed, there should be no degradation in EMC performance.

Exposure to RF interference greater than that found in a typical laboratory environment may disturb the sensitive measurement circuitry of the instrument.

Pay special attention to instrument cabling. Improperly installed cabling may defeat even the best EMC protection. For the best performance from any precision instrument, follow the grounding and shielding instructions in the user's manual. In addition, the installer of the instrument should consider the following:

- Shield measurement and computer interface cables.
- Leave no unused or unterminated cables attached to the instrument.
- Make cable runs as short and direct as possible. Higher radiated emissions are possible with long cables.
- Do not tightly bundle cables that carry different types of signals.

Table of Contents

Chapter 1: Introduction	1.1 Overview	1	
	1.2 Features	1	
	1.3 Connectivity and Usability—Communication Options	2	
	1.3.1 Physical Connectivity	2	
	1.4 Hall Probe Selection	2	
	1.5 Specifications	3	
	1.6 Safety Summary and Symbols	4	
Chapter 2: Installation	2.1 General	7	
	2.2 Inspection and Unpacking	7	
	2.3 Front Panel	8	
	2.3.1 TiltView™ Touchscreen	8	
	2.4 Rear Panel	9	
	2.4.1 Field Control Module	10	
	2.4.2 Line Input Assembly	10	
	2.4.3 Digital I/O Port	11	
	2.4.4 Probe Input Connector	11	
	2.4.5 Analog Output	12	
	Chapter 3: Operation	3.1 General	13
		3.2 Instrument Power	13
3.3 Display Overview		13	
3.3.1 Home Screen		13	
3.4 Basic Operation		14	
3.4.1 Measurement Modes		14	
3.4.2 Averaging Window		16	
3.4.3 Autorange and Range Selection		17	
3.4.4 Field		18	
3.4.5 Frequency (AC modes only)		18	
3.4.6 Max Hold Function		19	
3.4.7 Relative Measurement		19	
3.4.8 Temperature Measurement		20	
3.4.9 Screen Lock		20	
3.5 Advanced Operation		21	
3.5.1 Sensor Information		21	
3.5.2 Field Control (optional)		22	
3.5.3 Buffered Data Streaming		27	
3.5.4 Analog Output		27	
3.5.5 Qualifier		29	
3.5.6 Digital I/O		31	
3.5.7 Temperature Compensation		34	
3.5.8 Cryogenic Operation		35	
3.5.9 Probe High-Frequency Operation		36	
3.5.10 Field Units		36	
3.5.11 Configurable Filters		37	
3.5.12 System Settings		39	
3.5.13 Reset		42	
3.5.14 Firmware Updates		44	
3.5.15 Live Plotting		46	
3.6 Probes	47		
3.6.1 General Probe Information	47		

	3.6.2 Probe Types	48
	3.6.3 Installation	50
	3.6.4 Operation	53
Chapter 4: Computer Interface Operation	4.1 General	55
	4.2 Standard Commands for Programmable Instruments	55
	4.2.1 Command Types	55
	4.2.2 Queries	56
	4.2.3 Optional Commands	56
	4.2.4 Short and Long Form	56
	4.2.5 Number Suffix	56
	4.2.6 Multiple Commands in a Single Message	56
	4.2.7 Terminators	57
	4.2.8 Message Flow Control	57
	4.3 Status and Error Reporting	58
	4.3.1 Status System Overview	58
	4.3.2 Register Details	60
	4.3.3 Error Messages	64
	4.4 Remote Interfaces	65
	4.4.1 USB	65
	4.4.2 Ethernet	66
	4.4.3 SCPI over TCP	69
	4.4.4 GPIB	69
	4.5 Command Summary	70
	4.5.1 Common Commands	70
	4.5.2 SCPI Subsystem Commands	73
Chapter 5: Probes and Accessories	5.1 General	81
	5.2 Models	81
	5.3 Accessories	81
	5.4 Rack Mounting	82
Chapter 6: Service	6.1 Overview	83
	6.2 General Troubleshooting	83
	6.3 USB Troubleshooting	83
	6.3.1 New Installation	83
	6.3.2 Existing Installation No Longer Working	83
	6.3.3 Intermittent Lockups	84
	6.4 Line Voltage	84
	6.5 Error and Status Messages	84
	6.6 System Troubleshooting	85
	6.6.1 Factory Reset	85
	6.6.2 Calibration Procedure	85
	6.7 Rear Panel Connector Definitions	86
	6.8 Summary of Internal Memory Devices	90
	6.9 Technical Inquiries	91
	6.9.1 Contacting Lake Shore	91
	6.9.2 Return of Equipment	91
	6.9.3 RMA Valid Period	92
	6.9.4 Shipping Charges	92
	6.9.5 Restocking Fee	92

Chapter 1: Introduction

1.1 Overview

Perfect for measuring magnetic fields in a wide variety of applications, Lake Shore's F71 and F41 teslameters with FP Series probes offer a new level of precision, convenience, and dependability. Some applications include:

- Scientific and materials research
- Quality control for magnet manufacturing and assemblies
- Electromagnet system control
- Magnetizing pulse capture
- Stray field detection and safety
- Electric motor design
- High resolution magnetic field mapping

1.2 Features

Features of the F71 and F41 teslameters include:

- DC and RMS measurement
- Peak to peak measurement
- Autoranging
- Variable averaging window
- Min/Max hold
- Relative readings
- Temperature compensation
- Frequency measurement of field and filtering
- TruZero™ technology to reduce measurement noise and offset
- TiltView™ touchscreen for improved viewing angles
- Smaller, ultra-thin Hall sensor active areas
- Multiple probe types to suit your application
- Zero warm-up time
- Isolated input and output relays
- Analog Hall voltage output
- Corrected field reading voltage output
- 3-year standard warranty
- High-speed data acquisition
- Field control option
- USB and Ethernet connectivity
- GPIB with MR-GPIB-USB adapter
- Pass/fail mode for quality control

For full feature information, please see our website:

<https://www.lakeshore.com/teslameters>

1.3 Connectivity and Usability—Communication Options

1.3.1 Physical Connectivity

USB and Ethernet connectivity provide convenient integration with systems using LabVIEW™, IVI.NET, Python, and other software. Interfacing is straightforward using IVI class drivers and industry-standard SCPI commands.

- *USB computer interface*: provides direct serial communication by emulating a standard RS-232 connection
- *Ethernet*: allows full control and reporting throughout an IP network
- *GPIB adapter*: available for use with MeasureReady® instruments, this adapter provides GPIB communication to instruments that don't have built-in GPIB. For more information, see: <https://www.lakeshore.com/products/product-detail/measureready/gpib-adapter/>



Lake Shore teslameters sold prior to August 2020 also included Wi-Fi capability. Please see: <https://www.lakeshore.com/instruments-wi-fi-addendum.pdf/>.

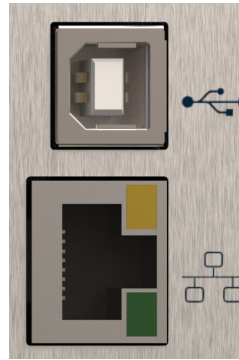

FIGURE 1-1 Communications connections

1.4 Hall Probe Selection

Full details on FP Series probes are provided on our website. Please see: <https://www.lakeshore.com/products/categories/overview/magnetic-products/hall-probes/fp-series-hall-probes>.

1.5 Specifications

Full specifications about the F71/F41 teslameter are provided on our website. Please see the Technical Specifications page at <https://www.lakeshore.com/teslameters>.

Feature	Description
Power requirement	100 V to 240 V (universal input), 50 Hz or 60 Hz, 30 VA
Size	216 mm wide × 87 mm high × 369 mm deep (8.5 in × 3.4 in × 14.5 in), half rack
Weight	3.2 kg (7 lb)
Approval	CE mark, UKCA
Operating conditions	
Rated accuracy	23 °C ±5 °C and <70% relative humidity non-condensing
Reduced accuracy	-20 °C to 70 °C, <90% relative humidity non-condensing
Instrument max field exposure	10 mT (100 G) DC, 1 mT (10 G) RMS

TABLE 1-1 Key specifications

1.6 Safety Summary and Symbols

Observe these general safety precautions during all phases of instrument operation, service, and repair. Failure to comply with these precautions or with specific warnings elsewhere in this manual violates safety standards of design, manufacture, and intended instrument use. Lake Shore Cryotronics, Inc. assumes no liability for user failure to comply with these requirements.

The F71/F41 teslameter protects the operator and surrounding area from electric shock or burn, mechanical hazards, excessive temperature, and spread of fire from the instrument. Environmental conditions outside of the conditions below may pose a hazard to the operator and surrounding area.

- Indoor use
- Altitude to 2000 m
- -20 °C to 70 °C, <90% relative humidity non-condensing
- Overvoltage category II
- Pollution degree 2
- Mains fluctuations up to $\pm 10\%$

Ground the Instrument

To minimize shock hazard, the instrument is equipped with a 3-conductor AC power cable. Plug the power cable into an approved 3-contact electrical outlet or use a 3-contact adapter with the grounding wire (green) firmly connected to an electrical ground (safety ground) at the power outlet. The power jack and mating plug of the power cable meet Underwriters Laboratories (UL) and International Electrotechnical Commission (IEC) safety standards.

Ventilation

The instrument has ventilation holes in its side covers. Do not block these holes when the instrument is operating.

Do Not Operate in an Explosive Atmosphere

Do not operate the instrument in the presence of flammable gases or fumes. Operation of any electrical instrument in such an environment constitutes a definite safety hazard.

Keep Away from Live Circuits

Operating personnel must not remove instrument covers. Refer component replacement and internal adjustments to qualified maintenance personnel. Do not replace components with power cable connected. To avoid injuries, always disconnect power and discharge circuits before touching them. Do not position the instrument so that it is difficult to disconnect the power cord.

Child Safety

This equipment is not suitable for use in locations where children are likely to be present.

Do Not Substitute Parts or Modify Instrument

Do not install substitute parts or perform any unauthorized modification to the instrument. Return the instrument to an authorized Lake Shore Cryotronics, Inc. representative for service and repair to ensure that safety features are maintained. If the equipment is used in a manner not specified by the manufacturer, the protection provided by the equipment may be impaired.

Cleaning

Do not submerge instrument. Clean only with a damp cloth and mild detergent. Exterior only.

Desktop Installation

When installing the instrument in a desktop environment, ensure it is mounted on a flat, level surface.

Improper Use

If the instrument is used in a manner that is not specified by Lake Shore, the safety protections provided by the instrument are no longer guaranteed, and may be impaired.













	Direct current (power line)		Equipment protected throughout by double insulation or reinforces insulation (equivalent to Class II of IEC 536—see Annex H)
	Alternating current (power line)		CAUTION: High voltages; danger of electric shock; background color: yellow; symbol and outline: black
	Alternating or direct current (power line)		CAUTION or WARNING: See instrument documentation; background color: yellow; symbol and outline: black
	Three-phase alternating current (power line)		
	Earth (ground) terminal		
	Protective conductor terminal		
	Frame or chassis terminal		
	On (supply)		
	Off (supply)		

FIGURE 1-2 Safety symbols

Chapter 2: Installation

2.1 General

This chapter provides general installation instructions for the F71/F41 teslameter. Please read this entire chapter before installing the instrument and powering it on to ensure the best possible performance and to maintain safety.

2.2 Inspection and Unpacking

Inspect shipping containers for external damage before opening them. Photograph any container that has significant damage before opening it. Inspect all items for both visible and hidden damage that occurred during shipment. If there is visible damage to the contents of the container, contact the shipping company and Lake Shore immediately, preferably within five days of receipt of goods, for instructions on how to file a proper insurance claim. Lake Shore products are insured against damage during shipment, but a timely claim must be filed before Lake Shore will take further action. Procedures vary slightly with shipping companies. Keep all damaged shipping materials and contents until instructed to either return or discard them.

Open the shipping container and keep the container and shipping materials until all contents have been accounted for. Check off each item on the packing list as it is unpacked. Instruments themselves may be shipped as several parts. The items included with the F71/F41 teslameter are listed below. Contact Lake Shore immediately if there is a shortage of parts or accessories. Lake Shore is not responsible for any missing items if not notified within 60 days of shipment.

If you need to return the instrument for recalibration, replacement or repair, a return authorization (RMA) number must be obtained from a Lake Shore representative. Refer to section 6.9.3 for the Lake Shore RMA procedure.

Probes are shipped in cardboard containers and are often included in the instrument shipping carton. Please retain the probe container for probe storage. This will help protect the delicate probe from being damaged.

Items Included with F71/F41 teslameter:

- F71/F41 teslameter
- 6-pin terminal block, two count
- Line power cord
- USB A to USB-Type C™ adapter
- Quick Start Guide

2.3 Front Panel

The F71/F41 teslameter has a 5 in capacitive touch, color TFT display with LED back-light, which is used to control the instrument and display relevant output settings and the instrument state.



FIGURE 2-1 F71/F41 teslameter front panel

	Connector	Description
1	Power button	The power button turns the instrument power on and off.
2	TiltView™ touchscreen	The screen adjusts from a 0° to a 37° viewing angle, whether mounted in a rack or on a bench top.

TABLE 2-1 Front panel connections

2.3.1 TiltView™ Touchscreen

The TiltView™ feature makes seeing the screen and operating the touch interface comfortable from any angle, even when mounted in a rack. The screen adjusts from a 0° to a 47° viewing angle, whether mounted in a rack or on a bench top.

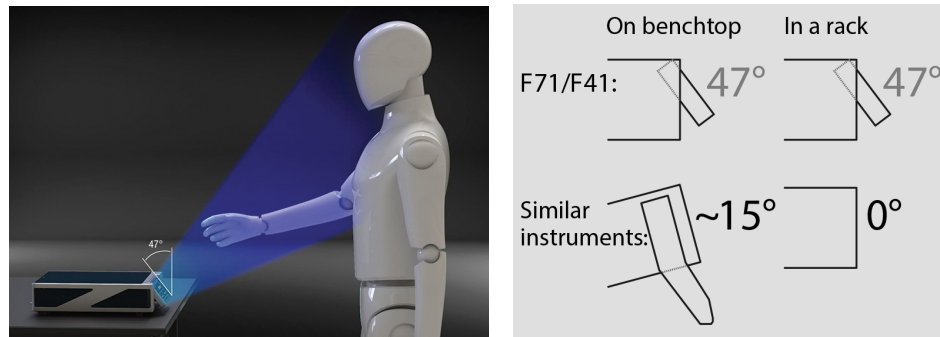

FIGURE 2-2 TiltView™ angle comparison

2.4 Rear Panel

This section provides a description of the F71/F41 teslameter rear panel connections.

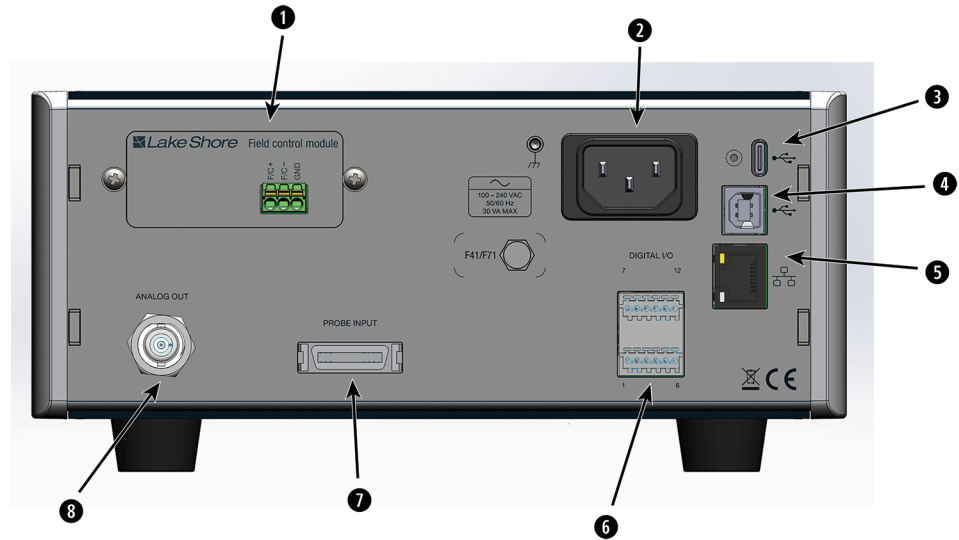

FIGURE 2-3 F71/F41 teslameter rear panel

	Connector	Description
1	Option card slot	Field control option
2	Line input assembly	Power is provided through the line input assembly.
3	USB Type-C™ interface	Connect to USB devices such as flash drives. Currently, only used for firmware updates, and to attach the MR-GPIB-USB adapter.
4	USB serial communications interface	The USB interface is provided to connect with most modern computers.
5	RJ-45 Ethernet interface	The Ethernet interface is provided to allow connection to a computer network.
6	Digital I/O port	For general purpose input/output connection or trigger output functionality. More information is provided in section 3.5.6.
7	Probe input connector	26-pin mini D-sub for Hall probes.
8	BNC analog output connector	Outputs the raw amplified Hall voltage signal. See section 2.4.5.

TABLE 2-2 Rear panel connections

2.4.1 Field Control Module

The F71/F41 teslameter can be fitted with a field control option card that provides a high precision control voltage output for electromagnet systems. The stable and accurate probe field measurement completes the closed-loop control configuration. The instrument, probe, power supply, magnet, and control parameters play important roles in establishing stable field control. See section 3.5.2.



Field control is only available for single-axis probes. The averaging window does not affect field control behavior.

The field control option card's only connection is to the J4 connector on the main board. See the separate installation instructions that came with the option card if you are adding the option card yourself.

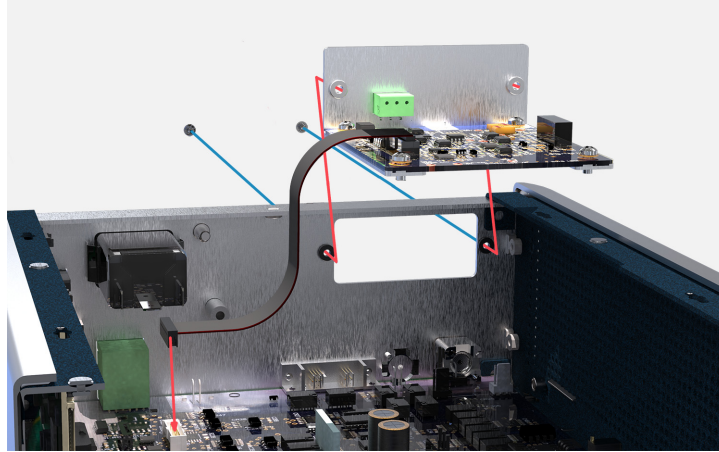

FIGURE 2-4 Field control option card placement

2.4.2 Line Input Assembly

This section describes how to properly connect the F71/F41 teslameter to line power. Please follow these instructions carefully to ensure proper operation of the instrument and the safety of operators.



FIGURE 2-5 Line input assembly

2.4.2.1 Power Cord

The F71/F41 teslameter includes a 3-conductor power cord that mates with the IEC 320-C14 line cord receptacle. Line voltage is present on the two outside conductors and the center conductor is a safety ground. The safety ground attaches to the instrument chassis and protects the user in case of a component failure.



Always plug the power cord into an easily accessible, properly grounded receptacle to ensure safe instrument operation.



Do not position the instrument so that it is difficult to disconnect the power cord.



If the power supply cord is damaged or lost, it must be replaced. Contact Lake Shore for a replacement to ensure proper voltage, current and type of cord.

2.4.3 Digital I/O Port

See section 3.5.6 and section 6.7 for features of the digital I/O port.

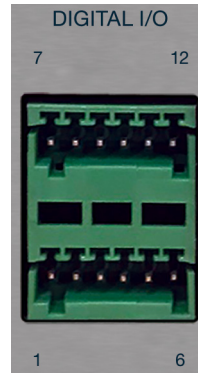

FIGURE 2-6 Digital I/O port

2.4.4 Probe Input Connector

This section describes the probe input connector. See section 3.6.3.3 and section 6.7 for further information.

The Lake Shore Hall probe plugs into the 26-pin mini D-sub socket on the rear panel. Align the probe connector with the probe input socket and push straight in. The connector is push-to-lock. You should hear a clicking sound if the connector is fully seated.

An electrically erasable programmable read only memory (EEPROM chip) is included in each probe. The EEPROM chip stores specific information that the teslameter requires for operation. The information includes serial number, probe sensitivity, field compensation data, temperature compensation data, and calibration data. When a new probe is connected, the instrument reads parameters from probe memory and the probe is ready to use. A new probe can be connected at any time even while the instrument is turned on.

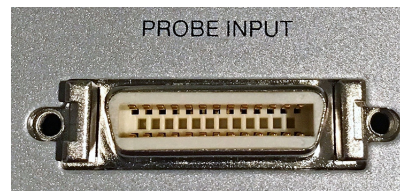

FIGURE 2-7 Probe input connector

2.4.4.1 Probe Handling

To avoid damage and for best results during use, probes have a number of handling and accuracy requirements that must be observed.



Some probes used with the teslameter have conductive parts. Never probe near exposed live voltage. Personal injury and damage to the instrument may result.

Force should never be applied to the tip of the probe. On all probes, do not pinch or allow cables to be struck by any heavy or sharp object. Damaged or severed cables may be returned to Lake Shore for repair but probes are not always repairable.

The cardboard and foam container that Lake Shore probes are shipped in should be retained for probe storage and for return shipping for periodic probe recalibration. For additional probe details, please see section 3.6.

2.4.5 Analog Output

The F71/F41 teslameter has an analog output that can provide a DC voltage proportional to the corrected field measurement or the amplified raw Hall voltage. This setting can be configured through the front panel or through the remote interfaces. Connect an oscilloscope or data acquisition system to the output BNC to analyze the readings.

CAUTION

The shell of the analog output BNC is connected directly to the instrument ground. Connecting it incorrectly could cause additional noise in the measurement or damage to the electronics.

For further information, see section 3.5.4 and section 6.7.



FIGURE 2-8 *Analog output connector*

NOTE

The analog output can provide up to $\pm 15V$.

Chapter 3: Operation

3.1 General

This chapter provides instructions for the operating features of the F71/F41 teslameter.

3.2 Instrument Power

Refer to the table below for details on the power button operation.

Power mode	Power button LED	Enter mode by:	Return to ON by:
ON	On	Plug the instrument into an outlet	N/A
SLEEP	Slow pulse	Short press of the power button	Short press of the power button
STANDBY	Off	Hold the power button until the screen turns off (up to 10 seconds)	Hold the power button until the screen turns on (1-2 seconds)

TABLE 3-1 Instrument power

- **ON:** normal operation.
- **SLEEP:** lower power state with the main board powered down, but operating system remains active for wake-up.
- **STANDBY:** both the main board and OS are shut down. Requires full boot up sequence when turning back on.

3.3 Display Overview

This section describes the various displays of your teslameter.

3.3.1 Home Screen

When the teslameter is turned on, the Home screen is displayed.



The screens you see may differ, depending on your software version. Some screens are scrollable.

Settings menu

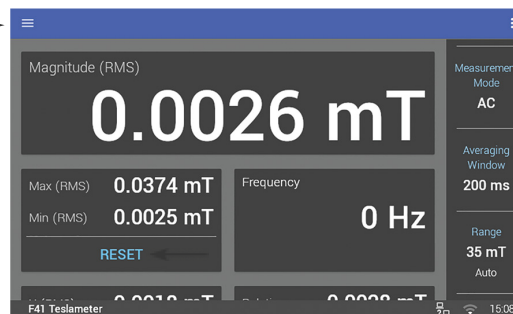

Status bar

Quick access settings

FIGURE 3-1 Home screen

3.4 Basic Operation

The Home screen displays readings such as magnitude, max hold, relative, XYZ (F71), and frequency. Touch a box on the screen to navigate to a detail screen containing more information.

The following quick access settings are also available on the Home screen:

- Measurement Mode
- Averaging Window
- Range

3.4.1 Measurement Modes

The F71/F41 teslameter can be configured for DC, AC, or high-frequency measurements.

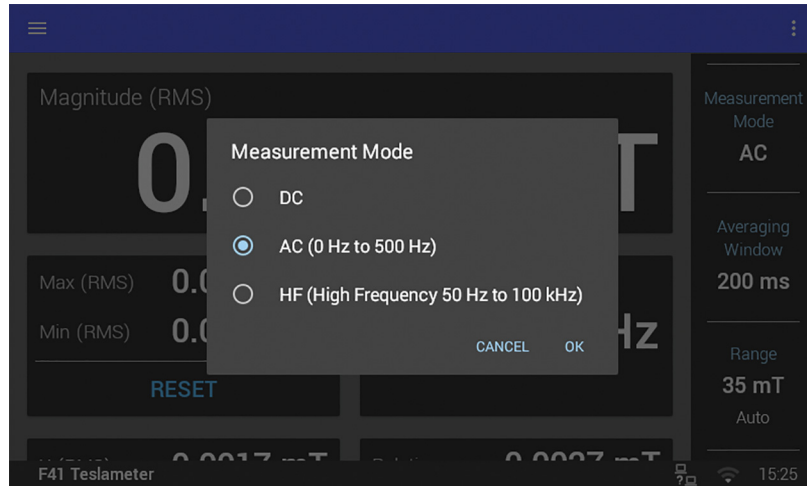

FIGURE 3-2 Measurement Mode

3.4.1.1 DC Measurement Mode

When absolute field values are desired, DC is the recommended measurement mode. Averaging windows as short as 10 ms (100 readings per second) are possible, so even fast moving fields can be characterized using DC mode. In DC measurement mode, the display shows the measured DC field, the DC max hold, and the DC relative measurement.

3.4.1.2 AC Measurement Mode

AC mode offers the highest level of accuracy for periodic fields. However, it is only capable of measuring accurately over a limited range of frequencies. This is because AC mode uses the TruZero™ measurement technique, delivering improved accuracy at the expense of high-frequency capabilities. AC mode calculates DC level, AC RMS component, peak values, and crest factor.

- *RMS*: the root mean square of the AC component of the field.
- *Peak to peak*: the difference between the smallest and largest samples acquired during the averaging window.
- *Crest factor*: the ratio between the largest peak value and the RMS measurement.
- *DC offset*: the component of the field that is not changing. This includes fields that have a period longer than the averaging window.

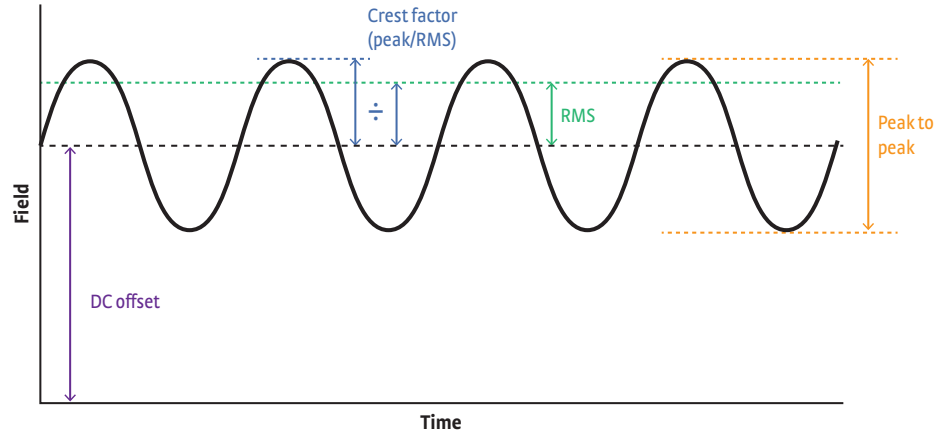

FIGURE 3-3 Available field measurements in AC mode

The DC level is the rolling average field measured over the averaging window period (see section 3.4.2). The instrument subtracts this DC level from the RMS measurement, meaning the RMS measurement only includes the AC component of the field.

For best results, select an averaging window 10 times the period of the field measured. This ensures stable DC values and accurate AC values.

For example:

A 50 Hz signal has a 20 ms period. So the averaging window should be no less than 200 ms. Longer averaging windows will work even better.

Slow AC signals need a very long averaging window in AC mode. In these cases, DC mode with a short averaging window may work better. Buffered data streaming (see section 3.5.3) allows for a sample rate up to 100 Hz (10 ms averaging window) in DC mode. RMS and peak values can then be calculated using the collected data.

For example:

In AC mode, a 1 Hz signal requires a 10 s averaging window for accurate measurement. In some applications this may be too slow. Instead, DC mode with an averaging window of 10 ms will provide 100 samples per signal period.

3.4.1.3 High-Frequency Measurement Mode

High-frequency (HF) mode sacrifices accuracy and the ability to measure DC values to take measurements as fast as possible. The instrument samples at 200,000 readings per second in high-frequency mode. However, there are many factors limiting measurement accuracy at high frequencies. See the “High Frequency Measurement” white paper (coming soon, the Downloads page at <https://www.lakeshore.com/teslameter>) for a detailed explanation.

High-frequency mode disables signal modulation, allowing the use of the analog out connection to view the AC waveform in real-time. Connect the analog out to an oscilloscope to monitor pulsed or high-frequency fields. See section 2.4.5 for voltage conversion details.

In high-frequency mode, the instrument has a typical frequency response shown in the figure below. This bandwidth may vary to some degree between instruments.

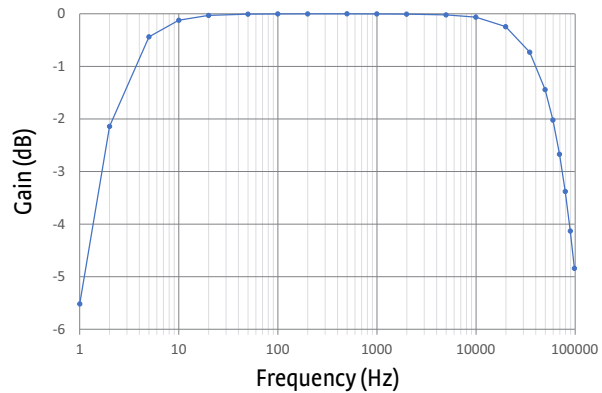

FIGURE 3-4 High-frequency mode instrument frequency response



Each probe has its own frequency response.

3.4.2 Averaging Window

Time interval settings can be set from 10 ms to 10 s, in increments of 10 ms. The averaging window is a rolling average, with the screen retaining a 5 rdg/s update rate.

There are several purposes of the averaging window:

- Selecting how much smoothing is applied to the measurement without altering the measurement update rate.
- Adjusting the accuracy of the AC and DC components of a measurement in AC mode (section 3.4.1.2).
- Setting the measurement buffer interval when using the streaming data buffer feature over SCPI (section 3.5.3).

The fundamental measurement for the teslameter is 10 ms, with all averaging windows being an average of a certain number of these 10 ms measurement steps. For example, the 200 ms window averages the previous 20 measurement samples. The rolling average updates with each 10 ms measurement regardless of the window. For example, a 10 s averaging window could be queried once every second and each returned value would be an average of the previous 10 s.

Averaging windows of less than 200 ms will not result in a faster screen update rate, but can be queried remotely to capture the higher-speed data.

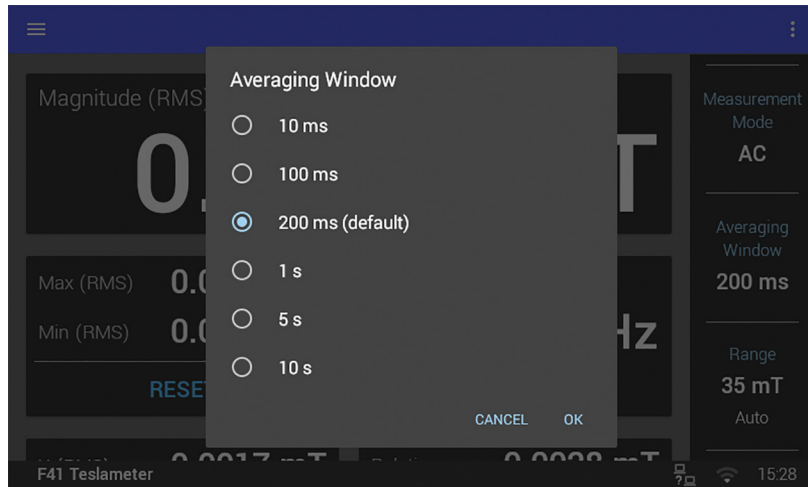

FIGURE 3-5 Averaging Window

Although readings are immediately available following a major settings change (not including range change), it is recommended to wait at least one averaging window's period of time before recording readings. This allows time for the rolling average to stabilize after being reset.

3.4.3 Autorange and Range Selection

The F71/F41 teslameter is equipped with an autoranging feature that will automatically select the appropriate range for the measured field. In some cases it may be desirable to manually select the field range. Autorange and manual range selection are accessible from the Range quick access setting. When manually selecting a range for an AC field in AC or high-frequency mode, select a range higher than the expected peak value of the field. The main display is RMS, which will be less than the peak values produced by the field.



Autorange is the default setting.

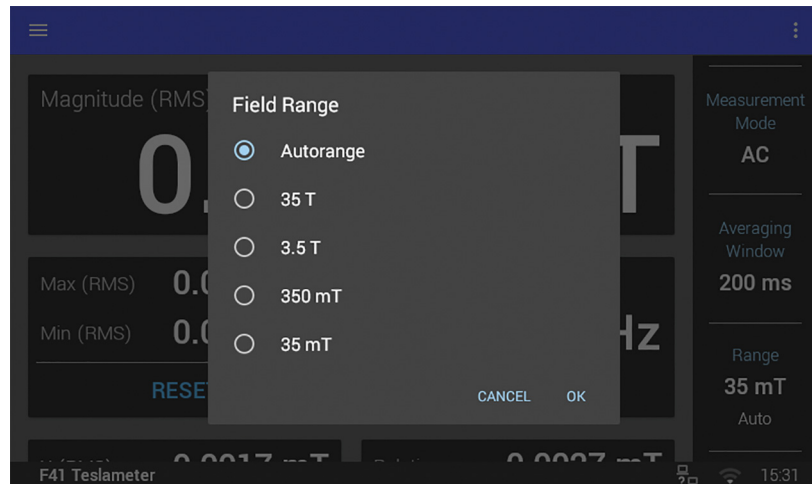

FIGURE 3-6 Range

3.4.4 Field

This detail screen can be accessed from the Home screen, or by navigating from another detail screen. This screen contains different information depending on the mode of operation. For a 3-axis probe, the magnitude value is defined as the square root of the sum of the squares of the three axes' measurements. This is also known as the vector sum. The figure below shows an example of the display in AC mode.

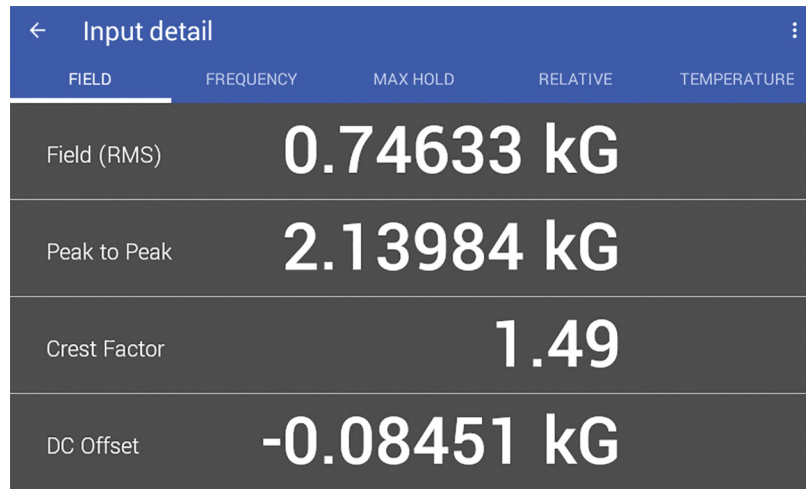

FIGURE 3-7 AC measurement detail

3.4.5 Frequency (AC modes only)

Frequency is calculated by counting DC value crossings. This value is most accurate when measuring a fairly consistent AC signal with a strong fundamental frequency and amplitude greater than 1% of range.

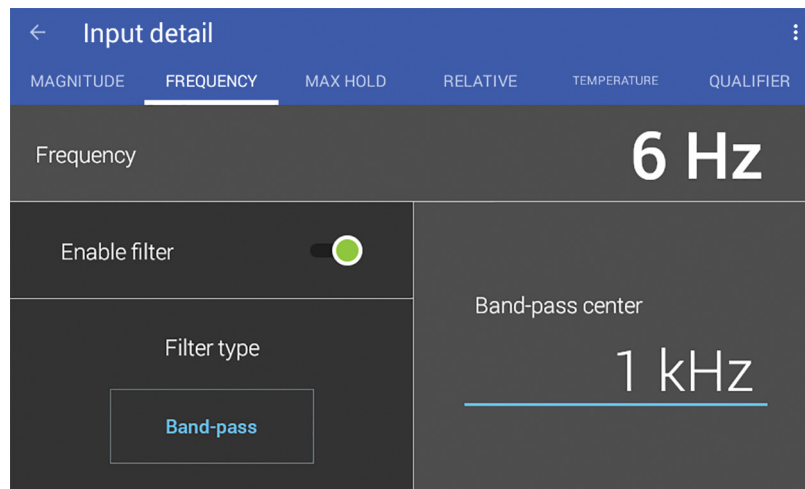

FIGURE 3-8 Frequency detail

3.4.6 Max Hold Function

The Max Hold function records maximum and minimum values, with the ability to reset these values to the present reading at any time. Accessing the detail screen will allow you to reset values individually.

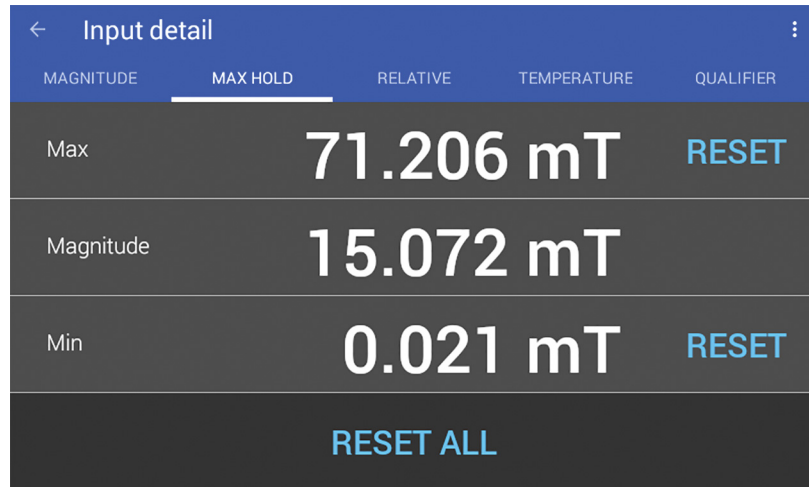

FIGURE 3-9 Max Hold detail

3.4.7 Relative Measurement

The Relative measurement allows you to take field measurements relative to a baseline field. The relative reading is equal to the present field value minus the baseline. The Relative mode applies to the DC reading in DC mode, and to the RMS reading in the AC and high-frequency modes.



The relative measurement does not interact with other features at this time.

Touch the Tare button on the screen to capture the present reading and set it as a new baseline. It is also possible to manually set a baseline through the detail screen. Touch the Clear button to set the baseline to zero.

TIP: This feature can be used to remove the small amount of TruZero™ residual offset if a 0 reading is desired when the probe is placed in a zero gauss chamber. Measure the residual offset with the probe in a zero gauss chamber and set the relative baseline to the average offset value.

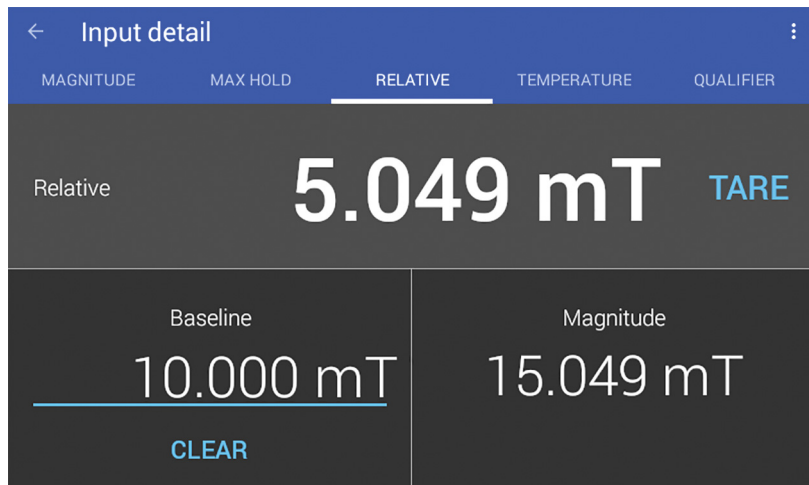

FIGURE 3-10 Relative measurement

3.4.8 Temperature Measurement

The temperature compensation detail screen displays the current temperature reading for the probe tip temperature sensor. Temperature compensation is on by default but can be turned off for troubleshooting, or set to manual to allow temperature inputs that are outside the standard operating range of the probe temperature sensor (0° to 90° C).

For more information on temperature compensation, see section 3.5.7.

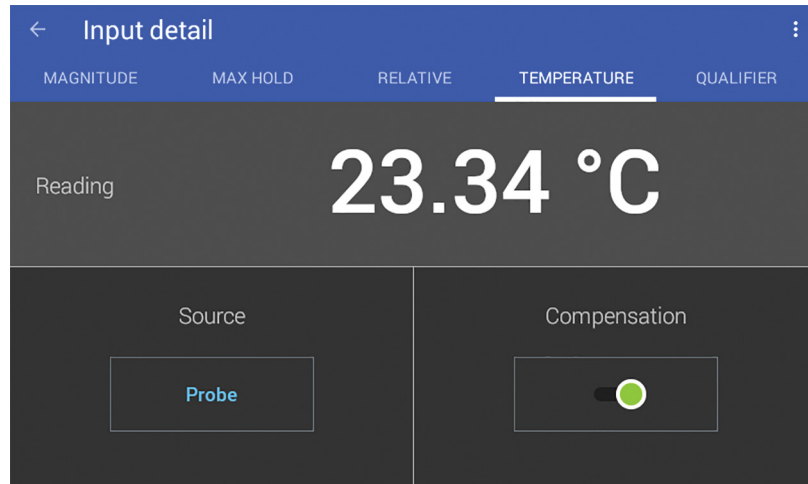

FIGURE 3-11 Temperature measurement

3.4.9 Screen Lock

The screen lock feature prevents accidental changes to parameter values. When the screen is locked, some parameter values may be viewed, but not changed, from the front panel.

To lock the screen:

1. Tap the action icon (three dots in the top right corner of the screen). A drop-down menu appears.
2. Tap **Lock**. A message indicating that the screen is locked appears in the status bar.

To unlock the screen:

1. Tap the lock icon in the top right corner of the screen.
2. Tap **UNLOCK** in the status bar. The screen unlocks.

3.5 Advanced Operation

The following sections explain the more advanced features of the F71/F41 teslameter. To find these settings, tap the Settings menu (top left corner of the screen) to access the navigation drawer, then select an option.

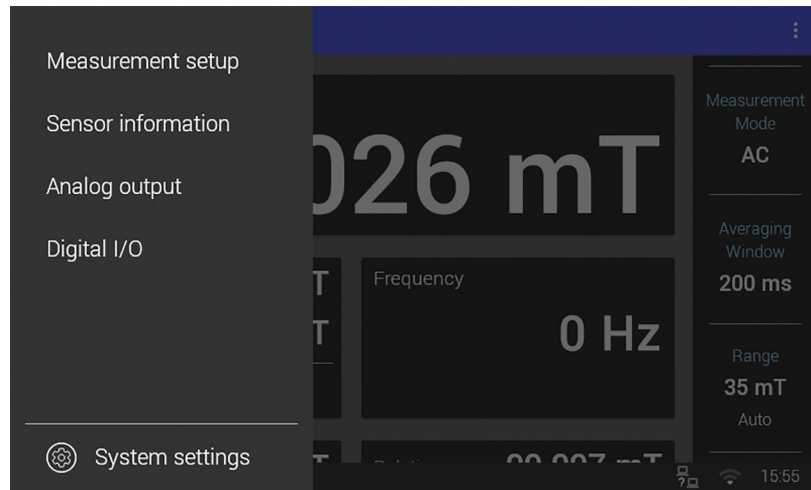

FIGURE 3-12 Navigation drawer

3.5.1 Sensor Information

The Sensor Information tab provides general information about the probe.

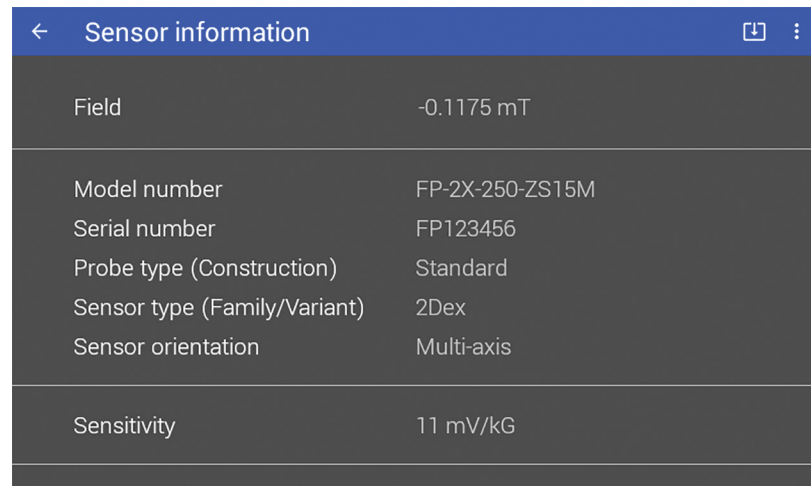

FIGURE 3-13 Sensor Information

Item	Description
Magnitude	The current magnitude reading.
Model number	The probe model number.
Serial number	The unique identifier for this specific probe assigned during manufacturing.
Probe type (Construction)	Information about the mechanical design of the probe.
Sensor type (Family/Variant)	The material family of the sensor.
Sensor orientation	The direction the sensor is facing, relative to the stem.
Sensitivity	Nominal sensitivity of the Hall sensor(s) in the probe at the probe's operating excitation current.
Thermistor present	Indicates whether there is a temperature sensor in the tip of the connected probe.
Probe temperature reading	Displays the current temperature of the probe, in °C.
Probe calibration data	Indicates whether the sensor data is fixed or able to be set by the user.
Last calibration date	The date and time the probe was last calibrated successfully at Lake Shore.

TABLE 3-2 Sensor information

3.5.2 Field Control (optional)

Field control options will only display when the field control module is installed. Field control is available only for DC measurements with single-axis probes. When Field Control is enabled, the Home screen will show different options including a quick access setting for Field Control.

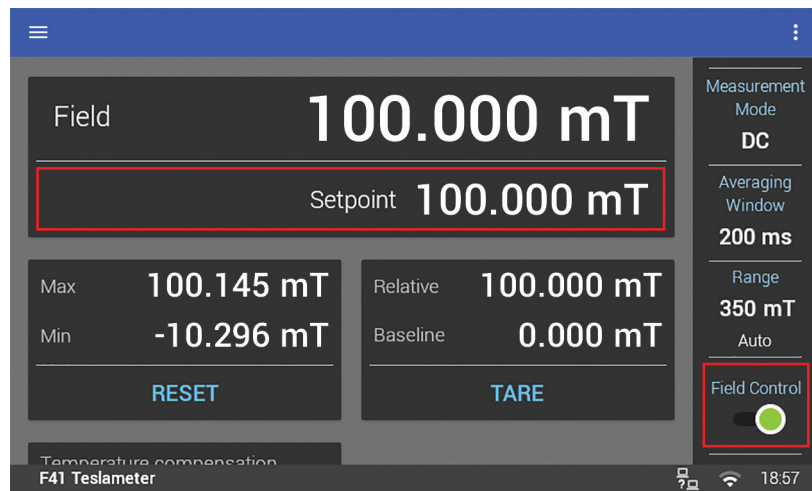

FIGURE 3-14 Home screen with Field Control

All field control settings can be accessed through the Settings menu (top left corner of the screen).

3.5.2.1 Power Supply Protection

Magnet power supplies can be damaged by a control voltage that is too large or by rapid changes in the control voltage. It is important to put limits on these values to avoid these problems.

3.5.2.1.1 Voltage Limit

The full span of the field control option card is $\pm 10V$. However some magnet power supplies are not designed to operate at those voltages, so a limit can be set on the output voltage. See FIGURE 3-19.

3.5.2.1.2 Maximum Slew Rate Limit

The slew rate is the rate of change in the output voltage of the field control option card. This rate can be limited to protect the magnet power supply. The Slew rate limit will be used even when a step change is requested (including when disabling field control while actively controlling).

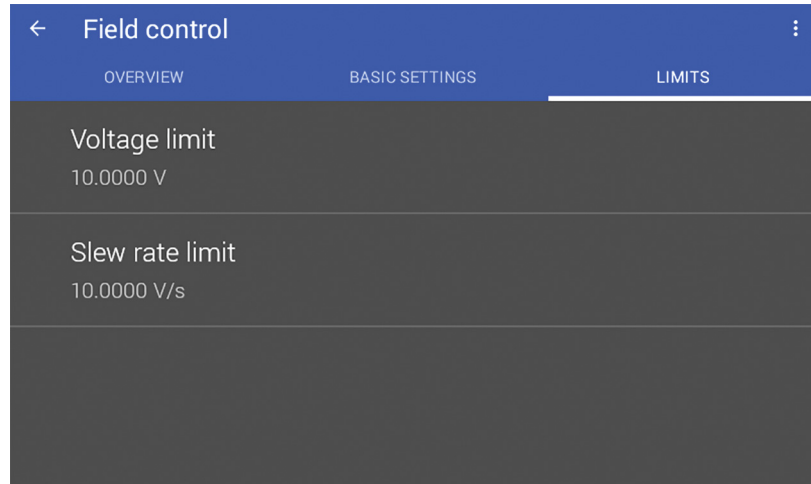

FIGURE 3-15 Field control limits

3.5.2.2 Open Loop Mode

In Open Loop mode, the control output voltage of the field control option card can be set directly by the user. This can be helpful in testing and characterizing the field control system before moving to Closed Loop control.

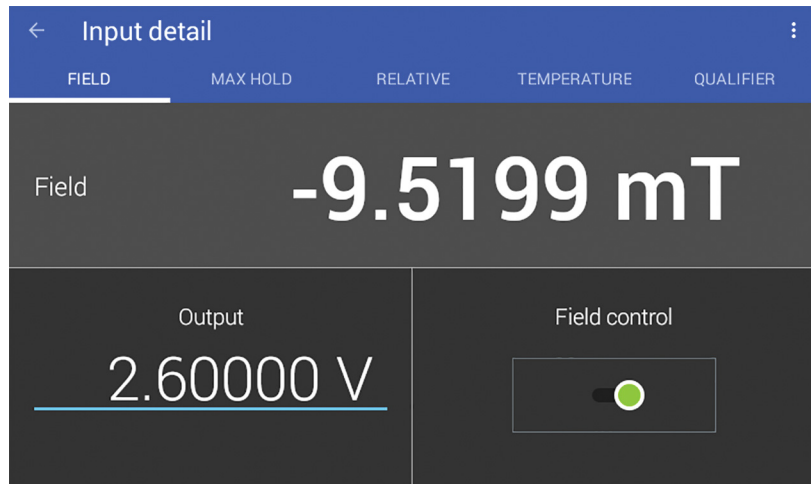

FIGURE 3-16 Open Loop mode

3.5.2.3 Closed Loop Mode

Closed Loop mode, sometimes called feedback control, is the control mode most often associated with field controllers. In this mode, the controller attempts to keep the measured magnetic field at exactly the user entered setpoint. To do this, feedback from the probe is used to calculate and actively adjust the field control option card analog voltage output. The teslameter uses a PI control algorithm to tune the controller for each unique system.

The PI control equation has two variable terms: proportional (P) and integral (I), see below. See FIGURE 3-17. Changing these variables for best control of a system is called tuning. The PI equation is:

$$Output = P \left[e + \frac{1}{I} \int (e) dt \right]$$

where the error (e) is defined as: $e = \text{Setpoint} - \text{Feedback Reading}$

3.5.2.3.1 Proportional (P)

The value of the proportional term is multiplied by the error (e) to produce the output value. The error is defined as the difference between the setpoint and feedback field measurement.

If proportional is acting alone, with no integral, there must always be an error or the output will go to zero. A great deal must be known about the magnet, power supply, and probe to compute the ideal P value. Most often the proportional setting is determined by trial and error. The proportional setting is part of the overall control loop gain, and so are the magnet, magnet gap, and power supply characteristics. The proportional setting will need to change if the hardware changes.

3.5.2.3.2 Tuning Proportional

The proportional setting is tied to the overall gain of the system. The gain of the power supply should be fairly constant over its entire range of operation, but the gain of the magnet changes with field. As the magnet approaches saturation, the amount of current needed to change the field a given amount increases substantially. No single value of P will be sufficient to maintain acceptable control over the entire range of magnet operation.

To find the correct proportional setting for a system, turn off the I setting and start with a low value for P, approximately 5 or 10. And set the control setpoint to some low, non-zero field (100 mT for example). If the field is oscillating, then P is too high and needs to be reduced. If the field is not oscillating, increase P by a factor of two until the system begins to oscillate. See FIGURE 3-17(a). Do not set the proportional setting so high that it causes violent oscillations. The appropriate value for P is one half of the value required for sustained oscillation. An even lower setting of one quarter may be desired for minimal overshoot. See FIGURE 3-17(b).

3.5.2.3.3 Integral

The integral term, also called reset, looks at error over time to build the integral contribution to the output.

$$Output = P \frac{1}{I} \int (e) dt$$

By adding the integral to proportional contributions, the error history will push the output towards a stable value. When the error is at zero, controlling at the setpoint, the output is held constant by the integral contribution. The integral setting (I) is more predictable than the proportional setting. It is related to the dominant time constant of the magnet. The integral term is set in seconds and a smaller setting creates a more active integrator.

3.5.2.3.4 Tuning Integral

When the proportional setting is chosen and the integral is turned off, the teslameter will control the field to some value below the setpoint. Setting the integral allows the control algorithm to gradually eliminate the difference in field by integrating the error over time. See FIGURE 3-17(d). An integral setting that is too low causes the field to take too long to reach the setpoint. An integral setting that is too high can create overshoot, which cannot be tolerated in many magnetic systems. An integral setting that is very high will eventually cause the field to oscillate.

Begin this part of the tuning process using the proportional setting found above, and enter an I setting of 100. If the field begins to oscillate, increase the I setting by a factor of two. Remember the integral term is set in seconds and a smaller setting creates a more active integrator. If the field is stable but never reaches the setpoint, the integral setting is too high and should be reduced by one half.

To verify the integral setting, make a few small (100 mT) changes in setpoint and watch the field react. Trial and error can help improve the integral setting by optimizing for experimental needs. Faster integrals, for example, get to the setpoint more quickly at the expense of greater overshoot.

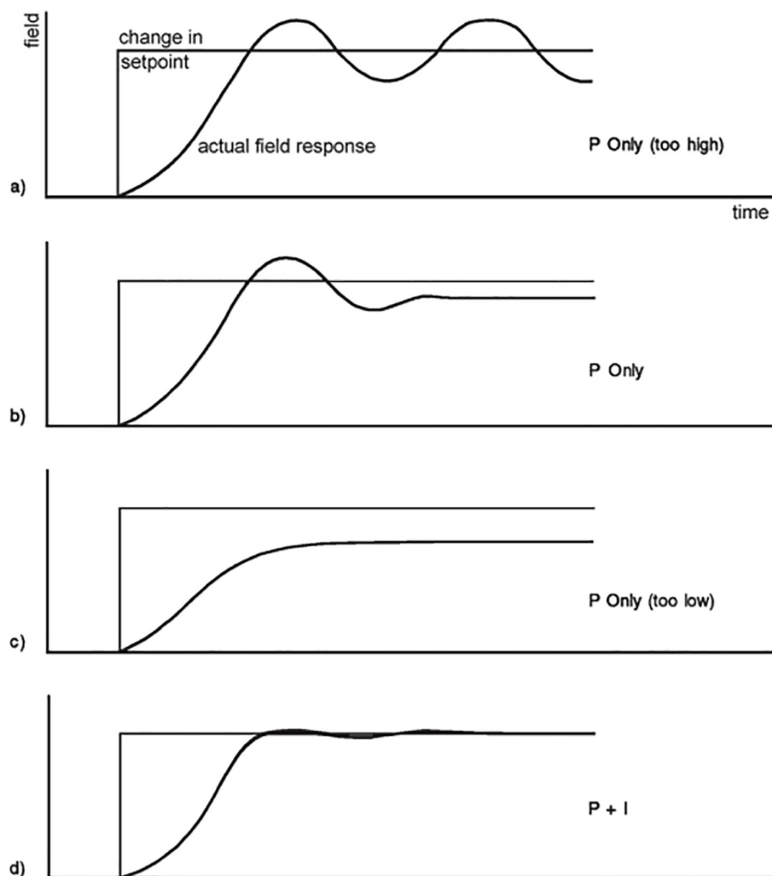

FIGURE 3-17 Examples of PI control

3.5.2.3.5 Ramp Rate

The setpoint ramp rate determines how quickly the Closed Loop field control will move from the previous setpoint to a newly configured setpoint. The ramp rate can be used to avoid overshoot or to sweep over a range of field values. The ramp rate is set in field units per second.



Setting the ramp rate to 0 disables ramping. Changes to the setpoint will behave like step changes.

Tap Field on the Home screen to go to the detail screen, where the PI values and setpoint can be configured. While the ramp rate is being set, “Ramping” will display on the detail screen and on the Home screen.

Swipe up on the screen to reveal the **Advanced Settings** button, which returns to the Field control Overview screen.

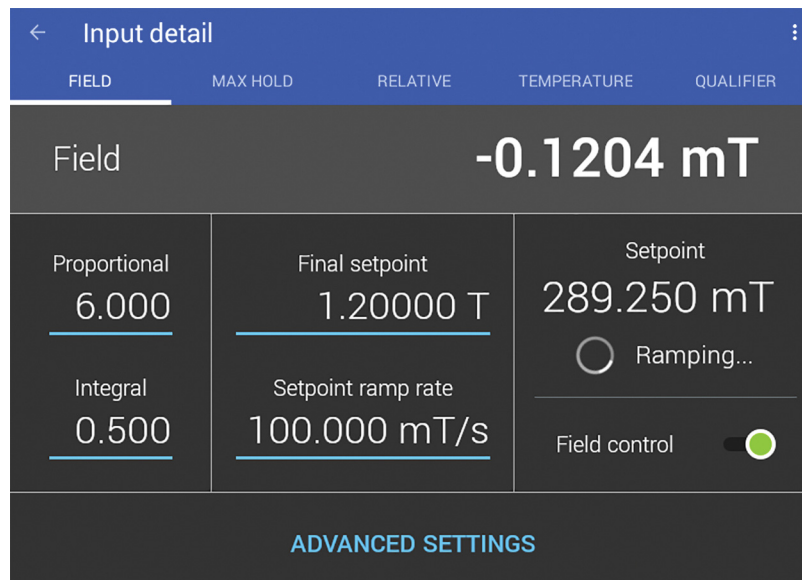

FIGURE 3-18 Ramp rate

A voltage limit warning will display on the detail screen and on the Home screen when the voltage control limit is reached.

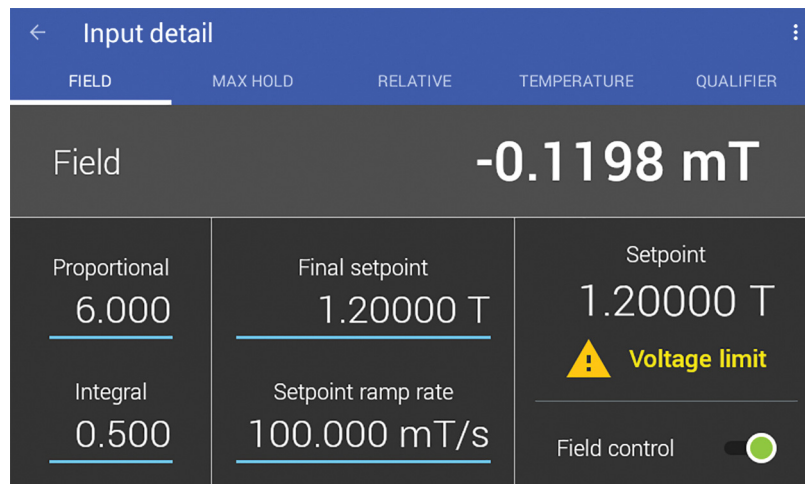

FIGURE 3-19 Voltage limit

3.5.2.3.6 MagnoTune™ Magnet System Tuning

MagnoTune™ is an advanced field control technique where the relationship between control voltage and field is characterized and used to greatly improve closed loop performance. On very large electromagnets, the relationship between supplied current and generated field strength is not linear, making it difficult to quickly ramp magnetic fields using a standard PI control loop. Linearization of the current/field relationship allows faster and more stable controlled field changes.

MagnoTune is a feature available through Lake Shore's MeasureLINK™-MCS software which creates a unique linearization for a given electromagnet configuration.

3.5.3 Buffered Data Streaming

The teslameter provides a buffer of measurements for applications where continuous data, high speed streaming, or digital input synchronization is desired. The buffer returns up to 128 of the most recent measurements in a comma separated format. Each measurement has a time stamp in an ISO 8601 format that is precise to the millisecond. When the buffer is queried, the data is cleared. To obtain continuous data, the buffer must be queried faster than it is filled. At a 10 ms averaging window the buffer is filled every 1.28 seconds, therefore it should be queried about every half second. For more information about buffer best practices, applications, and example code please see *Fast Magnetic Field Mapping with F71/F41 Teslameters* from the Downloads page at <https://www.lakeshore.com/teslameters>.

3.5.4 Analog Output

The analog output can provide up to ± 14 V however it is recommended that the analog output is operated such that it remains between ± 10 V.

The analog output can provide voltage proportional to:

- The raw (amplified) Hall voltage
- The corrected field reading

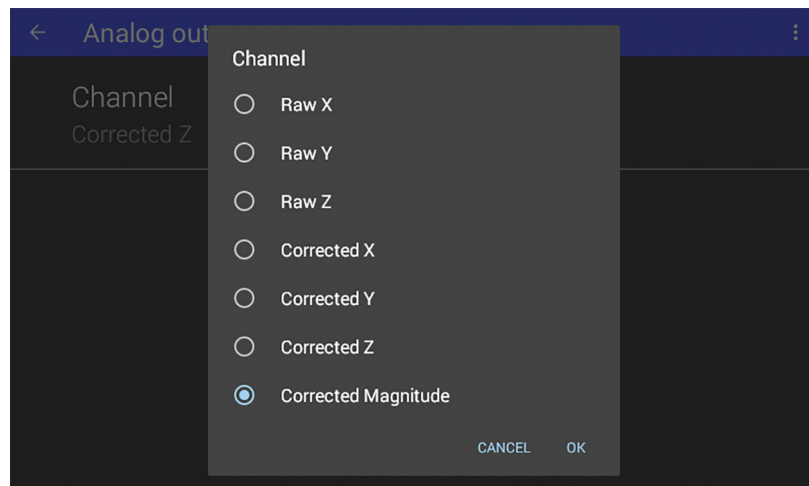

FIGURE 3-20 Analog output



Be sure to connect the analog output to a high impedance input or it may interfere with the sensitive measurement circuitry.

3.5.4.1 Corrected Field Reading

Setting the analog output to "corrected" results in an output voltage that is directly proportional to the front panel field readings.

- When a multi-axis probe is connected, either the X, Y, Z, or vector magnitude field reading can be selected.
- The corrected output voltage updates 2,000 times per second



Corrected input is intended for use in DC mode only. When in AC or high-frequency mode, the output's 2,000 times per second update rate results in voltages that represent the RMS value from the previous 0.5 ms. For alternating fields below 2 kHz, less than a full period will be contained within the window, resulting in fluctuating output voltages.

3.5.4.4.1 Scaling

By default, the corrected analog output is scaled so that 1 V out is proportional to 1 T. Modify this scaling by changing the scaling factor and baseline field of the analog output. The following equation defines the scaling:

$$\text{Corrected analog out voltage} = \text{scale factor} * (\text{field reading} - \text{baseline})$$

For example, to scale ± 10 kG from 0 to 10 V, calculate the scale factor and baseline using this formula:

$$\text{Scale factor} = \frac{10 \text{ V} - 0 \text{ V}}{10,000 \text{ G} - -10,000 \text{ G}} = 0.0005 \frac{\text{V}}{\text{G}}$$

$$\text{Baseline} = -10,000 \text{ G} - \frac{0 \text{ V}}{0.0005 \frac{\text{V}}{\text{G}}} = -10,000 \text{ G}$$

To scale the corrected analog output so that it outputs ± 5 V across a band of interest between 150 mT and 250 mT, use this formula:

$$\text{Scale factor} = \frac{5 \text{ V} - -5 \text{ V}}{0.25 \text{ T} - 0.15 \text{ T}} = 100 \text{ V/T}$$

$$\text{Baseline} = 0.25 \text{ T} - \frac{5 \text{ V}}{100 \frac{\text{V}}{\text{T}}} = 0.2 \text{ T}$$



The analog output is not calibrated. For applications that require high accuracy, correlate the voltage directly to the front panel measurement value.

3.5.4.2 Raw Analog Output

Raw analog output is simply an amplified version of the Hall voltage delivered by the Hall probe. Amplification occurs prior to demodulation or digitization, so it is the most direct representation of the Hall voltage available. These modes are most valuable when viewing high frequency AC signals or magnetic pulses as the signal. Viewing raw analog signals in DC or AC modes will result in a modulated signal that won't be useful.

Due to the raw nature of this signal, the voltage level will not predictably relate to the actual applied field. The best method for calculating the ratio between field and generated output voltage is to measure the voltage directly, and compare it to the peak values that have gone through all the correction required for a more accurate field value.

To help verify whether your calculations are likely to be correct, the following table gives an approximate relationship between voltage and field:

Range	Approximate relationship
35 T	200 mV/T
3.5 T	2 V/T
350 mT	20 mV/mT
35 mT	200 mV/mT

TABLE 3-3 Raw analog output

The approximate relationships in the table are only valid over the flat frequency response bands of both the teslameter and probe. Higher frequencies will appear to have increased gain factors due to higher probe voltages as a result of inductive pickup in the probe.



The inductive properties of the probes have been characterized and are corrected in the teslameter, resulting in accurate reported values to use as a correlation source.

3.5.5 Qualifier

The qualifier indicates whether the field reading is within a threshold set by the user. Optionally, the qualifier can latch when the threshold condition is met.

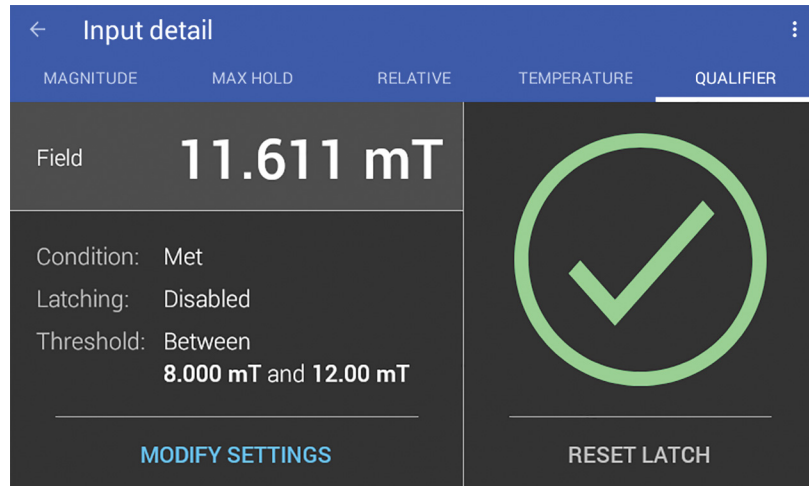

FIGURE 3-21 Qualifier detail with the condition met

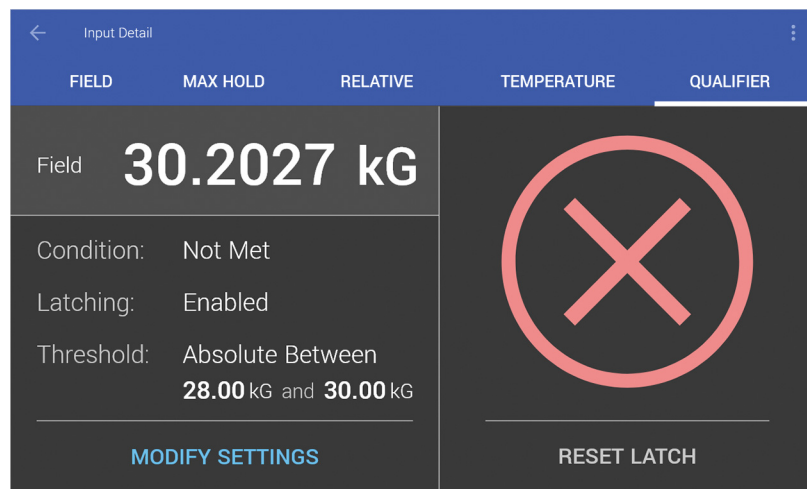

FIGURE 3-22 Qualifier detail with the condition not met

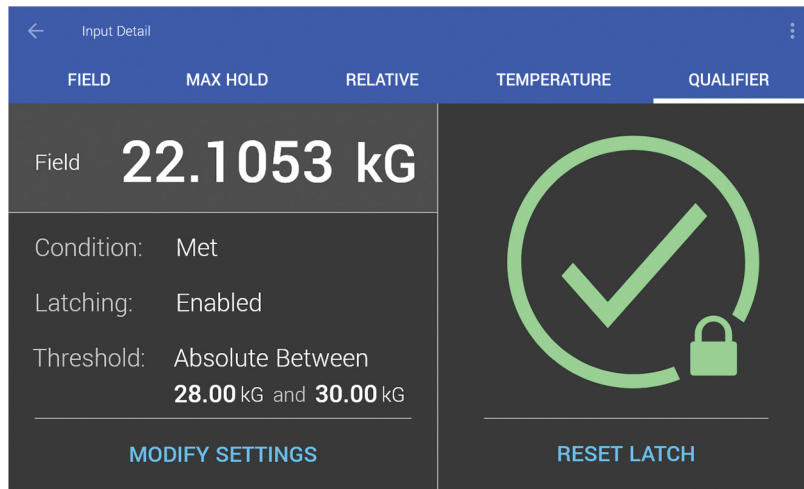

FIGURE 3-23 Qualifier detail with the condition latched

3.5.5.1 Qualifier Threshold Examples

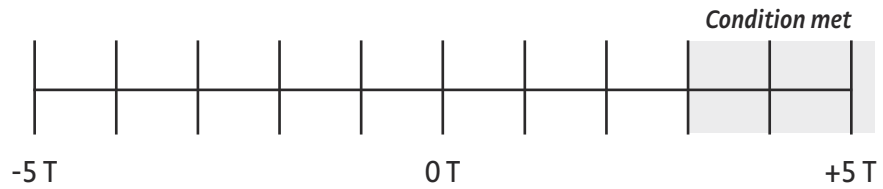

FIGURE 3-24 Over 3 T

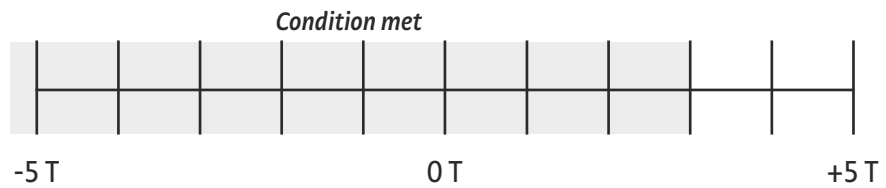

FIGURE 3-25 Under 3 T

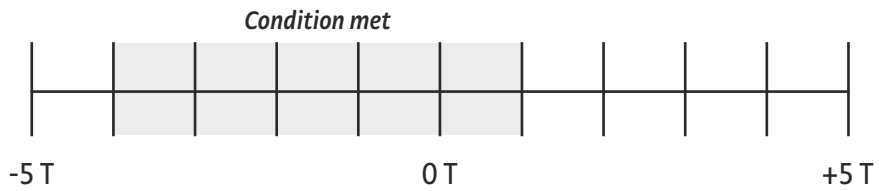

FIGURE 3-26 Between -4 T and 1 T

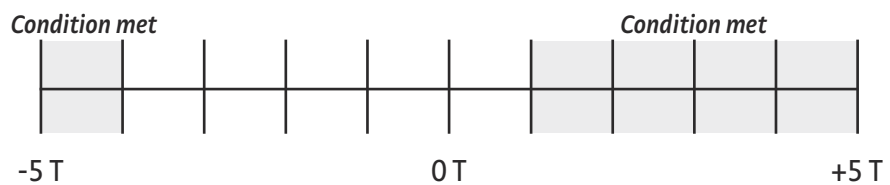

FIGURE 3-27 Outside -4 T and 1 T

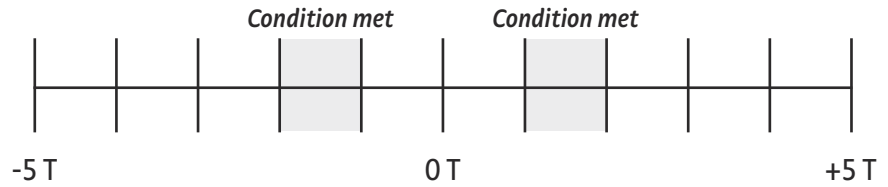

FIGURE 3-28 *Absolute between 1 T and 2 T*

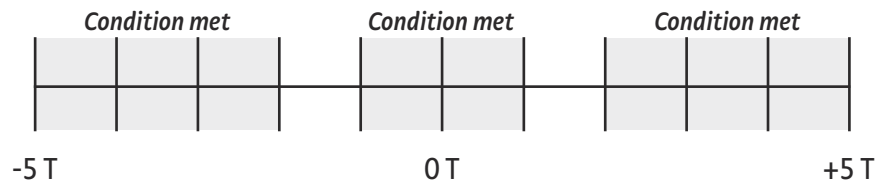

FIGURE 3-29 *Absolute outside 1 T and 2 T*

3.5.6 Digital I/O

The F71/F41 teslameter comes equipped with digital I/O for general purpose input/output (GPIO) use, allowing for integration of hardware control and monitoring. There are two isolated differential inputs, two isolated solid state relay outputs, an isolated +5 V supply, and an isolated ground. The I/O does not reference the main power supply or ground and therefore can directly interface with a wide range of systems.

The pin assignments can be found in the table below. Each input and output can be configured to provide a different function. The available functions are listed in the table below. The digital I/O connections are differential and isolated from the rest of the instrument circuitry. This allows the teslameter to connect to a wide variety of I/O networks without a shared ground.

In addition, isolated +5 V and ground connections are provided on each row of the connector should you wish to use them with the I/O connections. See section 6.7 for pinouts for the digital I/O port

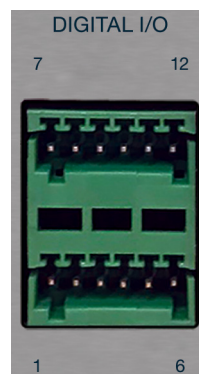

FIGURE 3-30 *Digital I/O port*

3.5.6.1 Digital I/O Connectors

The inputs and outputs are housed on separate connectors. Each teslameter ships with two 6-pin Phoenix Contacts FK-MC 0,5/6-ST-2,5 connectors for use with the digital input and output connections. These connectors use a push-in spring mechanism to capture the wires, so it is recommended that you have access to a flat tip precision screwdriver or similar with a head width of less than 1.5 mm.



FIGURE 3-31 Digital I/O connectors

These connectors accommodate wires with the following characteristics:

Conductor type: solid/stranded

Conductor size: 20 – 26 AWG

Insulator strip length: 8 mm

3.5.6.2 Inputs

Each input can be configured with different functions. The input functions are configured with the `DIGital:INPut#:FUNctIon` command (see section 4.5.2), or through the Digital I/O menu option in the Settings menu. The available functions are:

- *Manual*: the state of the input does not affect the state of the instrument. The state of the inputs is synchronized with the field data, and can be queried through a remote connection.
 Tip: Query the field data and input state at the same time to align field readings with an external action that is tied into one of the teslameter inputs. This is useful for combining collected field data with additional data sources. The easiest way to do this is with the buffered data streaming feature described in section 3.5.3.
- *Max/Min Reset*: On a rising edge, the max and min hold values will be reset to the present field reading. See section 3.4.6 for more information about the max/min hold function.
- *Tare*: On a rising edge, the present field reading is set as the relative baseline value. See section 3.4.7 for more information about relative measurements.
- *Latch reset*: On a rising edge, the latched qualifier state is reset. See section 3.5.5 for more information about the qualifier feature.

The state of the input pins can be read using the `DIGital:IDATa?` query. The returned integer is a bitwise representation of the logic level presented at the respective inputs (i.e., bit 0 = state of input 1, bit 1 = state of input 2).

Interface Commands: `DIGital:INPut#:FUNction`, `DIGital:IDATA?`

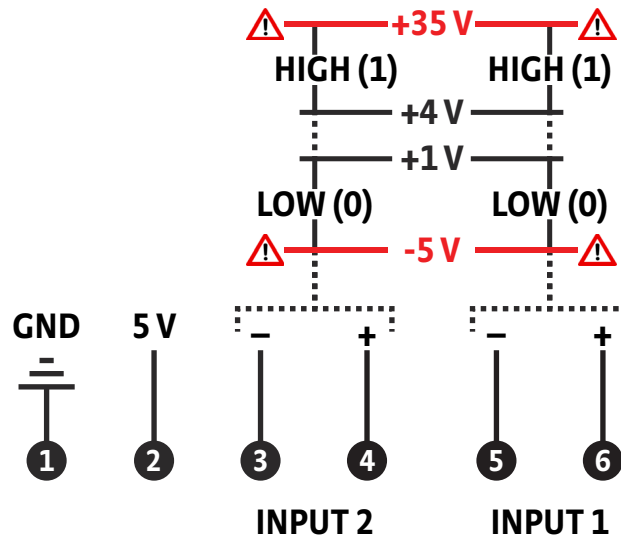

FIGURE 3-32 Input diagram

The input states are sampled every 10 ms in sync with the field reading minimum averaging window. The sampling occurs during the middle of the reading (5 ms offset). Querying the input states always returns the most recent value.

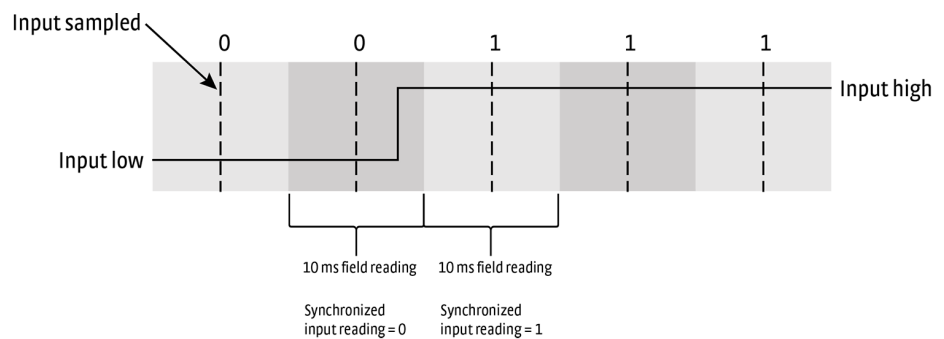

FIGURE 3-33 Input sync diagram

3.5.6.3 Outputs

The `DIGital:OUTput#:FUNction` command is used to configure a specific output relay or through the Digital I/O menu option in the Settings menu. The `DIGital:OSETting` command is used to configure the state of an output pin that is configured for manual mode.

- **Manual:** the state of the output relay is determined by the user's settings. These settings can be changed through the front panel or the remote interface.
- **Field control ramping:** the output relay is closed while field control is ramping. Field control is an optional feature. See section 3.5.2 for more information about the field control option.
- **Qualifier:** the output relay is closed when the qualifier condition is met. See section 3.5.5 for more information about the qualifier feature.

Interface Commands: `DIGital:OUTput#:FUNction`, `DIGital:OSETting`

3.5.7 Temperature Compensation

All standard Hall probes have a built in temperature sensor located near the Hall sensor. This sensor allows for automatic temperature compensation over the standard operating range. Temperature compensation can be disabled in the Temperature tab of the Measurement Setup screen.

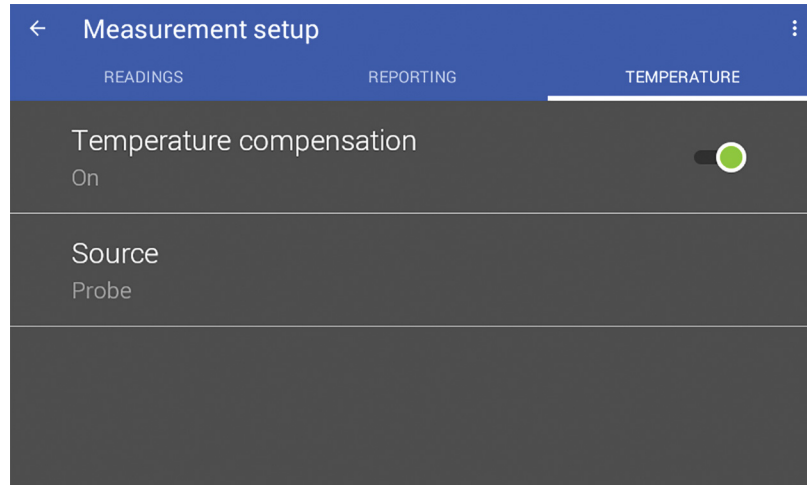

FIGURE 3-34 Temperature compensation

Manual temperature compensation is available when using non-standard probes that do not contain a temperature sensor or when operating at a temperature beyond the range of the temperature sensor. In the Temperature tab, change the compensation Source from Temperature Sensor to Manual. This will reveal the Compensation setting which must be set to the temperature at which the Hall probe sensor is operating. The manual compensation temperature can be set via the front panel or through serial commands, for example: `SENSe:TCOMpensation:MTEMperature`

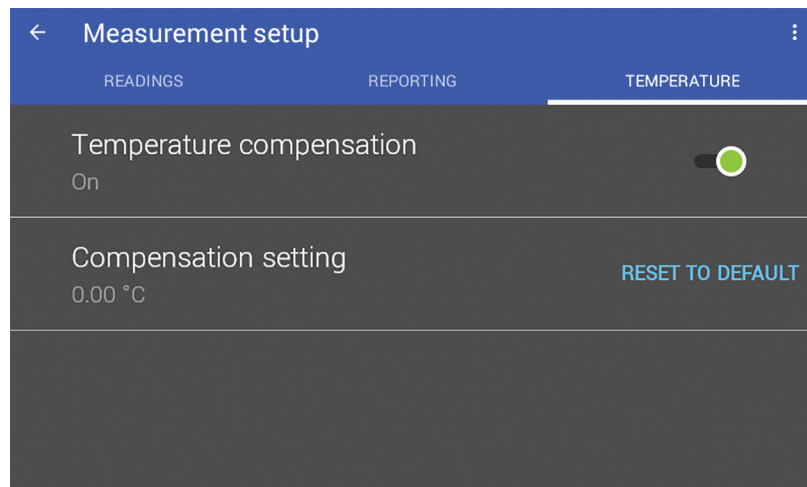

FIGURE 3-35 Manual temperature compensation

3.5.8 Cryogenic Operation

The Hall sensor excitation current causes some self-heating of the sensor. This self-heating can prevent cryogenic systems from achieving very cold temperatures when measuring field. The cryogenic operation setting solves this problem by reducing the amount of excitation current flowing through the sensor. When cryogenic operation is active, the self-heating of the sensor is reduced by a factor of 100. The drawback of cryogenic operation is increased noise and reduced accuracy.



The most sensitive field range is not available when using cryogenic excitation due to the reduction in signal strength.

A snowflake icon appears at the top right of the screen during cryogenic operation. The feature can be disabled on the Measurement Setup screen.

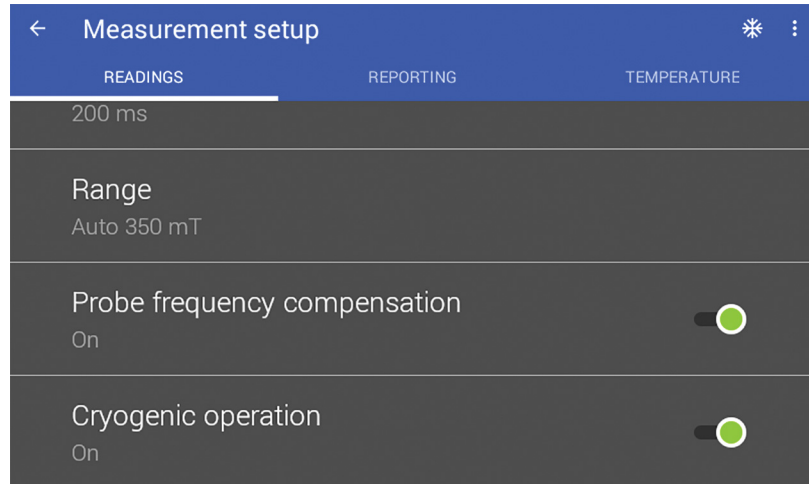

FIGURE 3-36 Cryogenic operation

The sensitivity of the sensor changes slightly with temperature. Use manual temperature compensation (section 3.5.7) when operating in a cryogenic environment.

3.5.8.1 Temperature Measurement

The temperature compensation detail screen displays the current temperature reading for the probe tip temperature sensor. Temperature compensation is on by default but can be turned off for troubleshooting, or set to manual to allow temperature inputs that are outside the standard operating range of the probe temperature sensor (0° to 90° C).

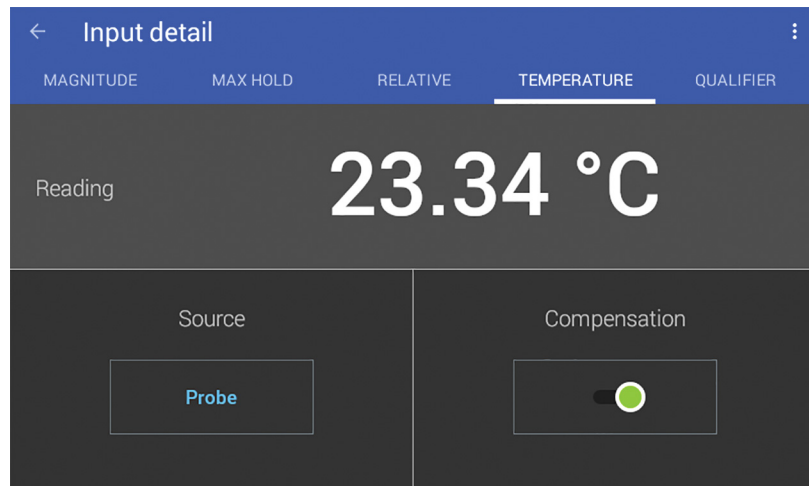

FIGURE 3-37 Temperature measurement

Cryogenic probe lifetimes will be extended if the following precautions can be taken:

- Lower the sensor temperature at a ramp rate of < 1 K/second when possible. Thermal shock from liquid cryogen submersion may lower the product lifetime.
- When warming the probe tip to room temperature, allow the tip to come to room temperature and dry before returning the probe tip to cryogenic temperatures.

3.5.9 Probe High-Frequency Operation

When measuring AC fields with frequencies greater than a few thousand hertz, small loop areas in the probe will generate inductive voltage much like a coil. As the frequency of the field increases so does the inductive voltage. The F71/F41 teslameter compensates for the induced voltages by default using a digital low-pass filter. This feature is enabled by default whenever a probe is connected. It can be disabled on the Measurement Setup screen.

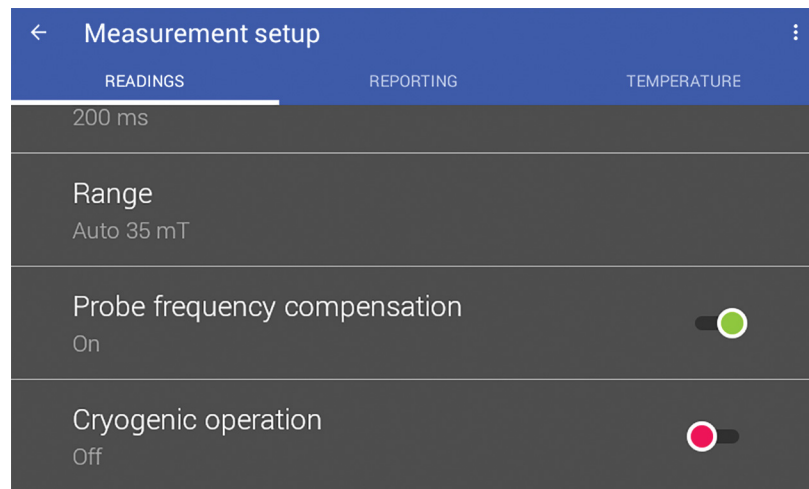

FIGURE 3-38 Probe frequency compensation

3.5.10 Field Units

Use the Field units setting to change readings from Tesla to Gauss.



Field units are not editable for teslameters sold in Japan. Tesla is the only option available.

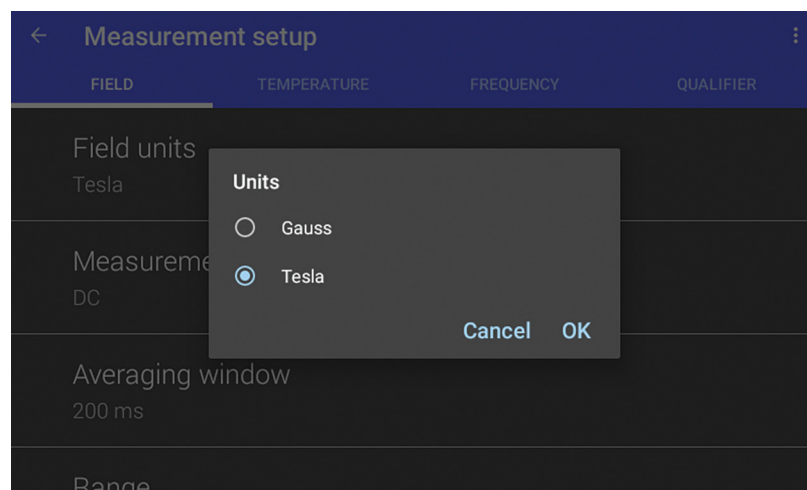

FIGURE 3-39 Field units

3.5.11 Configurable Filters

The teslameter can apply fully configurable digital filters to the RMS reading when in high frequency mode. Three filter types are available:

- Low pass, which emulates two low pass RC filters cascaded together. The low pass filter cutoff frequency (-3 dB frequency) is configurable between 1 Hz and 90 kHz.
- High pass, which emulates two high pass RC filters cascaded together. The high pass filter cutoff frequency (-3 dB frequency) is configurable between 1 Hz and 90 kHz.
- Band pass, which emulates two low pass and two high pass RC filters cascaded together with a correction to ensure the center frequency has a gain of 1. The center frequency is configurable between 1 Hz and 90 kHz. The Q factor of the bandpass filter is about 0.776.

Example filter responses:

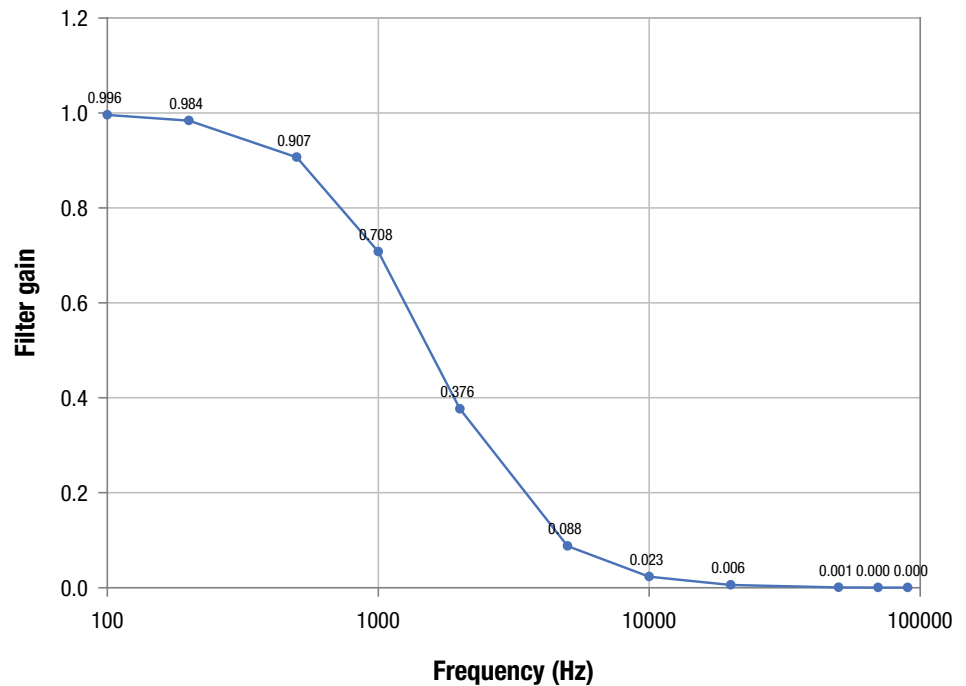

FIGURE 3-40 Low pass filter response with a 1 kHz cutoff

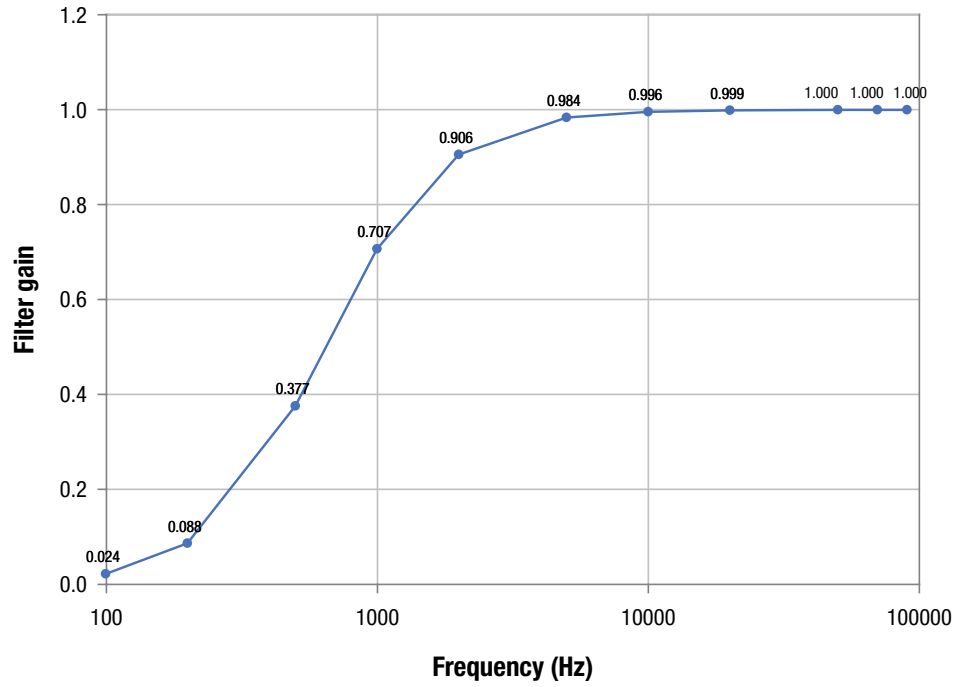

FIGURE 3-41 High pass filter response with a 1 kHz cutoff

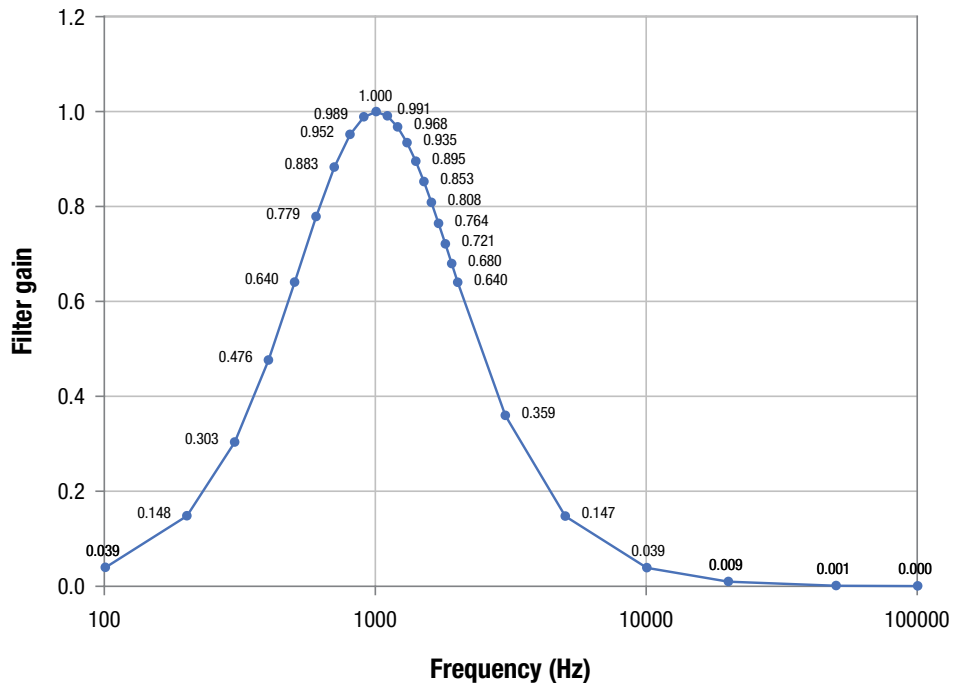

FIGURE 3-42 Band pass filter response with a 1 kHz center frequency

3.5.12 System Settings

The System settings menu is provided to view and set/reset general instrument settings, update firmware, and view legal information. To find these settings, tap the Settings menu (top left corner of the screen) to go to the navigation drawer, then tap System settings.

3.5.12.1 About

The following fields are displayed on the About tab:

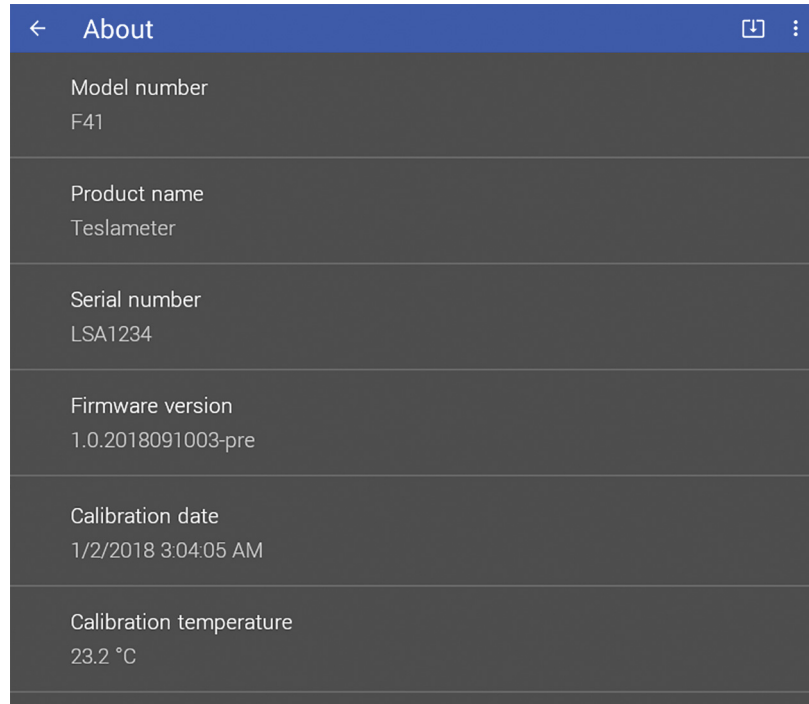

FIGURE 3-43 System settings: About tab

Field	Description
Model number	This field displays the model number.
Product name	This field will always display Teslameter.
Serial number	The unique identifier for this specific teslameter, assigned during manufacturing.
Firmware version	The semantic version number assigned to the Lake Shore Firmware (LSFW) package presently running.
Calibration date	The date and time the teslameter was last calibrated successfully at Lake Shore.
Calibration temperature	The ambient temperature experienced by the teslameter at the time of calibration. This temperature is relevant when considering the 1 year DC accuracy specifications for the teslameter.

TABLE 3-5 About fields

3.5.12.2 Connectivity

The following fields are displayed on the Connectivity tab. Touch the enable switch next to each option to change settings:

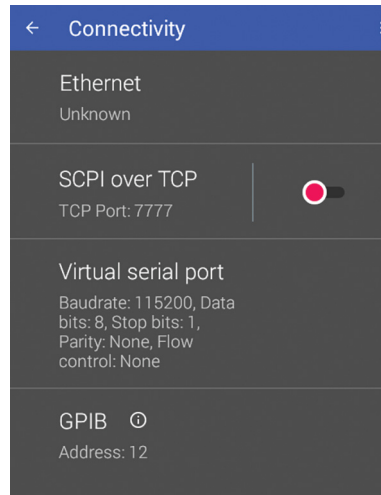

FIGURE 3-44 System settings: Connectivity tab

Field	Description
Ethernet	Touch the Ethernet box to see IP settings.
SCPI over TCP	Determines whether the teslameter will respond to SCPI commands from the Ethernet connection. If this option is turned off, the instrument will only respond to SCPI commands over the USB connection. This feature must be turned on if the GPIB adapter is connected to the teslameter.
Virtual serial port	Enables serial communications via USB.
GPIB	Allows setting the GPIB address if the MR-GPIB-USB adapter is attached. For more information, see: https://www.lakeshore.com/products/product-detail/measureready/gpib-adapter/ .

TABLE 3-6 Connectivity fields

3.5.12.3 Display and Sound

The front panel display brightness can be adjusted for optimal viewing. The default value should work well in most standard environments, but deviations in room temperature and extreme viewing angles can cause the display brightness to require adjustment for optimal viewing.

As with many touchscreen LED backlit displays, keeping the brightness to a minimum will help to maximize the life of the display. The half-life of the display is rated with a typical value of 30,000 hours. In addition, to help further maximize the life of the display, the teslameter implements an auto dimming function when the display has not been touched for a prolonged period of time.

The teslameter will produce sounds on various presses of the screen as a means to provide feedback to the user that a key press has occurred. The volume setting can be set to 100%, 75%, 50%, 25%, or off.

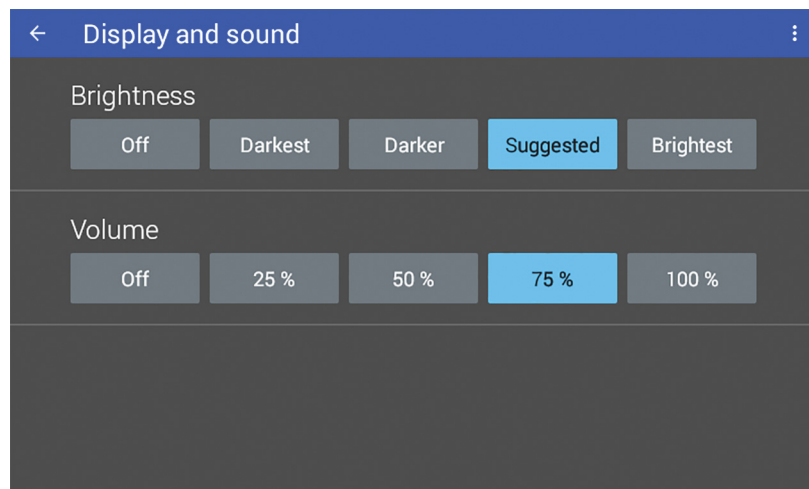

FIGURE 3-45 *Display and sound*

3.5.12.4 Legal

This screen is available for the user to see the various open source software used.

3.5.12.5 Update

See section 3.5.14 for information on firmware updates.

3.5.12.6 Privacy

If enabled and an internet connection is present, the instrument will periodically send usage statistics and crash reports to identify problems that could be addressed. No personally identifiable information or measurement data will be collected or sent with this service.

3.5.12.7 Date and Time

The teslameter contains a real-time clock, allowing the current date, time, and time zone to be stored. The time, date and time zone can be set and viewed via the front panel or over the remote interface.

In addition, the teslameter has a feature to automatically set its date and time. This requires an active internet connection to maintain the instrument time accurately.

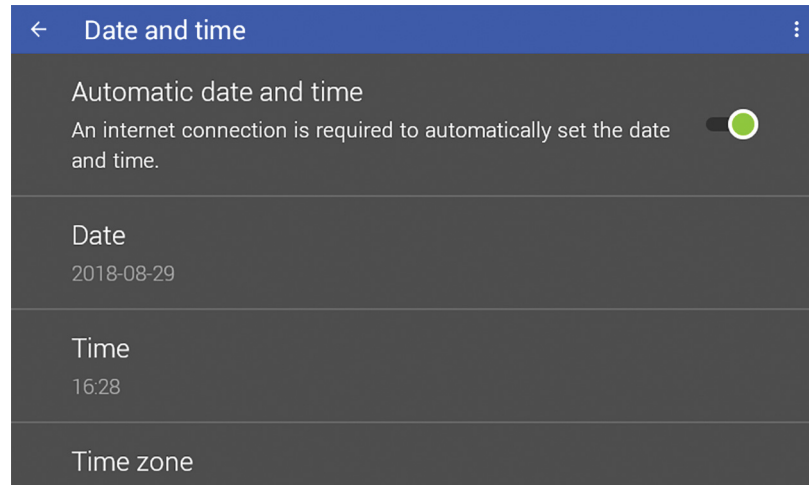

FIGURE 3-46 *Date and time*

3.5.13 Reset

The teslameter has two types of settings: instrumentation and system. Instrumentation settings includes settings that are unique to the instrument, such as acquisition mode, autoranging, and field units. System settings are settings common to most instruments, such as volume, brightness and TCP/IP settings.

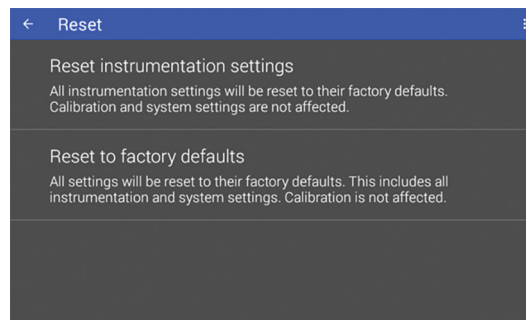

FIGURE 3-47 *Reset*

3.5.13.1 Reset instrumentation settings

Instrumentation settings are not stored in non-volatile memory. Therefore, the table below can be considered a listing of both the power-on and the default settings. This will not affect calibration.

Setting	Default – first power up/ factory reset	Default – powered on/ restarted	Default – probe connected
Acquisition mode	DC	Last state	Revalidated
Averaging window	200 ms	Last state	Unchanged
Relative offset	0	Last state	Unchanged
Autoranging	Off	Off	On
Analog output	Corrected magnitude reading	Last state	Unchanged
Field units	Tesla	Last state	Unchanged

TABLE 3-7 Default settings

Interface Commands:

SYSTEM: PRESET or ***RST**

3.5.13.2 Reset to factory defaults

If necessary, the instrument settings can be restored to factory defaults. System settings are stored in non-volatile memory. A factory default reset will reset both instrumentation settings and system settings. As with the reset instrumentation settings function, a factory default will not affect calibration.

When a factory reset is initiated, diagnostic logs and user added firmware repositories are cleared (the default firmware.lakeshore.com/production remains). In addition, the following system settings are reset back to their default state:

Connectivity – general	Default	Display and sound	Default
SCPI over TCP	Disabled	Brightness	50
TCP socket port number	7777	Volume	50
Connectivity – Ethernet	Default	Date and time	Default
IP Configuration	DHCP	Automatic date and time	Disabled
Static IP	192.168.0.12	Time zone	GMT
Static Gateway	192.168.0.1	Privacy	Default
Static Subnet mask	255.255.255.0	Send usage statistics	Disabled
DNS 1	8.8.8.8	Keypad	Default
DNS 2	8.8.4.4	Lock	Disabled
Connectivity – GPIB	Default		
Address	12		

TABLE 3-8 Reset to factory defaults values

Interface Commands:

SYSTEM: FACTORYRESET

3.5.14 Firmware Updates

3.5.14.1 Overview

The F71/F41 teslameter can update its firmware manually by attaching a USB Type-C™ drive to the rear panel. However, the easiest method is to connect the instrument to the internet via Ethernet, and update directly from the Lake Shore firmware server.

Firmware comprises many files, aggregated together to form a Lake Shore Firmware (LSFW) package. The teslameter stores versions of its LSFw packages in its internal memory. This local memory location is called the “local repository”. This allows you to downgrade firmware should you choose, since older versions will still remain on the teslameter in the local repository. In addition, Lake Shore maintains LSFw packages on a network server that allows us to deploy those packages to all teslameter customers. This is called the “remote repository”.

Lake Shore recommends enabling the “Notify when updates are available” setting to ensure your teslameter firmware is up-to-date with the latest features and updates. If used with a valid network connection, the teslameter will display a notification on the notification bar as soon as an update is available, but will not apply the update until instructed.

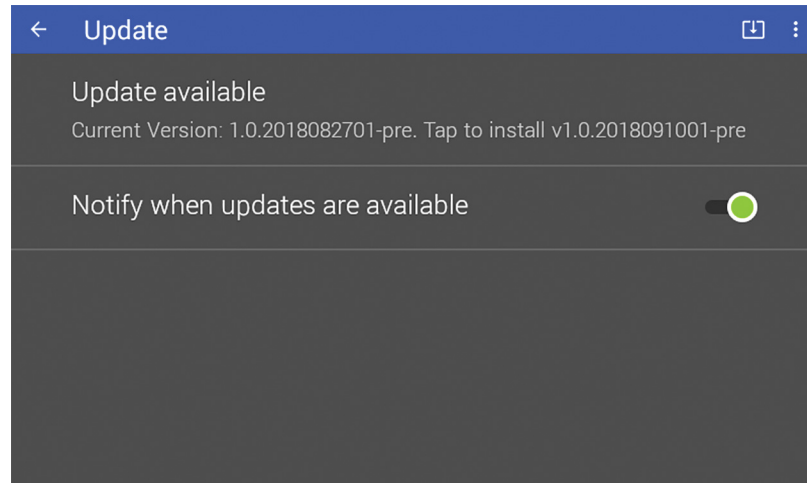

FIGURE 3-48 Firmware updates: notification

If the teslameter notifies you that a firmware update is available, tap “Update available”. A pop-up notification will appear, prompting you to install. Click Install and follow any on-screen instructions.

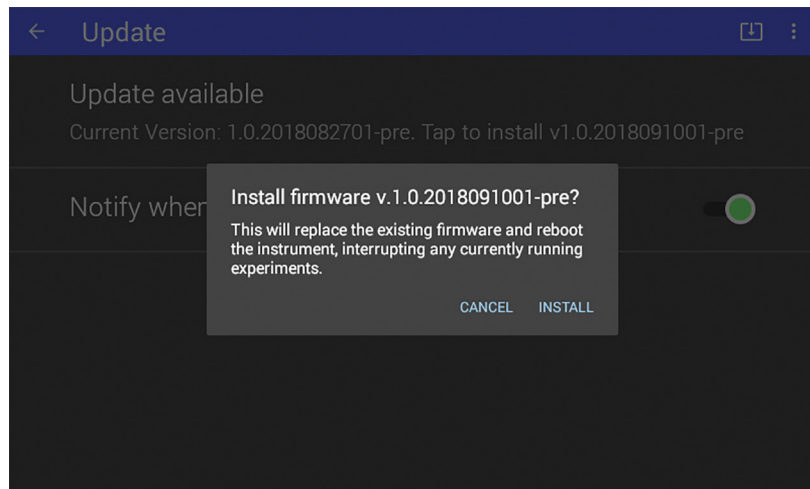

FIGURE 3-49 Firmware updates

3.5.14.2 Manual Update Procedure Using USB Type-C™

The firmware can be downloaded from the Lake Shore website and manually installed on the teslameter using a USB Type-C™ drive:

1. Go to the Downloads page at <https://www.lakeshore.com/teslameters> to download the firmware.
2. Enter your name and e-mail address so that we can keep you updated on any new firmware for your instrument.
3. Insert the USB drive into your computer and copy the downloaded teslameter LSFW package to the root directory of the USB drive.
4. Remove the drive from the computer and insert it into the USB Type-C™ port of the teslameter.
5. On the teslameter front panel, tap the Settings menu (top left corner of the screen) to go to the navigation drawer. Then tap System settings. Touch Update.
6. Click “Updates are available. Click here to install” and follow the on-screen instructions to update the firmware.

3.5.15 Live Plotting

Live plotting shows DC field measurements versus time for each axis and the magnitude field. The live plot will collect a fixed number of points at a rate determined by the averaging window setting.

To access the live plot screen, tap the readings shown on the input detail screen, as shown in the image below:

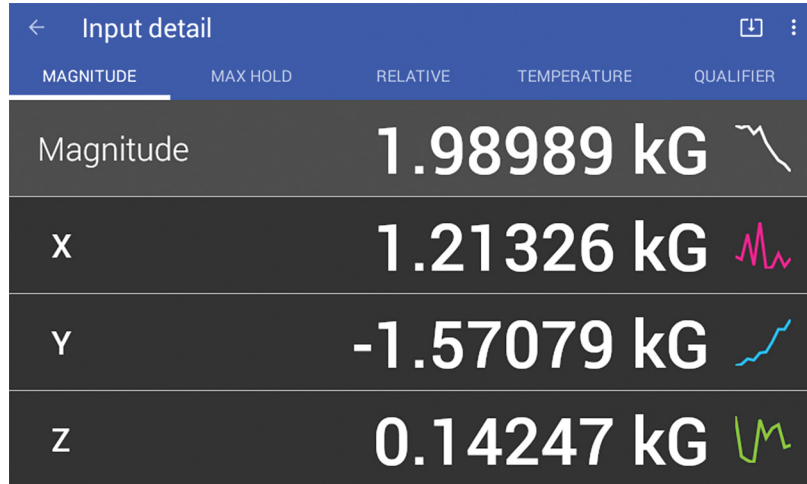

FIGURE 3-50 Input detail screen with a 3-axis probe

The plot may be rescaled using touch screen gestures such as swiping to move and pinching to zoom in and out. The plot scaling may be reset using the **RESET ZOOM** button. The data on the plot may be exported to a connected flash drive as a CSV file using the **EXPORT** button.

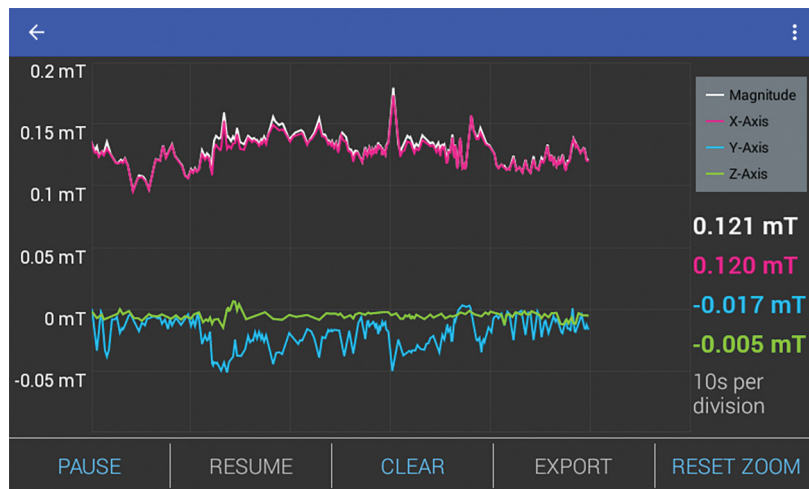

FIGURE 3-51 Live plot with a 3-axis probe

3.6 Probes

3.6.1 General Probe Information

Full details on FP Series probes are provided on our website. Please see: <https://www.lakeshore.com/products/categories/overview/magnetic-products/hall-probes/fp-series-hall-probes>.

FP Series probes make use of Hall sensors to characterize magnetic fields. A Hall sensor is a solid state device that provides an output voltage proportional to magnetic flux density. As implied by its name, this device relies on the Hall effect.

The Hall effect is the development of a voltage across a sheet of conductor when current is flowing and the conductor is placed in a magnetic field. Electrons (the majority carrier most often used in practice) “drift” in the conductor when under the influence of an external driving electric field. When exposed to a magnetic field, these moving charged particles experience a force perpendicular to both the velocity and magnetic field vectors. This force causes the charging of the edges of the conductor, one side positive with respect to the other. This edge charging sets up an electric field which exerts a force on the moving electrons equal and opposite to that caused by the magnetic-field-related Lorentz force. The voltage potential across the width of the conductor is called the Hall voltage.

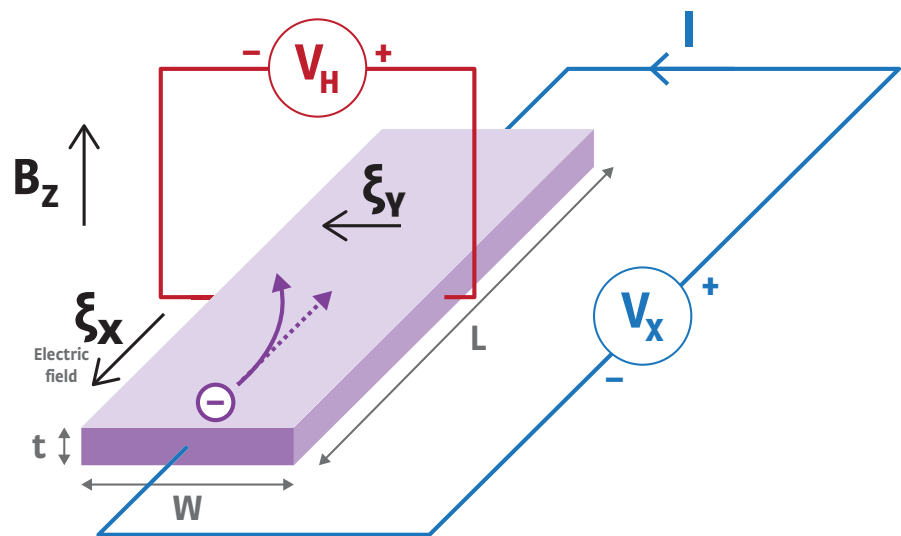

FIGURE 3-52 Hall voltage

The generated Hall voltage for a given field will vary with temperature. Each standard Hall probe contains a temperature sensor at the tip, allowing the detection of sensor temperature, and applying temperature compensation around room temperature. Cryogenic probes do not measure temperature and should be compensated manually.

3.6.2 Probe Types

3.6.2.1 Sensors

InAs Hall sensors are currently the only sensor types available with FP Series probes. InAs Hall sensors offer a great balance of sensitivity, linearity, stability and ruggedness. These sensors set the new standard for the majority of field measurement applications.

3.6.2.2 Orientation

Hall sensors are inherently directional, so the probe should be aligned so that the sensor is perpendicular to the field direction, maximizing measured field.

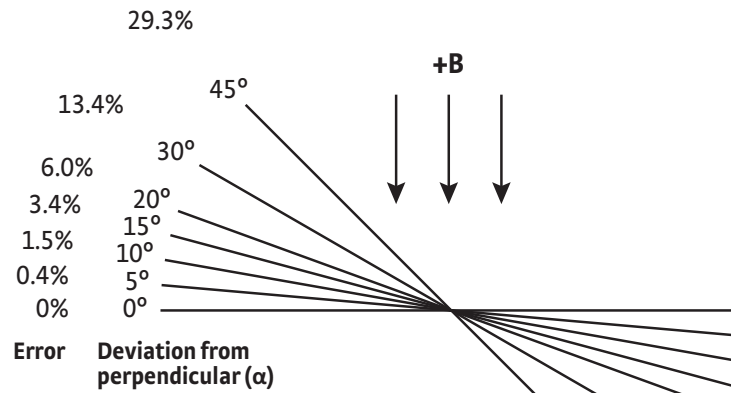

Effect of angular variations on percentage of reading error where percent error = $(1 - \cos \alpha) 100$

FIGURE 3-53 Sensor orientation

3.6.2.2.1 Transverse

The sensor is positioned to measure fields running perpendicularly through the probe stem. This is most useful for measuring fields inside magnet gaps. These probes are easily identified by their flattened rectangular stem.

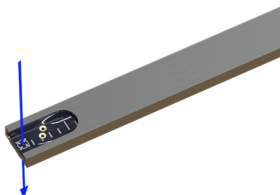

FIGURE 3-54 Transverse orientation

3.6.2.2.2 Axial

The sensor is placed very near to the tip of the probe and aligned to measure fields normal to the tip of the probe. This orientation is helpful when measuring inside solenoids, and can be useful for measuring fields at magnet poles.



FIGURE 3-55 Axial orientation

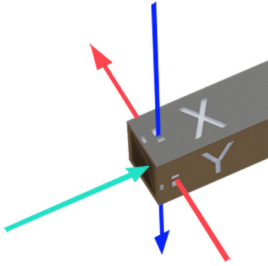

FIGURE 3-56
3-Axis orientation

3.6.2.2.3 3-Axis

Multiple sensors are placed to measure three orthogonal field vectors, allowing the measurement of both the overall field value and direction. This is particularly useful in several scenarios:

- Complex fields where the field direction is not known or changing over time
- Quick handheld measurements
- Field mapping of a volume

3.6.2.3 Stem Type

Each sensor can be housed in various stem types suited for different applications.

3.6.2.3.1 Standard

The general-purpose stem options offer an excellent balance of size and strength. Constructed from extruded and precision machined aluminum, these stems are the superior choice in most situations.

! CAUTION

The sensor assembly is robust and able to survive impacts, but the rest of the aluminum stem is hollow and may suffer slight deformation, particularly with longer stems. If this occurs, it may be possible to apply gentle pressure to return the stem to its original shape. Use caution; a snapped stem is not covered by the warranty.

3.6.2.3.2 Cryogenic

Used for ultra-low temperature applications:

- Non-magnetic stainless-steel alloy minimizes heat leak, while providing strength
- Greater stem lengths offered as standard to reach into the cryogenic environment
- Vented at the tip to allow cryogenics to escape safely
- Cryogenic InAs Hall sensors used in place of standard sensors

|| NOTE

These probes do not contain an integrated temperature sensor. Temperature compensation may be achieved by setting the temperature using an external source. See section 3.5.8.

3.6.2.4 Stem Length

Stem length is defined as the distance from the end of the handle or mounting fixture to the tip of the probe. Please be aware that stem deflection can occur on longer stems when aligned horizontally.

3.6.2.5 Form Factor

3.6.2.5.1 Handheld



FIGURE 3-57 Handheld

The default handle configuration is a handheld probe with an anodized aluminum grip for a solid and long-lasting grip surface. Labels at the end of the handle serve as a way to identify polarity and handle orientation.

3.6.2.5.2 Mountable

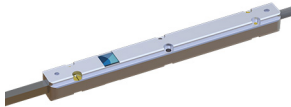

FIGURE 3-58 Mountable

The mountable form factor features a flat machined aluminum surface for use in situations where probe mounting is required for repeatable measurements. It also includes locating pinholes for precise probe alignment, and is held in place with two screws. Drawings and CAD models for this form factor may be downloaded from the Lake Shore website:

<https://www.lakeshore.com/products/Hall-Probes/fp-series/pages/Downloads.aspx>

3.6.2.6 Cable and Connector

The probe cable is light and flexible, but maintains signal integrity. This insulation is susceptible to wrinkling if bent excessively.



To avoid damage, do not bend the cable beyond its rated maximum bend radius of 3 cm for single-axis probes, and 4 cm for multi-axis probes.

A single connector has been selected to serve both single and multi-axis probes. This connector also includes an EEPROM that contains probe calibration data, allowing the probe to be recognized by the teslameter after being connected.

3.6.3 Installation

3.6.3.1 Packaging

Retain any shipping carton(s) in which equipment is originally received, in the event that any equipment needs to be returned to Lake Shore for periodic recalibration. Probes damaged due to insufficient packaging during return shipping are not covered by the warranty. Probes are shipped in one of the following ways, depending on size.

3.6.3.1.1 Standard Packaging

Standard packaging is a cardboard box that uses a foam layer to separate the probe from the cable, with the probe being secured with a cut-out. This box is suitable for probe storage when not in use.

3.6.3.1.2 Wooden Crate

Probes with a stem longer than 30 cm are shipped in a wooden crate for strength. A Phillips head screwdriver or power drill is required to remove the screws securing the lid of the crate. The primary purpose of the crate is to safely deliver the probe to its destination, however, it may also be used for probe storage. If this is the case, it is recommended that the crate be sanded thoroughly to reduce the risk of splinters.

3.6.3.2 Mounting

3.6.3.2.1 Locating Pins

For best results when mounting a mountable probe, it is recommended that locating pins be used to allow the probe to be reliably and consistently attached. This is particularly important if the probe is to be periodically returned to Lake Shore for recalibration. The locating pins allow the probe to return to the same position and orientation every time. The pin recesses in the probe are designed for 2 mm diameter pins no higher than 1.5 mm.

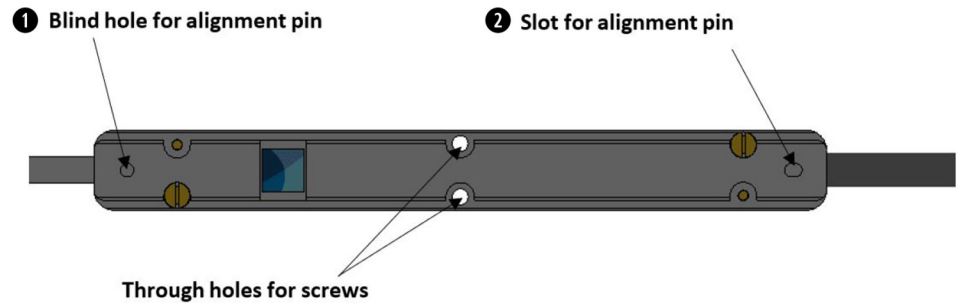

FIGURE 3-59 Locating pins

Pin	Description
1	The pin recess positioned closest to the stem of the probe is the primary locating feature, used as the point of reference for the probe sensing element.
2	The remaining pin recess is positioned 100 mm from the first pin and is used to stop the probe rotating around the first pin. This recess is elongated to make it easier to seat if the distance between the pins is not exact.

TABLE 3-9 Locating pins

3.6.3.2.2 Fasteners

Holes have been provided on the probe to secure the probe with fasteners once it is seated over the locating pins. These fastener through holes are not intended as locating features for the probe. However, if precision and repeatability of the sensing element location are not required, the holes can be used in lieu of the locating pins. These through holes are sized for M2 fasteners with socket heads. Fasteners with larger heads may not fit into the recess provided for the screw head. Ensure screws have heads less than 4 mm in diameter and sit flat against the probe surface, i.e., are not counter-sunk.

3.6.3.2.3 Probe Orientation

Mountable probes have the Lake Shore logo on just one side of the probe, making it easier to repeatedly mount the probe in the same orientation and ensure the polarity and/or sensor location is not accidentally swapped.

3.6.3.3 Connection

All probes have the same connector and spring-loaded latching mechanism to make connections to the teslameter easier. When making a connection, the following points should be considered:

- The connector is not rotationally-symmetrical, please ensure that the largest side of the connector is facing upwards.

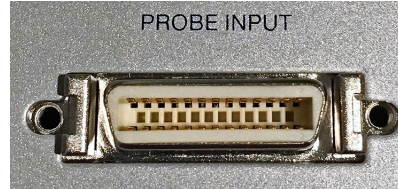

FIGURE 3-60 Probe input connector

- The connector is fully attached when the latching mechanisms on both sides of the connector click into place.
- In some situations during connection, EEPROM communication can be interrupted due to a brief break in the electrical connection. This will result in a probe read error. Unplug the probe from the teslameter and try the connection again. If the problem persists, please contact Lake Shore Service. As soon as the probe successfully connects, field values will be displayed on the screen.
- Remove the connector by squeezing both sides of the connector to release the latching mechanism.
- Probes are hot-swappable (probes can be changed while the teslameter is powered on).

Once connected, probe information can be viewed on the teslameter. See section 3.5.1 for more information.

3.6.3.4 Operating Environment

3.6.3.4.1 Temperature

The probe handle and cable can withstand operating and storage temperatures up to 80 °C, and the stem can withstand temperatures to 90 °C.

3.6.4 Operation

3.6.4.1 Active Area Location

Where possible, active area locations are made visible on the probe, except for cryogenic and axial probes (see section 3.6.4.1.3). Note that some probes have active areas that are not centered on the stem axis, meaning that beyond switching polarity, the magnitude of the field will change if the stem is rotated in a fixed magnetic field. The side of the stem closest to the stem surface, resulting the largest field reading possible, is referred to as the “hot” side; the reverse side is referred to as the “cold” side. This concept is most important when working with transverse probes, though this should also be considered with 3-axis probes. For more information, please see <https://www.lakeshore.com/fp-probe-specs>.

3.6.4.1.1 Transverse Standard (TS)

The active area on each of these probes is centered on the axis of the stem, but is not visible. For more information, please see <https://www.lakeshore.com/fp-probe-specs>.

3.6.4.1.2 3-Axis Standard (ZS)

The three individual sensors don't occupy the same point in the probe, so the three separate measurements are for slightly different positions in space. This results in the specification of an active volume, as opposed to an active area for single-axis probe variants. Orthographic views of the sensor active areas are laser etched onto the aluminum stem. There is no indication of active areas on the tip of the probe (Z-axis).

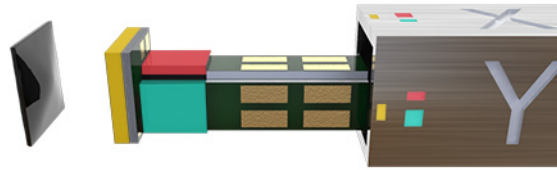

FIGURE 3-61
3-Axis standard (ZS) probe

3.6.4.1.3 Transverse Cryogenic (TC)/Axial Standard (AS)/Axial Cryogenic (AC)

The active area on each of these probes is centered on the axis of the stem, but is not visible. For more information, please see <https://www.lakeshore.com/fp-probe-specs>.

3.6.4.2 Polarity

Given that Hall sensors are directional, the orientation of the probe will determine whether readings are positive or negative.

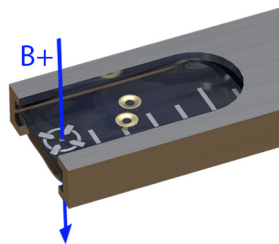

FIGURE 3-62
Transverse polarity

3.6.4.2.1 Transverse

Polarity can easily be confused on transverse probes as twisting the probe 180° will result in a reversed polarity. When looking at the tip of a transverse probe, a positive field value will be reported when the magnetic field is orientated as shown below.



FIGURE 3-63 Handheld probe

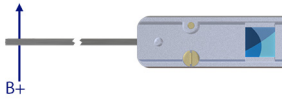
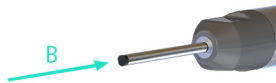
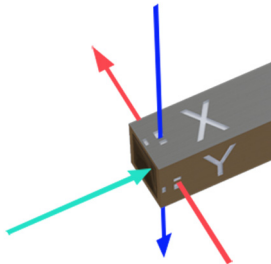

FIGURE 3-64 Mountable probe

FIGURE 3-65
Axial polarityFIGURE 3-66
3-Axis polarity

When placed in magnet gaps, the tip of the probe may not always be visible. In this situation, the handle of both the handheld and mountable probes are marked to indicate polarity:

- **Handheld:** one side of the handle has a field indicator badge showing that a positive field reading will result when the field direction is in the handle through the badge.
- **Mountable:** the Lake Shore logo is present on only one of the mounting surfaces. When the logo is facing up, a positive field reading will result when the magnetic field is passing left-to-right through the sensor.

3.6.4.2.2 Axial

A positive field value will be reported when the magnetic field direction is in the stem toward the handle or mounting block.

3.6.4.2.3 3-Axis

With three different axes, identifying field direction and polarity is much more difficult than single-axis probes. In this situation, the handle will be less useful than looking directly at the stem tip where active area location and axis labels are laser engraved.

- **X-axis:** positive field reading when field passes through the probe from the side marked with X to the side without an X.
- **Y-axis:** positive field reading when field passes through the probe from the side marked with Y to the side without a Y.
- **Z-axis:** positive field reading when field is directed into the probe stem.

Chapter 4: Computer Interface Operation

4.1 General

This chapter provides operational instructions for the remote interface for the Lake Shore F71/F41 teslameter. The teslameter supports the following remote interfaces for direct user control:

- USB (emulating a serial communications port)
- Ethernet
- GPIB



Lake Shore teslameters sold prior to August 2020 also included Wi-Fi capability. Please see: <https://www.lakeshore.com/instruments-wi-fi-addendum.pdf>.

The F71/F41 teslameter adheres to the Standard Commands for Programmable Instruments (SCPI) standard, regardless of the remote interface selected for user control.

4.2 Standard Commands for Programmable Instruments (SCPI)

The F71/F41 teslameter adheres to the SCPI command language. SCPI is a standardized command language, presently maintained by the Interchangeable Virtual Instruments (IVI) Foundation, used for controlling test and measurement instruments. SCPI provides instrument control with a standardized command syntax and style.

The following sections provide a brief overview of the SCPI language, syntax, and behavior, that will allow a new instrument user to get up and running quickly. The complete SCPI specification can be found on the IVI website: <http://www.ivifoundation.org/docs/scpi-99.pdf>.

4.2.1 Command Types

There are two different types of SCPI commands that the teslameter responds to: common and subsystem.

4.2.1.1 Common

SCPI builds upon the IEEE 488.2 standard. Because of this, several of the commands found in IEEE 488.2 are required by the teslameter to be considered SCPI compliant. These commands include, but are not limited to, functionality to reset (*RST), clear the status registers (*CLS), or identify the instrument (*IDN?).

These commands are identifiable by the fact that they:

1. Always consist of three letters and
2. Are always preceded by an asterisk

4.2.1.2 Subsystem

In addition to the common commands, SCPI defines subsystem commands. If the teslameter is considered a “system”, then the logical grouping of its various functions can be considered different “subsystems”, forming a hierarchical “tree”. Each subsystem is comprised of program headers. Together, these comprise the individual SCPI command. The following is an example of several SCPI commands and how they fit into the hierarchical tree:

```

FETCh
  [:FIEld]
    :DC? <[MAGNitude] | X | Y | Z | ALL>
SENSe
  [:FIEld]
    :MODE?
    :MODE <DC | AC | HIFRequency>
    :RANGe <field value>
    :AUTO?
    :AUTO <Boolean>
SOURce
  :AOuT <XRAW | YRAW | ZRAW | XCORrected | YCORrected |
    ZCORrected | MCORrected>

```

4.2.2 Queries

Many times, a command will have a corresponding query. Queries require a question mark at the end of the command header. If a query requires a parameter, place the question mark at the end of the header and before the query parameters.

For example:

```
FETCh:FIEld:DC? ALL
```

4.2.2.1 Infinity and NaN Values

As defined in the IEEE 488.2 standard, positive infinity is represented by 9.9E+37, negative infinity is represented by -9.9E+37, and NaN (not a number) is represented by 9.91E+37.

4.2.3 Optional Commands

If a command header is enclosed in brackets ([]), then it is optional. Do not include the brackets if you send the optional command to the instrument. For example, the following command messages are both valid:

```
FETCh:FIEld:DC? MAGNitude
```

```
FETCh:DC?
```

4.2.4 Short and Long Form

SCPI specifies a short and long form for its command headers. The command header is completely spelled out in the long form while it is abbreviated to the first three or four letters for short form. The following is an example of the same command in both short and long form:

```
SENSe:MODE HIFRequency
```

```
SENS:MODE HIFR
```

4.2.5 Number Suffix

When a command header is used to represent multiple instances of a given function of the instrument, the selection of which to use is designated by a numeric suffix attached to the command header. This suffix is applicable for both short and long forms.

Examples:

```
DIGital:OUTput1:FUNction MANual
```

```
DIG:OUT2:FUNC MANual
```

4.2.6 Multiple Commands in a Single Message

Many times, it is desirable to chain multiple commands and queries together into one message transmission. To do this, separate each command/query with a semicolon and be sure to include a colon before the next command, unless it is a common command which uses the "*" prefix.

If multiple commands are provided in a given message, the teslameter will process the commands in the order in which they were received. Subsequently, if multiple queries are included in chained message, the teslameter will respond to the queries in the order in which they were received.

As an example:

```
SENS:FIEL:RANG:AUTO 1;:UNIT:FIEL GAUS;:FETC:FIEL:DC? X;*OPC?
```

This command sets autorange to on, sets the field units to Gauss, requests a DC field measurement on the X channel, and then waits for an operation complete query response. The result that is returned might look like the following:

```
0.140850828588;1
```

4.2.6.1 Commands Within the Same Subsystem

Referring to the subsystem tree shown in section 4.2.1.2, if multiple commands within the same level of the SCPI tree are sent in the same chained message, the colon does not need to be included in order to reset the SCPI header path. An example of this is the RANGe and MODE headers within the SENSE subsystem.

As an example:

```
SENS:FIEL:RANG 0;MODE DC
```

This command sets the instrument to the smallest range, which also turns off auto-ranging, and then sets the mode to DC. Both of these commands are in the Sense subsystem.

4.2.7 Terminators

All data in a given SCPI message is encoded in the American Standard Code for Information Interchange (ASCII) format. A special ASCII character, the line feed (hex 0A, decimal 10), is required by the instrument to know where the SCPI message ends. The instrument also allows an optional carriage return (hex 0D, decimal 13) to precede the line feed.

4.2.8 Message Flow Control

It is important to remember that the user program is in charge of SCPI communication at all times, independent of the communications bus used to control the instrument. The instrument cannot initiate communication, determine which device should be transmitting at a given time, or guarantee timing between messages. All of this is the responsibility of the user program.

Most commands sent to the F71/F41 teslameter will execute within 100 ms of the last character being transmitted. However, the SCPI command protocol does not specify that an instrument return an acknowledge message when a given command is finished executing. Because of this, a user program could potentially flood and overload the instruments SCPI buffer.

Therefore, it is highly recommended to append the Operation Complete Query (*OPC?) to the end of any given command string. The operation complete query is a SCPI mandated IEEE 488.2 query that will cause the instrument to send a "1" back to the user program when all commands have been processed. This scheme closes the timing loop and provides the proper balance for a user program to maximize command throughput yet not risk overrunning the instrument SCPI buffer. *OPC? can be appended onto a single command or a chained SCPI message.

As an example:

```
SENS:FIEL:MODE DC;AVER:COUN 10;:UNIT:FIEL TESL;*OPC?
```

This command sets the field mode to DC, sets the averaging window count to 10 (100 ms), sets the field units to Tesla, and then waits for an operation complete query response. The result that is returned is:

```
1
```

4.3 Status and Error Reporting

4.3.1 Status System Overview

The F71/F41 teslameter implements a status system compliant to the SCPI-99 standard. The SCPI status system is derived from the status system called out in Chapter 11 of the IEEE 488.2 standard. The status system provides a method of recording and reporting instrument information. At the center of the status system is the status byte register. This register contains summary bits from other status registers, providing the user one register to periodically query to determine if further interrogation of the instrument is required.

In addition to the status byte and its complementary service request enable register, the status system is made up of standard, questionable, and operation status register sets. Each one of those register sets comprises three types of registers: condition, event, and enable. In addition, the status system contains an output buffer and error queue. A diagram of the status system is shown below.

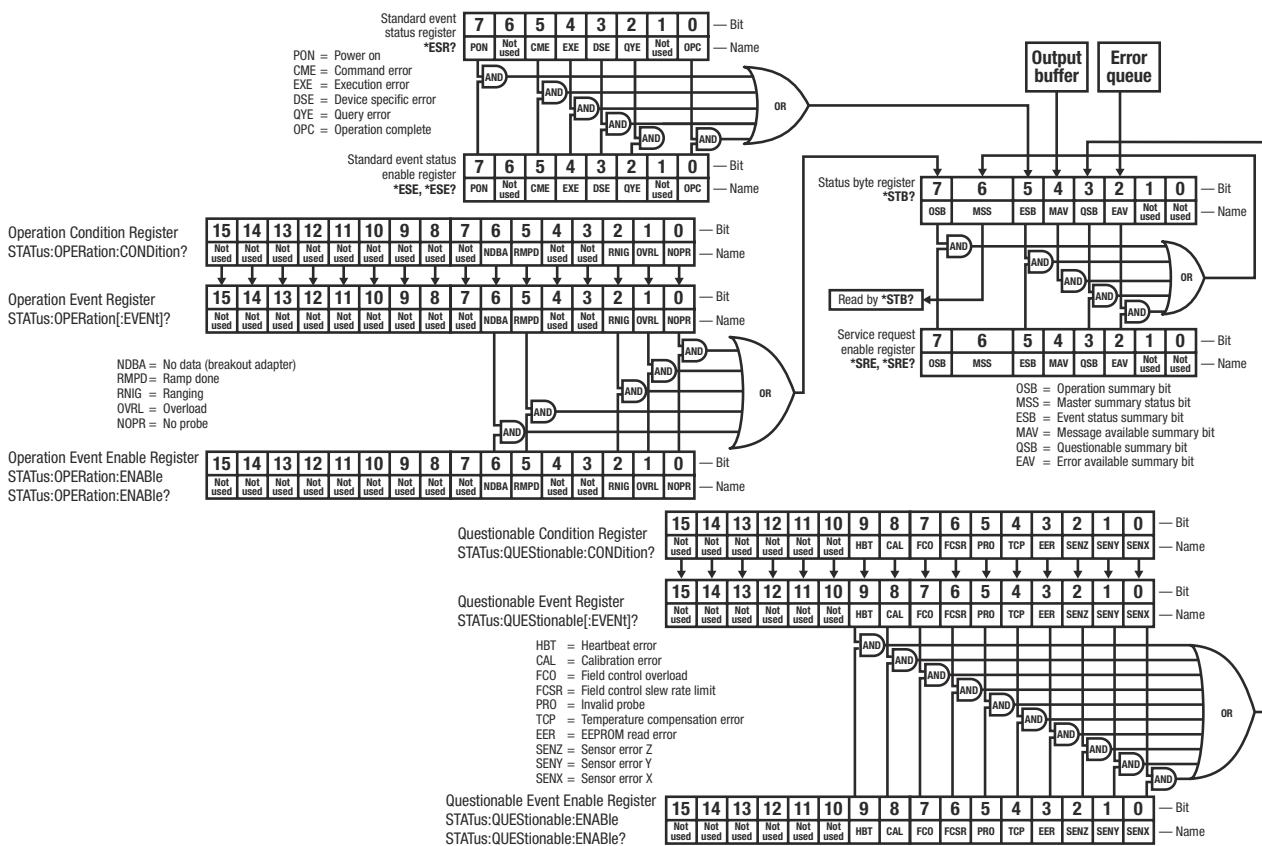

FIGURE 4-1 F71/F41 teslameter status system

4.3.1.1 Status Byte Register

The status byte register, typically referred to as the status byte, is a non-latching, read-only register that contains all of the summary bits from the register sets. The status of the summary bits are controlled from the register sets as explained in section 4.3.2.1 to section 4.3.2.5. The status byte also contains the Master Summary Status (MSS) bit. This bit is used to report if any of the summary bits are set via the *STB? command. The status of the MSS bit is controlled by the summary bits and the service request enable register.

4.3.1.2 Service Request Enable Register

The service request enable register determines which summary bits in the status byte will set the MSS bit of the status byte. The user may write to or read from the service request enable register. Each status byte summary bit is logically ANDed to the corresponding enable bit of the service request enable register. When a service request enable register bit is set by the user, and the corresponding summary bit is set in the status byte, the MSS bit of the status byte will be set.

4.3.1.3 Conditional Registers

Each register set (except the standard event register set) includes a condition register as shown in FIGURE 4-1. The condition register constantly monitors the instrument status. The data bits are real-time and are not latched or buffered. The register is read-only.

4.3.1.4 Event Registers

Each register set includes an event register as shown in FIGURE 4-1. Bits in the event register correspond to various system events and latch when the event occurs. Once an event bit is set, subsequent events corresponding to that bit are ignored. Set bits remain latched until the register is cleared by a query command (such as *ESR?) or a *CLS command. The register is read-only.

4.3.1.5 Enable Registers

Each register set includes an enable register as shown in FIGURE 4-1. An enable register determines which bits in the corresponding event register will set the summary bit for the register set in the status byte. The user may write to or read from an enable register. Each event register bit is logically ANDed to the corresponding enable bit of the enable register. When an enable register bit is set by the user, and the corresponding bit is set in the event register, the output (summary) of the register will be set, which in turn sets the master summary status bit of the status byte register.

4.3.1.6 Register Read/Write Behavior

4.3.1.6.1 Reading Registers

Any register in the status system may be read using the appropriate query command. Some registers clear when read, others do not (section 4.3.1.6.3). The response to a query will be a decimal value that corresponds to the binary-weighted sum of all bits in the register (TABLE 4-1). The actual query commands are described later throughout section 4.5.

Position	B7	B6	B5	B4	B3	B2	B1	B0
Decimal	128	64	32	16	8	4	2	1
Weighting	2^7	2^6	2^5	2^4	2^3	2^2	2^1	2^0

Example: If bits 0, 2, and 4 are set, a query of the register will return a decimal value of 21 ($1+4+16$)

TABLE 4-1 Binary weighting of an 8-bit register

4.3.1.6.2 Programming Registers

The only registers that may be programmed by the user are the enable registers. All other registers in the status system are read-only registers. To program an enable register, send a decimal value that corresponds to the desired binary-weighted sum of all bits in the register (TABLE 4-1). The actual commands are described throughout section 4.5.

4.3.1.6.3 Clearing Registers

The methods to clear each register are detailed in the table below.

Register	Method	Example
Condition registers	None: registers are not latched	—
Event registers: Standard event status register Operation event register	Query the event register	*ESR? (clears standard event status register)
	Send *CLS	*CLS (clears both registers)
	Power on instrument	—
Enable registers: Standard event status enable register Operation event enable register Service request enable register Questionable event enable register	Write 0 to the enable register	*ESE 0 (clears standard event status enable register)
	Power on instrument	—
	There are no commands that directly clear the status byte as the bits are non-latching; to clear individual summary bits clear the event register that corresponds to the summary bit—sending *CLS will clear all event registers which in turn clears the status byte	If bit 5 (ESB) of the status byte is set, send *ESR? to read the standard event status register and bit 5 will clear
Status byte	Power on instrument	—

TABLE 4-2 Register clear methods

4.3.2 Register Details

4.3.2.1 Status Byte Register

The summary messages from the event registers and the output buffer set or clear the summary bits of the status byte register (FIGURE 4-2). These summary bits are not latched. Clearing an event register will clear the corresponding summary bit in the status byte register. Reading all messages in the output buffer, including any pending queries, will clear the message available bit. Reading all errors out of the queue will clear the error available bit. The bits of the status byte register are described as follows:

- *Operation Summary (OSB), Bit (7)*: this bit is set when an enabled operation event has occurred.
- *Master Summary Status (MSS), Bit (6)*: this bit is set when a summary bit and the summary bit's corresponding enable bit in the service request enable register are set. A *STB? will read the status of the MSS bit (along with all of the summary bits), but also will not clear it. To clear the MSS bit, either clear the event register that set the summary bit or disable the summary bit in the service request Enable register.

In addition, with a GPIB interface, this bit is also defined as the Request Service (RQS) bit. In this case, when the RQS/MSS bit would be set, the service request hardware line would go high, indicating to the controller on the bus to query the status byte.

- *Summary (ESB), Bit (5)*: this bit is set when an enabled standard event has occurred.
- *Message Available (MAV), Bit (4)*: this bit is set when a message is available in the output buffer.
- *Questionable Summary (QSB), Bit (3)*: this bit is set when an enabled questionable event has occurred.

4.3.2.2 Service Request Enable Register

The service request enable register is programmed by the user and determines which summary bits of the status byte may set bit 6 (MSS). Enable bits are logically ANDed with the corresponding summary bits (FIGURE 4-2). Whenever a summary bit is set by an event register and its corresponding enable bit is set by the user, bit 6 will be set. The Service Request Enable command (*SRE) programs the Service Request Enable Register and the query command (*SRE?) reads it.

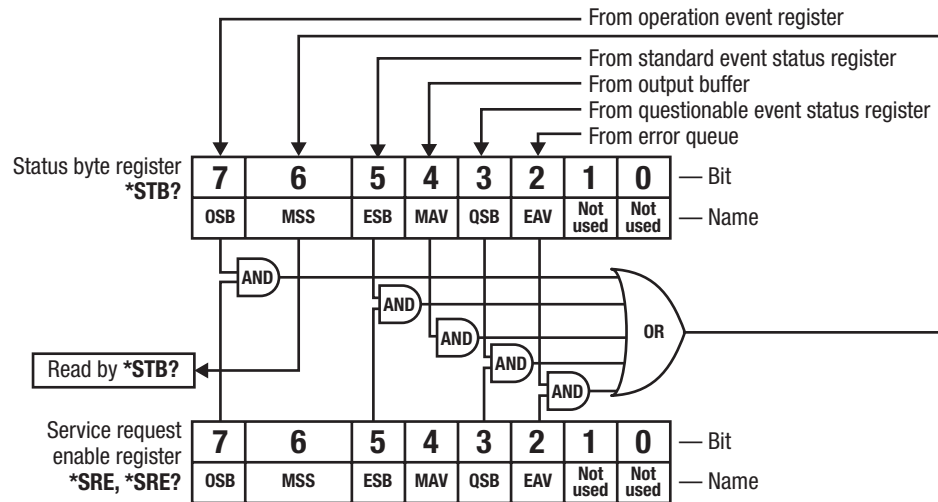

FIGURE 4-2 Status byte register and service request enable register

4.3.2.3 Standard Event Status Register Set

The standard event status register reports the following interface-related instrument events: power on detected, command syntax errors, command execution errors, query errors, and operation complete. Any or all of these events may be reported in the standard event summary bit through the enable register (FIGURE 4-3). The standard event status enable command (*ESE) programs the enable register and the query command (*ESE?) reads it. *ESR? reads and clears the standard event status register.

The used bits of the standard event register are described as follows:

- **Power On (PON), Bit (7):** this bit is set to indicate an instrument off-on transition.
- **Command Error (CME), Bit (5):** this bit is set if a command error has been detected since the last reading. This means that the instrument could not interpret the command due to a syntax error, an unrecognized header, unrecognized terminators, or an unsupported command.
- **Execution Error (EXE), Bit (4):** this bit is set if an execution error has been detected. This occurs when the instrument is instructed to do something not within its capabilities. A typical example of this are command parameters that are outside the instrument's acceptable bounds.
- **Device Specific Error (DSE), Bit (3):** this bit is set if an error occurs that does not fall into another category defined as a standard event. Examples include if the teslameter is unable to set its date/time or time zone.
- **Query Error (QYE), Bit (2):** this bit indicates a query error. It occurs rarely and involves loss of data because the output queue is full.
- **Operation Complete (OPC), Bit (0):** when *OPC is sent, this bit will be set when the instrument has completed all pending operations. The operation of this bit is not related to the *OPC? command, which is a separate interface feature (section 4.2.8).

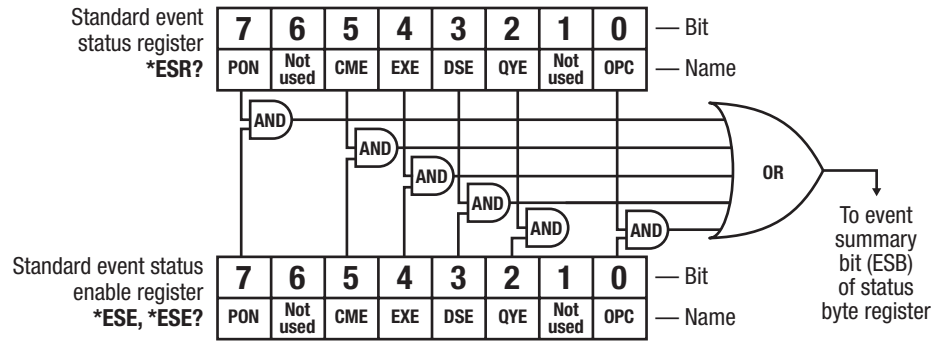

FIGURE 4-3 Standard event status register

4.3.2.4 Operation Event Register Set

The operation event register reports the instrument events that are considered part of normal operation. Any or all of these events may be reported in the operation event summary bit through the enable register (FIGURE 4-4.) The operation event enable command (`STATUS:OPERation:ENABle`) programs the enable register and the query command (`STATUS:OPERation:ENABle?`) reads it.

`STATUS:OPERation[:EVENT]?` reads and clears the operation event register.

`STATUS:OPERation:CONDition?` reads the operation condition register.

The used bits of the operation event register are described as follows:

- *No Data on Breakout Adapter (NDBA)*, Bit (6): indicates that a breakout adapter is attached and requires sensor calibration data stored on the connector EEPROM.
- *Ramp Done (RMPD)*, Bit (5): indicates that the instrument is not ramping the field control setpoint.
- *Ranging (RNIG)*, Bit (2): indicates that the instrument is transitioning between magnetic field ranges. No new field data is available during this transition.
- *Measurement Overload (OVRL)*, Bit (1): indicates that the field cannot be measured because it has exceeded the upper limit of the present range setting.
- *Probe Not Connected (NOPR)*, Bit (0): indicates that there is not a probe connected to the instrument.

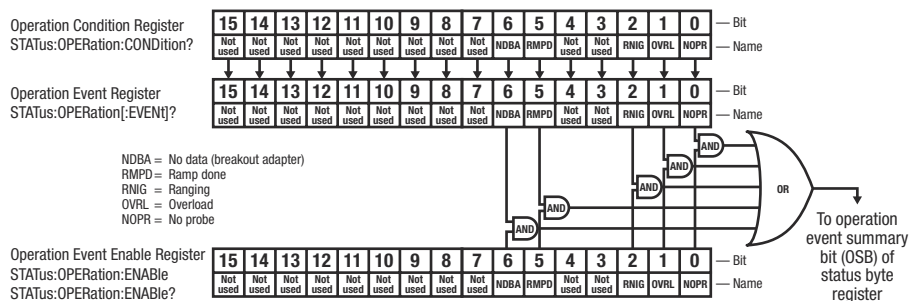

FIGURE 4-4 Operation event status register

4.3.2.5 Questionable Status Register Set

The questionable status register reports various states of the instrument that could indicate the quality of the output signal may be compromised. Any or all of these events may be reported in the questionable event summary bit through the enable register (FIGURE 4-5). The questionable event enable command (`STATUS:QUESTIONable:ENABLE`) programs the enable register and the query command (`STATUS:QUESTIONable:ENABLE?`) reads it.

`STATUS:QUESTIONable[:EVENT]?` reads and clears the operation event register.
`STATUS:QUESTIONable:CONDition?` reads the operation condition register.

The used bits of the operation event register are described as follows:

- *Inter processor Communication Error (HBT), Bit (9)*: indicates that there is no communication between the embedded microprocessor and the main microprocessor.
- *Calibration Error (CAL), Bit (8)*: indicates that the instrument did not pass calibration, contains corrupt calibration constants, contains default calibration constants, or has uninitialized calibration memory.
- *Field Control Overload (FCO), Bit (7)*: indicates that the field control option card has reached the limit of its voltage range but the measured field has not reached the field control setpoint.
- *Field Control Slew Rate Limit (FCSR), Bit (6)*: indicates that the rate of change of the field control output voltage is being limited by the slew rate parameter.
- *Invalid Probe (PRO), Bit (5)*: indicates that the connected probe is not compatible with the instrument.
- *Temperature Compensation Error (TCP), Bit (4)*: indicates that the connected probe has built-in temperature compensation but the instrument cannot read the temperature sensor.
- *EEPROM Read Error (EER), Bit (3)*: indicates that the instrument is unable to read the EEPROM (memory) of the connected probe.
- *Sensor Error Z (SENZ), Bit (2)*: indicates that the instrument detects that there is an open circuit on the Z channel; there is not a connection with the sensor.
- *Sensor Error Y (SENY), Bit (1)*: indicates that the instrument detects that there is an open circuit on the Y channel; there is not a connection with the sensor.
- *Sensor Error X (SENX), Bit (0)*: indicates that the instrument detects that there is an open circuit on the X channel; there is not a connection with the sensor.

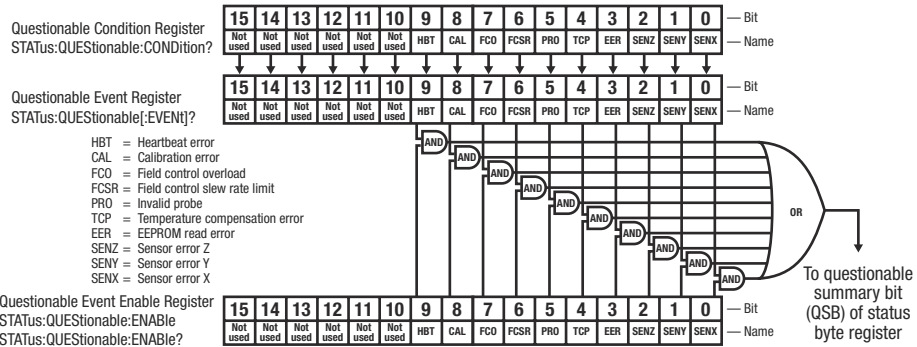

FIGURE 4-5 Questionable event status register

4.3.3 Error Messages

As called out in the SCPI-99 specification, the F71/F41 teslameter implements an error queue that contains coded error and status messages thrown during operation. SCPI 99 defines error messages with a negative (-) prefix as standard errors, common to all SCPI compliant instruments. Error messages with a positive prefix (+) are allocated to instrument manufacturers for instrument specific messages. Presently, the teslameter does not implement any instrument specific messages. All teslameter specific errors and status are captured in the status register system.

Coded error and status messages can be retrieved and cleared over the remote interface using the following commands:

```
SYSTem:ERRor:ALL?
```

```
SYSTem:ERRor:CLEar
```

```
SYSTem:ERRor:COUNT?
```

```
SYSTem:ERRor[:NEXT]?
```

The queue is implemented with a “First In, First Out” (FIFO) approach. This means, if the teslameter adds multiple messages to the queue in a given period of time, issuing the `SYSTem:ERRor[:NEXT]?` query will return the message that was added to the queue first, and, subsequently remove it from the queue. For further details on these error query commands, see section 4.5.

SCPI 99 categorizes its standard errors into logical groups that match bit definitions in the standard event status register. When the teslameter adds an error message to the queue, a bit in the standard event status register will be set as well. The error code range table shown below lists the error code ranges, title, and the corresponding bit in the standard event status register that gets set when the error or status is added to the queue.

Error code range	Description	Standard event register bit
-100 to -184	Command errors	5
-200 to -294	Execution errors	4
-300 to -365	Device specific errors	3
-400 to -440	Query errors	2

TABLE 4-3 Error code ranges

A comprehensive list of standard SCPI error codes descriptions can be found in chapters 21.8.9 through 21.8.16 of the official SCPI 99 standard, located on the IVI foundation website: <http://www.ivifoundation.org/docs/scpi-99.pdf>.



The F71/F41 teslameter does not implement every error code listed in the standard.

4.4 Remote Interfaces

4.4.1 USB

This section provides operational instructions for the three remote interfaces for the Lake Shore F71/F41 teslameter. Each of the three interfaces provided with the teslameter permit remote operation.

The USB interface provides a convenient way to connect to most modern computers. The USB interface is implemented as a virtual serial com port connection. This implementation provides a simple migration path for modifying existing RS-232 based remote interface software. It also provides a simpler means of communicating than a standard USB implementation.

4.4.1.1 Physical Connection

The teslameter has a B-type USB connector on the rear panel. This is the standard connector used on USB peripheral devices, and it allows the common USB A-type to B-type cable to be used to connect the teslameter to a host PC. The pin assignments for A-type and B-type connectors are shown in section 6.7. The maximum length of a USB cable, as defined by the USB 2.0 standard, is 5 m (16.4 ft). This length can be extended using USB hubs every 5 m (16.4 ft) up to five times, for a maximum total length of 30 m (98.4 ft).

4.4.1.2 Hardware Support

The USB interface emulates an RS-232 serial port at a fixed 115,200 baud rate, but with the physical connections of a USB. This programming interface requires a certain configuration to communicate properly with the teslameter. The proper configuration parameters are listed in the table below.

Baud rate	115,200
Data bits	8
Parity	None
Stop bits	1
Flow control	RTS/CTS

TABLE 4-4 *Host com port configuration*

The USB hardware connection uses the full speed (12,000,000 bit/s) profile of the USB 2.0 standard; however, since the interface uses a virtual serial com port at a fixed data rate, the data throughput is still limited to a baud rate of 115,200 bit/s.

4.4.1.3 Installing the USB Driver

The USB driver is available through Windows® Update. This is the recommended method for installing the driver, as it will ensure that you always have the latest version of the driver installed. If you are unable to install the driver from Windows® Update, it may be downloaded from:

<https://www.lakeshore.com/resources/software/drivers>.

4.4.2 Ethernet

The Ethernet interface provides a means of connecting the F71/F41 teslameter to a network. These networks provide the ability to communicate across large distances, often using existing equipment (the internet, pre-existing local networks). The Ethernet interface of the teslameter provides the ability to use TCP socket connections (section 4.4.2.4) to send commands and queries to the instrument using the common command set detailed in section 4.5.1.

IP address	DHCP or Manual
Port	7777

TABLE 4-5 Ethernet settings

4.4.2.1 Ethernet Configuration

Configuration and status for these network configurations can be found from the front panel by tapping the Settings menu (top left corner of the screen) to go to the navigation drawer. Then tap System settings. Ethernet settings can be found in the Connectivity box.

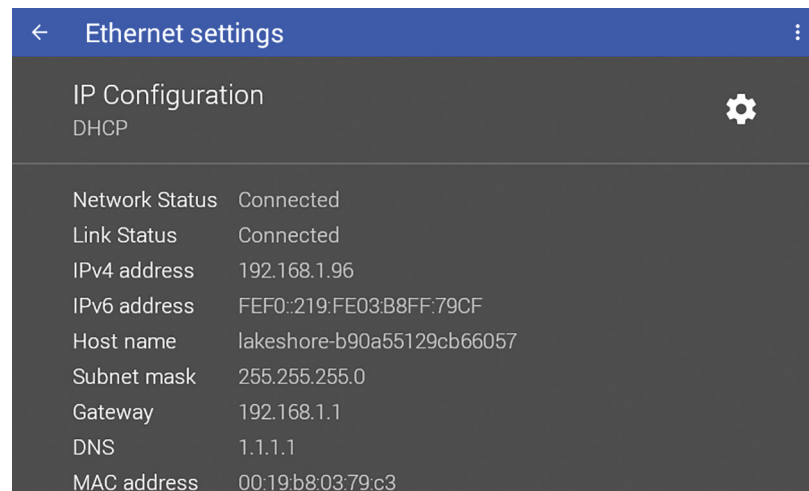

FIGURE 4-6 Ethernet settings

4.4.2.2 Network Address Parameters

Network address parameters include the IP address, the subnet mask, gateway address, and DNS address. The network address parameters of the teslameter can be configured using one of two methods: DHCP or Static-IP.

- **IP Address:** an IP address is required for a device to communicate using TCP/IP, which is the protocol generally used for Ethernet devices and the teslameter. The teslameter supports both IPv4 and IPv6. However, for simplicity, references to the IP protocol from this point forward will be referring to IPv4.

An IP address is a 32-bit logical address used to differentiate devices on a network. It is most often given in dotted decimal notation, such as nnn.nnn.nnn.nnn where nnn is a decimal number from 0 to 255.

- **Subnet Mask:** a sub network, or subnet, is a group of devices within a network that have a common, designated IP address routing prefix. A subnet mask is a 32-bit “bit mask” that signifies which part of the IP address represents the subnet routing prefix, and which part represents the device’s address on the subnet. A subnet mask is most often given in dotted decimal notation, such as nnn.nnn.nnn.nnn where nnn is a decimal number from 0 to 255. When converted to a binary notation, the 32-bit subnet mask should consist of a contiguous group of ones, followed by a contiguous group of zeros. The ones represent which bits in the IP address refer to the subnet, and the zeros represent which bits refer to the device address. For example, the default Static-IP Address of the teslameter is 192.168.0.128, and the default static subnet mask is 255.255.255.0. Converting this subnet mask to binary shows that the first 24 bits are ones, and the last 8 bits are zeros. This means that the first 24 bits of the Static-IP Address (192.168.0) represent the subnet, and the last 8 bits (12) represent the device.
- **Gateway Address:** a gateway is a network traffic routing device that is used to route communication between networks. If a gateway is not used, then devices on a network can only communicate with other devices on that same network. A gateway address is the IP address of the gateway on a network. Contact the network administrator for the gateway address for your network.
- **DNS Address:** a Domain Name System (DNS) is a service that translates names into IP addresses. This service allows for using human readable names for devices on a network. As an example, when a web browser attempts to retrieve the web page at www.lakeshore.com, the browser first performs a forward-lookup on the assigned DNS server to attempt to retrieve the IP address that is represented by the name www.lakeshore.com. If successful, the web browser then uses the retrieved IP address to communicate with the web server that hosts the website at www.lakeshore.com.

4.4.2.3 Network Address Configuration Methods

The network address parameters of the teslameter can be configured using one of two methods: DHCP or Static-IP. DHCP is an automatic configuration method while Static-IP requires manual configuration. If supported by the server, DHCP can also be used to automatically configure DNS server addresses, as well as IP address parameters.

Dynamic Host Configuration Protocol (DHCP): DHCP is a method of automatically configuring the IP address, subnet mask, and gateway of Ethernet devices on a network. This method provides simple automatic configuration for users connecting to a network that provides a DHCP server. The network DHCP server will provide an IP address, subnet mask, and gateway address. Depending on the DHCP server configuration, it may

also provide primary DNS and secondary DNS addresses as well. DHCP is the simplest method of IP configuration. DHCP does have the disadvantage of not necessarily preserving the IP address through a device reconfiguration, as well as the possibility of being automatically reconfigured when the DHCP “lease” expires. Contact your network administrator to find out the DHCP lease policy on your network.

Static-IP: Static-IP is a method of manually configuring the IP address, subnet mask, and gateway of network enabled devices. When using the Static-IP method, the IP address, subnet mask, and gateway must be configured appropriately for the connected network, or for the connected PC, in order to establish connection to the network. A major advantage to the Static-IP method is that the IP address will not change during device reconfiguration (power cycle). Disadvantages of using the Static-IP method include the requirement of knowing how your network is configured in order to choose the correct configuration parameters.

Domain Name: A domain is a collection of network devices that are managed according to some common characteristic of its members. Domains can contain subdomains, which are subsets within the domain. The hierarchy can contain several dot-separated levels which flow from right to left. For example, lakeshore.com contains the top-level-domain “com” and the subdomain “lakeshore”. When using the Domain Name System (DNS) to connect to a specific host device on a network, the device’s hostname is tacked onto the left of the domain name. For example, the “www” in www.lakeshore.com refers to the Lake Shore web server, located within the internet domain “lakeshore.com.”

4.4.2.4 TCP Socket Communication

A TCP socket connection interface is provided as the communication medium for the network interface of the F71/F41 teslameter. A TCP socket connection, or simply “socket connection”, is a common connection protocol used by Ethernet devices. The Transmission Control Protocol (TCP) is commonly used for creating a communication channel between one program on one computer and one program on another computer, for example a web browser on a PC and a web server on the Internet.

In the case of the teslameter, the protocol is used to create a communication channel between one program on one computer and the command line interface of the teslameter. TCP uses error correction and collision avoidance schemes that make it a very reliable form of network communication, but has drawbacks of having non-deterministic timing, and can encounter relatively large delays depending on network conditions. These delays can be on the order of seconds. Sockets use port numbers to identify sending and receiving endpoints on network devices. This allows for multiple separate communication links to exist on each device.



The port number used for TCP socket connections on the teslameter is 7777 by default. The port number can be configured from the Connectivity screen in System settings (top left corner of the screen).

4.4.3 SCPI over TCP

There may be scenarios where the user desires to have the teslameter connected to the internet but does not want anyone to be able to connect to the teslameter and start controlling it. The SCPI over TCP setting allows for this. If the setting is disabled, network connections are still allowed, allowing firmware or autodate time to still function. For example, remote control of the teslameter will not be allowed even if another user knows the IP address and socket of the teslameter.

In order to issue SCPI commands over TCP and remotely control the instrument, this setting needs to be enabled. This can be done by touching the switch, as shown below.

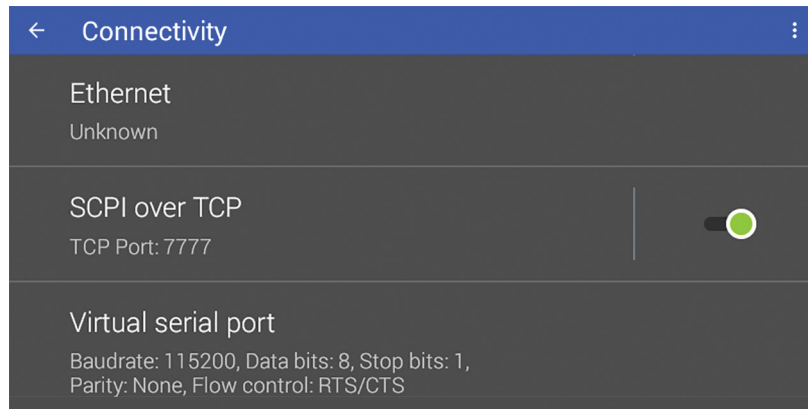

FIGURE 4-7 SCPI over TCP

4.4.4 GPIB

A GPIB adapter is available for use with MeasureReady® instruments. This adapter provides GPIB communication to instruments that don't have built-in GPIB. For more information, see:

<https://www.lakeshore.com/products/product-detail/measureready/gpib-adapter/>

4.5 Command Summary

This section provides a listing of the interface commands.

4.5.1 Common Commands

The following commands and queries are specified in both IEEE 488.2 and SCPI-99.

Command Format Remarks

***CLS**

***CLS**

Clears status data structures and forces the device in to Operation Complete Command Idle State and the Operation Complete Query Idle State. If the Clear Status command immediately follows a <PROGRAM MESSAGE TERMINATOR>, the output queue and the MAV bit will be cleared because any new <PROGRAM MESSAGE> after a <PROGRAM MESSAGE TERMINATOR> clears the Output Queue.

The table below explains the resetting actions of *CLS as they relate to other reset commands.

Device functional class	Device functional layer					
	Device specific	Device status	Standard status	Common operation	Message exchange interface	IEEE 488.1 I.F.
Configuration settings	–			–		–
Current device settings	–	–	–	–		
Device states	–	+		+	–	
Operation modes					–	
Memorized device settings	–			–		
Protected settings	–			–		
Power-on reset flags	–			–		
Macros	–			–		
Device events		+	+			–

+ Function not affected by *CLS

– Function affected by *CLS

<no_entry> not applicable

Command Format Parameter Example Remarks

***ESE**

*ESE <decimal numeric program data>
<decimal numeric program data> 0 – 255

***ESE 32**

Sets the standard event status enable register bits. The parameter, when rounded to an integer value and expressed in base 2, represents the bit values of the standard event status enable register.

An out-of-range parameter will cause an execution error.

Query Format Remarks

***ESE?**

***ESE?**

Returns the current contents of the standard event status enable bits. The returned value is defined as a <NR1 NUMERIC RESPONSE DATA> element in the range of 0 – 255. The integer value expressed in base 2 represents the bit values of the standard event status enable register.

<hr style="border: 0.5px solid black; margin-bottom: 10px;"/> Query Format Remarks	<p>*ESR? *ESR? Returns the current contents of the standard event status register. Reading the standard event status register clears it. The returned value is defined as a <NR1 NUMERIC RESPONSE DATA> element in the range of 0 – 255. The integer value expressed in base 2 represents the bit values of the standard event status register.</p>
<hr style="border: 0.5px solid black; margin-bottom: 10px;"/> Query Format Remarks	<p>*IDN? *IDN? Returns the unique identification of the device over the system interface. The response is separated into four fields separated by commas; Manufacturer, Model, Serial Number, and Firmware level.</p>
<hr style="border: 0.5px solid black; margin-bottom: 10px;"/> Command Format Remarks	<p>*OPC *OPC Causes the device to generate the operation complete message in the standard event status register when all pending selected device operation have been finished. This command allows synchronization between a controller and several devices. The OPC event-bit in the standard event status register (ESR) is used to effect the synchronization.</p>
<hr style="border: 0.5px solid black; margin-bottom: 10px;"/> Query Format Remarks	<p>*OPC? *OPC? Places an ASCII character “1” into the device’s output queue when all pending selected device operations have been finished. This query allows synchronization between a controller and a device using the MAV bit in the status byte or a read of the output queue. NOTE: Unlike the *OPC command, the *OPC? query does not affect the OPC event-bit in the ESR.</p>
<hr style="border: 0.5px solid black; margin-bottom: 10px;"/> Command Format Remarks	<p>*RST *RST Performs a device reset.</p> <p>The Reset command does the following:</p> <ol style="list-style-type: none"> 1. Except as explicitly excluded below, sets the device-specific functions to a known state that is independent of the past-use history of the device. 2. Sets the macro defined by *DDT to a device-defined state. 3. Disables macros. 4. Forces the device into the OCIS state. 5. Forces the device into the OQIS state. <p>The Reset command does not affect the following:</p> <ol style="list-style-type: none"> 1. The state of the IEEE 488.1 interface. 2. The selected IEEE 488.1 address of the device. 3. The output queue. 4. Any event enable setting, including the standard event status enable register settings. 5. Any event register setting, including the standard event status register settings. 6. The power-on-status-clear flag setting. 7. Macros defined with the define macro contents command.

8. Calibration data that affects device specifications.
9. The protected user data query response.
10. The resource description transfer query response.
11. The service request enable register setting.
12. The parallel poll enable register setting.
13. The memory registers associated with *SAV.

<hr/> Command Format Parameter Example Remarks	<p>*SRE</p> <p>*SRE <decimal numeric program data> <decimal numeric program data> 0 – 255</p> <p>*SRE 10</p> <p>Sets the service request enable register bits. The parameter rounded to an integer, expressed in base 2, represents the bit values of the standard request enable register. For all bits except bit 6 (bit 6 is ignored), a bit value of one indicates an enabled condition. A bit value of zero indicates a disabled condition.</p>
<hr/> Query Format Remarks	<p>*SRE?</p> <p>*SRE?</p> <p>Returns the current contents of the service request enable register. The returned value is defined as a <NR1 NUMERIC RESPONSE DATA> element. This response will be in the range of 0 – 63 or 128 – 191. When converted to binary, the response represents the current bit values of the standard request enable register. Bit 6 will always be zero.</p>
<hr/> Query Format Remarks	<p>*STB?</p> <p>*STB?</p> <p>Returns the status byte and master summary status bit. The returned value is defined as a <NR1 NUMERIC RESPONSE DATA> element in the range of 0 – 255. When expressed in binary, the response represents the bit values of the status byte register. Bit 6 contains the master summary status bit.</p>
<hr/> Query Format Remarks	<p>*TST?</p> <p>*TST?</p> <p>Causes an internal self-test and places a response into the output queue, indicating whether or not the device completed the self-test without any detected errors.</p> <p>Upon completion of *TST?, the device settings will be restored to their values prior to the *TST?.</p> <p>The returned value is defined as a <NR1 NUMERIC RESPONSE DATA> element in the range of -32767 – 32767. A response of zero indicates the self-test has completed without errors detected. A nonzero response indicates the self-test was not completed or was completed with errors detected.</p>
<hr/> Command Format Remarks	<p>*WAI</p> <p>*WAI</p> <p>Prevents the device from executing any further commands or queries until the non-operation-pending flag is true.</p>

4.5.2 SCPI Subsystem Commands

The following commands and queries are derived from the SCPI 99 standard.

4.5.2.1 How to Read SCPI Commands

SCPI allows for either abbreviated or verbose commands. The abbreviation option is shown capitalized in this document. Note that SCPI commands are not case sensitive. Symbols used have the following meanings:

```
<>    must be replaced by a parameter
[]     optional keyword or parameter
|     OR
```

4.5.2.2 Example

Consider the following SCPI command:

Command	Parameter(s)	Description
<code>SENSe:AVERage:COUNT</code>	<code><DEFAULT MAXimum MINimum integer number of 10ms samples></code>	Configures the length of the averaging window.

The following are all valid uses of this command:

```
sens:average:coun 20
SENSe:AVER:Count max
Sense:aver:coun Default
```

4.5.2.3 SYSTem Commands

Command	Parameter(s)	Description
<code>SYSTem:AUTODATETIME?</code>		Returns whether the instrument automatically sets the date and time when connected to the internet.
<code>SYSTem:AUTODATETIME</code>	<code><Boolean 0 = FALSE, 1 = TRUE></code>	Sets whether the instrument automatically sets the date and time when connected to the internet.
<code>SYSTem:BEEPer:VOLUME?</code>		Returns the volume setting as a percentage of maximum.
<code>SYSTem:BEEPer:VOLUME</code>	<code><integer></code>	Sets the volume of the instrument as a percentage of maximum.
<code>SYSTem:DATE?</code>		Returns the year, month, and day.
<code>SYSTem:DATE</code>	<code><year>, <month>, <day></code>	Sets the date.
<code>SYSTem:ERRor:ALL?</code>		Returns all SCPI errors in the queue and clears the queue.
<code>SYSTem:ERRor:CLEar</code>		Clears the error queue.
<code>SYSTem:ERRor:COUNT?</code>		Returns the number of errors in the queue.
<code>SYSTem:ERRor[:NEXT]?</code>		Returns the most recent error in the queue and removes it.
<code>SYSTem:FACTORYRESET</code>		Resets all settings to their factory defaults. This includes System settings.

Command	Parameter(s)	Description
SYSTem:KLOCK?		Returns whether the front panel touch screen is locked.
SYSTem:KLOCK	<Boolean 0 = FALSE, 1 = TRUE>	Locks and unlocks the front panel touch screen.
SYSTem:PRESet		Resets the measurement settings to their default values.
SYSTem:TIME?		Returns the hour, minute, and second in 24 hour time.
SYSTem:TIME	<hour>, <minute>, <second>	Sets the time in 24 hour time.
SYSTem:TZONE?		Returns the time zone hour.
SYSTem:TZONE	<hour>	Sets the time zone.
SYSTem:VERSion?		Returns the SCPI definition version that the instrument complies with.

4.5.2.4 Measurement Queries

Command	Parameter(s)	Description
FETCh:BUFFer:CLear		Clears all data from the measurement buffer.
FETCh:BUFFer:DC?		Returns up to 128 timestamped field readings and input states from a buffer. Querying the readings clears the buffer.
FETCh:BUFFer:FORMat?		Returns header information for the data that is returned by the DC buffer query.
FETCh:CRESt?	< [MAGNitude] X Y Z ALL >	Returns the crest factor of a specific axis or all axes. Not available in DC mode.
FETCh:DC?	< [MAGNitude] X Y Z ALL >	Returns the DC measurement of the total magnitude, a specific axis, or all axes. Not available in high-frequency mode.
FETCh:FREQuency?		Returns the dominant frequency. Not available in DC mode.
FETCh:MAXimum?		Returns the max hold value.
FETCh:MAXPeak?	< [X] Y Z ALL >	Returns the highest peak value measured since the value was reset.
FETCh:MINimum?		Returns the min hold value.
FETCh:MINPeak?	< [X] Y Z ALL >	Returns the lowest peak value measured since the value was reset.
FETCh:PEAK?	< [X] Y Z ALL >	Returns the peak-to-peak measurement of a specific axis or all axes. Not available in DC mode.
FETCh:RELative?		Returns the difference between the present field measurement and the relative baseline value.

Command	Parameter(s)	Description
FETCh:RMS?	< [MAGNitude] X Y Z ALL >	Returns the RMS measurement of the total magnitude, a specific axis, or all axes. Not available in DC mode.
FETCh:TEMPerature?		Returns the present temperature reading.

4.5.2.5 Measurement Setup

Command	Parameter(s)	Description
SENSe:AVERage:COUNT?		Returns the number of 10 ms samples in the averaging window.
SENSe:AVERage:COUNT	<Default MAXimum MINimum integer number of 10ms samples >	Configures the length of the averaging window. Default value is 20 (200 ms).
SENSe:CRYO?		Returns whether cryogenic operation is enabled.
SENSe:CRYO	<Boolean 0 = FALSE, 1 = TRUE >	Enables or disables cryogenic operation.
SENSe:FILTer:BPASs:CENTer?		Returns the center frequency of the band pass filter.
SENSe:FILTer:BPASs:CENTer	<frequency >	Configures the center frequency of the band pass filter.
SENSe:FILTer:HPASs:CUToff?		Returns the cutoff frequency of the high pass filter.
SENSe:FILTer:HPASs:CUToff	<frequency >	Configures the cutoff frequency of the high pass filter.
SENSe:FILTer:LPASs:CUToff?		Returns the cutoff frequency of the low pass filter.
SENSe:FILTer:LPASs:CUToff	<frequency >	Configures the cutoff frequency of the low pass filter.
SENSe:FILTer:[STATE?]		Returns whether the filter is enabled.
SENSe:FILTer:[STATE]	<Boolean >	Configures if the filter is enabled.
SENSe:FILTer:TYPE?		Returns the present filter type.
SENSe:FILTer:TYPE	<HPASs LPASs BPASs >	Configures which filter type is applied when filtering is enabled.
SENSe:MODE?		Returns the present mode.
SENSe:MODE	<DC AC HIFrequency >	Configures the measurement mode.
SENSe:MRESet		Resets the max and min hold values to the present reading.
SENSe:PCOMpensation?		Returns whether probe frequency compensation is enabled.
SENSe:PCOMpensation	<Boolean 0 = FALSE, 1 = TRUE >	Enables or disables probe frequency compensation.
SENSe:QUALifier?		Returns whether the qualifier is enabled or disabled.
SENSe:QUALifier	<bool >	Enables or disables the qualifier.

Command	Parameter(s)	Description
<code>SENSe:QUALifier:CONDition?</code>		Returns a bool that indicates whether the qualifier threshold condition is met.
<code>SENSe:QUALifier:LATCh?</code>		Returns whether the condition remains true once the threshold condition is met.
<code>SENSe:QUALifier:LATCh</code>	<code><bool></code>	Sets whether the condition remains true once the threshold condition is met.
<code>SENSe:QUALifier:LRESet</code>		Resets the condition state when it is latched.
<code>SENSe:QUALifier:THREShold?</code>		Returns the threshold mode, lower field threshold, and upper field threshold.
<code>SENSe:QUALifier:THREShold</code>	<code><OVER UNDER BETWEEN OUTSide ABSBetween ABSOutSide>, <float>, [<float>]</code>	Sets the qualifier threshold. The first parameter is the threshold mode. The second parameter is the lower threshold field value. The third parameter is the upper threshold field value. The third parameter is not needed if the threshold mode is OVER or UNDER.
<code>SENSe:RANGe?</code>		Returns the present range.
<code>SENSe:RANGe</code>	<code><field value></code>	Configures the instrument to use the most appropriate range for the given field value. This command disables autoranging.
<code>SENSe:RANGe:AUTO?</code>		Returns whether autoranging is presently enabled.
<code>SENSe:RANGe:AUTO</code>	<code><Boolean 0 = FALSE, 1 = TRUE></code>	Enables or disables autoranging.
<code>SENSe:RELative:TARE</code>		Sets the present measurement as the baseline field value.
<code>SENSe:RELative:BASE-line?</code>		Returns the baseline field value.
<code>SENSe:RELative:BASE-line</code>	<code><field value></code>	Configures the baseline field value.
<code>SENSe:TCOMPensation:TSource?</code>		Returns the temperature compensation temperature measurement source.
<code>SENSe:TCOMPensation:TSource</code>	<code><PROBE MTEMPerature NONE></code>	Configures temperature compensation to use the probe thermistor (PROB) or a manual value (MTEM) for the temperature measurement source. It can also disable compensation (NONE).
<code>SENSe:TCOMPensation:MTEMPerature?</code>		Returns the manual temperature value.
<code>SENSe:TCOMPensation:MTEMPerature</code>	<code><temperature in Celsius></code>	Configures the manual temperature value.

4.5.2.6 Analog Output

Command	Parameter(s)	Description
SOURce:AOUT?		Returns the current analog output configuration designator.
SOURce:AOUT	<XRAW YRAW ZRAW XCORrected YCORrected ZCORrected MCOReCted OFF>	Sets the source for the analog output: XRAW = Raw X YRAW = RAW Y ZRAW = Raw Z XCORrected = Corrected X YCORrected = Corrected Y ZCORrected = Corrected Z MCOReCted = Corrected magnitude OFF = Output disabled
SOURce:AOUT:BASELine?		Returns the baseline field value at which the corrected analog output equals zero.
SOURce:AOUT:BASELine	<float>	Sets the baseline field value at which the corrected analog output equals zero.
SOURce:AOUT:SFACTOR?		Returns the corrected analog out scaling factor.
SOURce:AOUT:SFACTOR	<float>	Sets the corrected analog out scale factor in volts per unit field.

4.5.2.7 Digital I/O

Command	Parameter(s)	Description
DIGital:IDATa?		Returns the integer representation of the input states.
DIGital:INPut#:FUNctIon?		Returns the present function for input #.
DIGital:INPut#:FUNctIon	<MANual MRESet TARE LRESet>	Configures the function of the input #. NONE does no action. MRESet resets the max and min hold values when the input transitions high. TARE sets the relative baseline to present the measurement value. LRESet resets the qualifier latch.
DIGital:OSETting?		Returns the integer representation of the output setting.
DIGital:OSETting	<integer representation>	Configures the output setting which determines the states of outputs assigned the MANual function.
DIGital:OUTPut#:FUNctIon?		
DIGital:OUTPut#:FUNctIon	<MANual FCRamp- ing QUALifier>	Configures the function of the output relay #. MANual sets the state of the output according to the OSETting value. FCRamping closes the output relay when the field control setpoint is ramping to a new value. Qualifier closes the relay when the qualifier condition is met or the condition is latched.

4.5.2.8 Probe Data Queries

Command	Parameter(s)	Description
PROBe:AXES?		Returns the probe number of axes.
PROBe:CALDate?		Returns the calibration date.
PROBe:MODe1?		Returns the model number.
PROBe:PTYPe?		Returns the probe type.
PROBe:SNUMber?		Returns the serial number.
PROBe:SORientation?		Returns the sensor orientation.
PROBe:STYPe?		Returns the sensor type.
PROBe:TCOMpensation?		Returns whether the probe is temperature compensated.

4.5.2.9 Unit Selection

Command	Parameter(s)	Description
UNIT?		Returns the field unit setting.
UNIT	<TESLa GAUSS>	Configures the field unit setting. Tesla is the default.
UNIT:CGSDISABLE?		Returns whether a user can change their field measurement units to gauss.
UNIT:CGSDISABLE	<Boolean 0 = FALSE, 1 = TRUE>	Configures whether a user can change their field measurement units to gauss.

4.5.2.10 Field Control

Command	Parameter(s)	Description
SOURce:FIELD:CLLoop:GAIN?		Returns the P value of the PI control.
SOURce:FIELD:CLLoop:GAIN	<P value>	Sets the P value of the PI control.
SOURce:FIELD:CLLoop:INTEgral?		Returns the I value of the PI control.
SOURce:FIELD:CLLoop:INTEgral	<I value>	Sets the I value of the PI control.
SOURce:FIELD:CLLoop:RAMPrate?		Returns the rate at which the setpoint moves toward the final setpoint (ramp rate).
SOURce:FIELD:CLLoop:RAMPrate	<field units per second>	Sets the rate at which the setpoint moves toward the final setpoint (ramp rate).
SOURce:FIELD:CLLoop:SETPoint?		Returns the final field setpoint.
SOURce:FIELD:CLLoop:SETPoint	<setpoint in field units>	Sets the final setpoint.
SOURce:FIELD:CLLoop:LINearization?		Returns whether magnet system linearization is enabled.
SOURce:FIELD:CLLoop:LINearization	<bool>	Enables or disables magnet system linearization.
SOURce:FIELD:MODE?		Returns the present field control mode.
SOURce:FIELD:MODE	<CLLoop OPLoop>	Sets field control to open loop or closed loop mode.
SOURce:FIELD:OPLoop:VOLTage?		Returns the open loop voltage output setting.
SOURce:FIELD:OPLoop:VOLTage	<voltages>	Sets the open loop voltage output setting.
SOURce:FIELD:SLEW?		Returns the maximum rate of change of the voltage output.
SOURce:FIELD:SLEW	<volts per second>	Sets the maximum rate of change of the voltage output.
SOURce:FIELD:STATe?		Returns whether field control is on or off.
SOURce:FIELD:STATe	<Boolean 0 = FALSE, 1 = TRUE>	Turns field control on and off.
SOURce:FIELD:VLIMit?		Returns the voltage output limit.
SOURce:FIELD:VLIMit	<voltage>	Sets the voltage output limit.

Chapter 5: Probes and Accessories

5.1 General

This chapter provides information on standard probes and the accessories available for the F71/F41 teslameter.

5.2 Models

The list of F71/F41 teslameter model numbers follows:

Model	Description
F41	F41 teslameter
F71	F71 teslameter

TABLE 5-1 Model description

Full details on FP Series probes are provided on our website. Please see: <https://www.lakeshore.com/products/categories/overview/magnetic-products/hall-probes/fp-series-hall-probes>.

5.3 Accessories

Accessories are devices that perform a secondary duty as an aid or refinement to the primary unit. Contact Lake Shore for information on accessories.

Model	Description
MR-GPIB-USB	GPIB adapter
RMX-1/2	Half rack mount kit
RMX-2	Dual half rack mount kit
G-106-741	Digital I/O 6-pin connector

TABLE 5-2 Accessories

5.4 Rack Mounting

The teslameter can be installed into a half rack or dual half rack mount using the optional Lake Shore rack mount kits. The kits contain the necessary parts to mount one instrument with the provided blank, or two instruments side by side in a rack mount space, 483 mm (19 in) wide by 88.9 mm (3.5 in) high. See <https://www.lakeshore.com/rack-kit/> for full details.



Ensure that there is a 25 mm (1 in) clearance on both sides of the instrument after rack mounting.

Chapter 6: Service

6.1 Overview

This chapter provides basic service information for the F71/F41 teslameter. Customer service of the product is limited to the information presented in this chapter. Lake Shore service personnel should be consulted if the instrument requires repair.



The purpose of this chapter is to help determine if there is a simple solution to your problem, or if something is out of working order. If you verify that there is something wrong with your instrument, do not attempt to open the instrument as there are no serviceable parts inside; contact Lake Shore for service (section 6.9).

6.2 General Troubleshooting

If the F71/F41 teslameter registers a reading that is not appropriate to the situation, try the following solutions.

- Refer to section 6.5 for a list of error messages
- Cycle the power
- Reset the instrument to factory defaults (section 3.5.13)
- To determine whether the issue is with the probe or the instrument, test the instrument with a different probe, or try disconnecting and reconnecting the probe
- If none of these solutions work, contact Lake Shore (section 6.9)

6.3 USB Troubleshooting

This section provides USB interface troubleshooting for issues that arise with new installations, existing installations, and intermittent lockups.

6.3.1 New Installation

1. Check that the instrument's interface is set to USB.
2. Check that the USB driver is installed properly and that the device is functioning. In Microsoft Windows®, the device status can be checked using Device Manager by right-clicking **Lake Shore Instrument** under Ports (COM & LPT) or Other Devices and then clicking Properties. Refer to Chapter 4 for details on installing the USB driver.
3. Check that the correct com port is being used. In Microsoft Windows®, the com port number can be checked using Device Manager under Ports (COM & LPT).
4. Check that the correct settings are being used for communication. Refer to Chapter 5 for details on installing the USB driver.
5. Check cable connections and length.
6. Send the message terminator.
7. Send the entire message string at one time including the terminator. (Many terminal emulation programs do not.)
8. Send only one simple command at a time until communication is established.
9. Be sure to spell commands correctly and use proper syntax.

6.3.2 Existing Installation No Longer Working

1. Power the instrument off, then on again to see if it is a soft failure.
2. Power the computer off, then on again to see if communication port is locked up.
3. Check all cable connections.
4. Check that the com port assignment has not been changed. In Microsoft Windows®, the com port number can be checked in the Device Manager window, under the **Ports (COM & LPT)** device type.
5. Check that the USB driver is installed properly and that the device is functioning. In Microsoft Windows®, the device status can be checked using Device Manager by right-clicking **Lake Shore Instrument** under Ports (COM & LPT) or Other Devices and then clicking Properties.

6.3.3 Intermittent Lockups

1. Check cable connections and length.
2. Increase delay between all commands to 100 ms to make sure instrument is not being overloaded.
3. Ensure that the USB cable is not unplugged and that the teslameter is not powered down while the com port is open. The USB driver creates a com port when the USB connection is detected, and removes the com port when the USB connection is no longer detected. Removing the com port while in use by software can cause the software to lock up or crash.

6.4 Line Voltage

The F71/F41 teslameter will operate between the range of 100 VAC to 240 VAC, 50 Hz or 60 Hz configurations so that it can be operated from line power anywhere in the world. No manual switches need to be configured for different voltage operations.

6.5 Error and Status Messages

The following are error and status messages that may be displayed by the teslameter during operation.

	Message	Description
Instrument hardware error messages	EEPROM read error	The instrument failed to read a connected EEPROM. If this problem is not resolved by disconnecting and reconnecting the probe, it may indicate a defective EEPROM.
	Current source rail	The current does not have a path through the Hall sensor. The probe may have a mechanical fault that breaks the conducting path.
	Temperature compensation rail	The current does not have a path through the temperature sensor. The probe may have a mechanical fault that breaks the conducting path.
Measurement messages	No probe	There is no probe attached or the attached probe is damaged.
	Invalid probe	The detected probe does not contain calibration information. This is more often the case when using a Hall sensor.
	Incompatible probe	A previous generation probe has been attached that is not supported.
SCPI command error messages	Overload	The measured field is larger than the range. Increase the measurement range or turn autorange on. If error condition still exists, the probe may be damaged.
	ExecutionError	General execution error. Also occurs when attempting to execute multiple overlapping commands that use the same pattern simultaneously.
	ParameterError	General parameter error.
	IllegalParameter-Value	Parameter has an invalid value, such as being out of range.
	HardwareMissing	Required hardware, such as a probe, is missing.
	DataQuestionable	Data quality may be compromised. For example, when data is queried during a range change.
	HardwareError	Error reading probe EEPROM, Probe is not supported, or temperature compensation is railing.
	StorageFault	No data is found on the breakout adapter.
	DataOutOfRange	Data queried during an overload state.
	QueryError	Data queried on a channel that is disabled. AC-related values queried while in DC mode.
	SettingsConflict	Conflicting settings, such as enabling cryogenic mode while using a previous generation probe that does not support it.
SystemError	General error when attempting to parse the command/query.	

TABLE 6-1 F71/F41 teslameter error messages

6.6 System Troubleshooting

6.6.1 Factory Reset

For reset functions, please see section 3.5.13.

6.6.2 Calibration Procedure

Instrument calibration can be obtained through Lake Shore Service. Refer to section 6.9 for technical inquiries and contact information.

6.7 Rear Panel Connector Definitions

This section describes the rear panel connections.

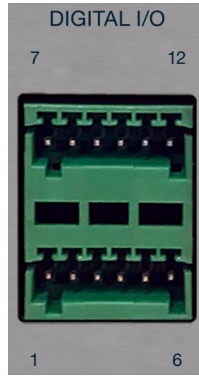

FIGURE 6-1 Digital I/O port

Pin	Description	Pin	Description
1	Ground	7	Ground
2	Power	8	Power
3	Input 2 low	9	Relay 2 low
4	Input 2 high	10	Relay 2 high
5	Input 1 low	11	Relay 1 low
6	Input 1 high	12	Relay 1 high

TABLE 6-2 Digital I/O pinouts

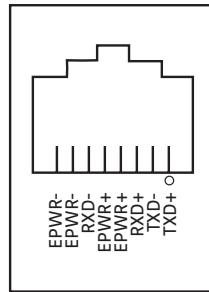

FIGURE 6-2 Ethernet pin and connector

Pin	Symbol	Description
1	TXD+	Transmit data+
2	TXD-	Transmit data-
3	RXD+	Receive data+
4	EPWR+	Power from switch+ (not used)
5	EPWR+	Power from switch+ (not used)
6	RXD-	Receive data-
7	EPWR-	Power from switch- (not used)
8	EPWR-	Power from switch- (not used)

TABLE 6-3 Ethernet pin and connector details

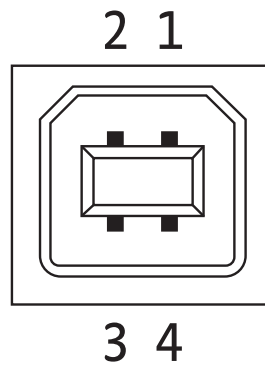

FIGURE 6-3 USB pin and connector

Pin	Symbol	Description
1	VCC	+5 VDC
2	D-	Data-
3	D+	Data+
4	GND	Ground

TABLE 6-4 USB pin and connector details

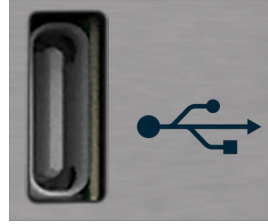

FIGURE 6-4 USB Type-C™ connector

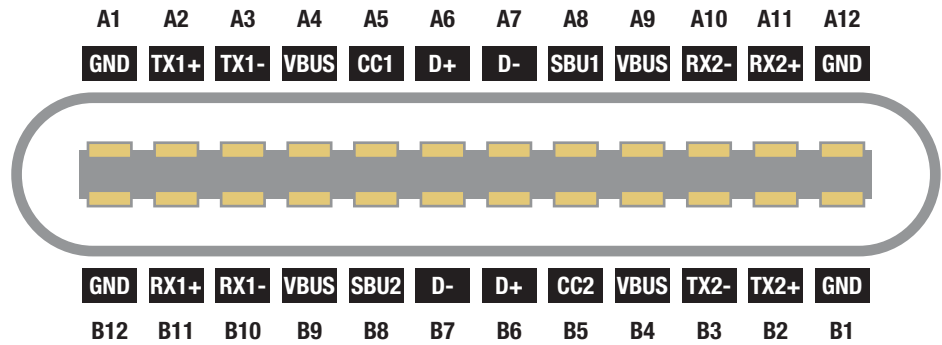

FIGURE 6-5 USB Type-C™ connector

Pin	Name	Description	Pin	Name	Description
A1	GND	Ground return	B12	GND	Ground return
A2	SSTXp1	SuperSpeed differential pair #1, TX, positive	B11	SSRXp1	SuperSpeed differential pair #2, RX, positive
A3	SSTXn1	SuperSpeed differential pair #1, TX, negative	B10	SSRXn1	SuperSpeed differential pair #2, RX, negative
A4	V _{BUS}	Bus power	B9	V _{BUS}	Bus power
A5	CC1	Configuration channel	B8	SBU2	Sideband use (SBU)
A6	Dp1	Non-SuperSpeed differential pair, position 1, positive	B7	Dn2	Non-SuperSpeed differential pair, position 2, negative
A7	Dn1	Non-SuperSpeed differential pair, position 1, negative	B6	Dp2	Non-SuperSpeed differential pair, position 2, positive
A8	SBU1	Sideband use (SBU)	B5	CC2	Configuration channel
A9	V _{BUS}	Bus power	B4	V _{BUS}	Bus power
A10	SSRXn2	SuperSpeed differential pair #4, RX, negative	B3	SSTXn2	SuperSpeed differential pair #3 TX, negative
A11	SSRXp2	SuperSpeed differential pair #4, RX, positive	B2	SSTXp2	SuperSpeed differential pair #3 TX, positive
A12	GND	Ground return	B1	GND	Ground return

TABLE 6-5 Digital I/O pinouts

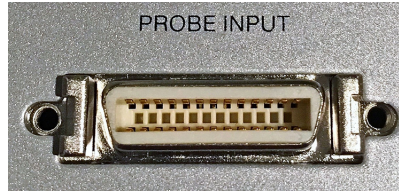

FIGURE 6-6 Probe input connector

Pin	Description	Pin	Description	Pin	Description
1	X1	10	Z3	19	EEPROM-CLK
2	X3	11	Z2	20	Temperature current
3	X2	12	Z4	21	EEPROM-Ground
4	X4	13	Shield	22	Temperature voltage +
5	Y1	14	Adapter-Detect	23	EEPROM-Power
6	Y3	15	Connector-Detect2	24	Temperature voltage -
7	Y2	16	Ground	25	Connector-Detect
8	Y4	17	EEPROM-Data	26	Ground
9	Z1	18	Temperature current +		

TABLE 6-6 Probe input connector details

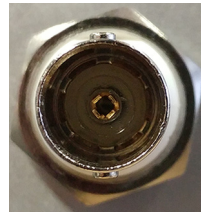

FIGURE 6-7 BNC analog output connector

Pin	Description
Center conductor	Output high
Outer shield	Output low (instrumentation ground)

TABLE 6-7 BNC analog output connector

6.8 Summary of Internal Memory Devices

This section outlines the internal memory devices used inside the F71/F41 teslameter, and provides an explanation of the types of data they contain.

Printed circuit board	Manufacturer	Part number	Description	Location	Function	Volatility	Field modifiable
Analog	Atmel/Microchip	ATSAME70Q21A	Microprocessor	U1	Microprocessor code	Non-volatile	No
Analog	Cypress	FM24V10	1 Mbit serial F-RAM	U2	Calibration data, license files	Non-volatile	No
Digital	Kingston	EMMC04G-S100-A08U	4 GB eMMC Flash	U31	Operating system, firmware repository, app service, and instrument settings	Non-volatile	No
Digital	SK Hynix	H5TC2G83GFR--PBA	1 GB (256 MB x 4) DDR3L SRAM	U2, U3, U4, U5	Run-time data storage	Volatile	No
Digital	Microchip	SST25VF016B-50-4C	16 Mbit serial flash	U17	Bootloader	Non-volatile	No
Field control option	Cypress	FM24V10	1 Mbit serial F-RAM	U16	Serial number, calibration data	Non-volatile	No
Probe connector	Microchip	24LC1025T-I/SN	1 Mb serial EEPROM	U1	Storing sensor calibration data	Non-volatile	Yes

TABLE 6-8 Internal memory devices

1. The Atmel/Microchip ATSAME70Q21A is a microprocessor with 2048 KB of onboard programmable flash memory. The code is loaded by initiating a firm-ware update over the remote interface.
2. The Cypress FM24V10 is a 128 KB I2C FRAM. It is used to store calibration constants and feature license files. The memory is programmed at Lake Shore.
3. The Kingston EMMC04G-S100-A08U is a 4GB eMMC flash memory used to store the instrument operating system. It also contains the local firmware repository and app service, and instrument settings. Presently the instrument settings stored in this memory are not resettable in the field, but will be in a future firm-ware update.
4. The SK Hynix H5TC2G63GFR-PBA memories are comprised of four 256 MBDDR3L SRAM chips, totaling 1 GB of volatile memory. This memory is used by the operat-ing system and applications during runtime as temporary data storage. Data is lost on a power cycle.
5. The Microchip SST25VF016B-50-4C is a 16 Mbit SPI flash. It is used to store boot-loader firmware. The memory is programmed at Lake Shore.
6. The Cypress FM24V10 is a 128 KB I2C F-RAM. It is used on the field control option card to store the serial number and calibration information. The memory is pro-grammed at Lake Shore.
7. The 24LC1025T is a 1 Mb I2C EEPROM. It is used to store probe information, serial number, and calibration data. In the majority of cases this information is pro-grammed by Lake Shore. However some customers may use modified or custom calibration curves.

6.9 Technical Inquiries

Refer to the following sections when contacting Lake Shore for application assistance or product service. Questions regarding product applications, price, availability and shipments should be directed to sales. Questions regarding instrument calibration or repair should be directed to instrument service. Do not return a product to Lake Shore without a Return Material Authorization (RMA) number (section 6.9.3).

6.9.1 Contacting Lake Shore

The Lake Shore Technical Support Department is staffed Monday through Friday between the hours of 8:00 AM and 5:00 PM EST, excluding holidays and company shut down days.

The Lake Shore Forum is also a great place to look for solutions, to post issues, and to share successes: <https://forums.lakeshore.com/>.

Contact Lake Shore Technical Support through any of the means listed below. However, the most direct and efficient means of contacting is to complete the online service request form at <https://www.lakeshore.com/support/>. Provide a detailed description of the problem and the required contact information. You will receive a response within 24 hours or the next business day in the event of weekends or holidays.

Mailing address	Lake Shore Cryotronics Support Departmentt 575 McCorkle Blvd. Westerville, Ohio USA 43082-8888	
E-mail address	sales@lakeshore.com support@lakeshore.com	Sales Support
Telephone	614-891-2244 614-891-2243, select the option for Support	Sales Support
Fax	614-818-1600 614-818-1609	Sales Support
Web service request	https://www.lakeshore.com/support/	Support

TABLE 6-9 Contact information

6.9.2 Return of Equipment

The teslameter is packaged to protect it during shipment.



The user should retain any shipping carton(s) in which equipment is originally received, in the event that any equipment needs to be returned.

If original packaging is not available, a minimum of 76.2 mm (3 in) of shock absorbent packing material should be placed snugly on all sides of the instrument in a sturdy corrugated cardboard box. Please use reasonable care when removing the teslameter from its protective packaging and inspect it carefully for damage. If it shows any sign of damage, please file a claim with the carrier immediately. Do not destroy the shipping container; it will be required by the carrier as evidence to support claims. Call Lake Shore for return and repair instructions.

All equipment returns must be approved by a member of the Lake Shore Service Department. The service engineer will use the information provided in the service request form and will issue an RMA. This number is necessary for all returned equipment. It must be clearly indicated on both the shipping carton(s) and any correspondence relating to the shipment. Once the RMA has been approved, you will receive appropriate documents and instructions for shipping the equipment to Lake Shore.

6.9.3 RMA Valid Period

RMAs are valid for 60 days from issuance; however, we suggest that equipment needing repair be shipped to Lake Shore within 30 days after the RMA has been issued. You will be contacted if we do not receive the equipment within 30 days after the RMA is issued. The RMA will be cancelled if we do not receive the equipment after 60 days.

6.9.4 Shipping Charges

All shipments to Lake Shore are to be made prepaid by the customer. Equipment serviced under warranty will be returned prepaid by Lake Shore. Equipment serviced out-of-warranty will be returned FOB Lake Shore.

6.9.5 Restocking Fee

Lake Shore reserves the right to charge a restocking fee for items returned for exchange or reimbursement.