

Measure Ready

M81 SSM

**Beyond the lock-in.
Beyond the SMU.**

Eight instruments. One system. Zero compromises.



AC current source DC current source Precision ammeter Lock-in amplifier
AC voltage source DC voltage source Precision voltmeter SMU

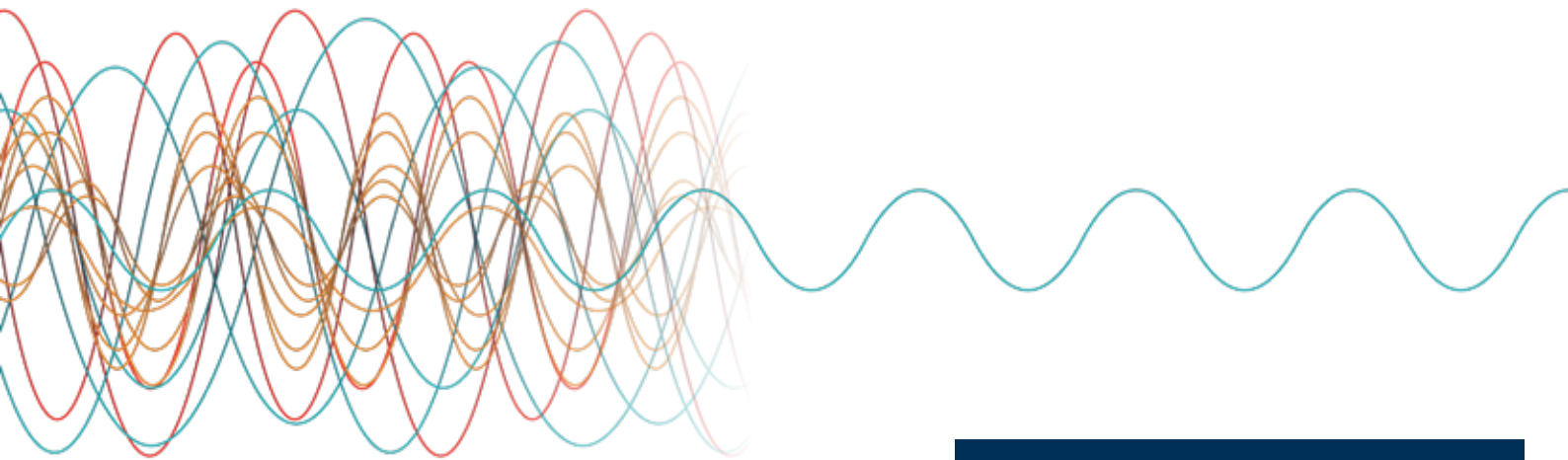

BEYOND THE LOCK-IN.

For materials researchers who demand more
—synchronized, low-noise measurements that separate instruments can't deliver.

- ✓ *>120 dB dynamic reserve*
- ✓ *<0.0001° RMS phase noise*
- ✓ *True differential I-V source + measure*
- ✓ *Up to 3 source + 3 measure channels*
- ✓ *DC+AC to 100 kHz*

DC+AC voltage source: 10 nV to 10 V, low noise (350 nV RMS) 100 μ Hz to 100 kHz

DC+AC current source: 10 nA to 100 mA, 150 fA RMS (750 fA peak-to-peak) / 100 μ Hz to 100 kHz

Precision ammeter: Combined AC lock-in with DC, <100 fA sensitivity

Precision voltmeter: Combined AC lock-in with DC, <10 fA sensitivity



BEYOND THE SMU.

For device engineers who need world-class DC precision plus the AC and lock-in capabilities next-generation devices demand.

- ✓ 10 to 100× lower source noise than typical DC SMUs
- ✓ <100 fA DC sensitivity
- ✓ Lock-in voltage sensitivity in a DC+AC SMU format

- 10 to 100× lower source noise than typical SMUs
- <10 nV/<6 fA sensitivity at 1 kHz
- <100 fA DC accuracy across ±10 V
- Fast sampling for rapid I-V curves
- Single guarded triaxial port simplifies setup

Select probe stations now include an M81-SSM with SMU-10 at no extra cost



BEYOND THE LOCK-IN.

The M81-SSM is purpose-built for the demands of materials characterization, where sensitivity, synchronization, and low noise aren't optional.

Materials research demands the most sensitive electrical measurements possible. Detecting transport properties in novel semiconductors, characterizing magnetic materials, measuring resistance through phase transitions—these measurements push instruments to their limits.

For decades, the lock-in amplifier has been the cornerstone of sensitive materials measurement. But modern research demands more: simultaneous DC and AC measurements, synchronized multi-parameter data, and noise floors low enough to resolve signals in the most challenging samples.

Traditional approaches mean assembling instruments from different vendors, each with its own clock, ground reference, and noise signature. Ground loops. Timing errors. Compounded noise. Never designed to work together. **The M81-SSM is.**

The M81's lock-in rivals the best standalone instruments ($<0.0001^\circ$ RMS phase noise, >120 dB dynamic reserve) pulling signals from noise that would overwhelm conventional setups. Purpose-built modules, synchronized through a common timebase and unified noise architecture. Designed and optimized for measurements that separate instruments can't deliver.



The M81-SSM doesn't just replace your instrument rack. It outperforms it, because it was designed as one integrated source/measure system.

Key capabilities for materials research:

- Lock-in detection to nanovolt sensitivity
- $<0.0001^\circ$ RMS phase noise across channels
- 375 kSa/s synchronized sampling
- Combined DC + AC measurements from a single unified system
- Eliminates ground loops, timing errors, and inter-instrument noise compounding
- Configurable for transport, Hall, impedance, and low-level I-V measurements

DC voltage source	100 nV to 10 V, low noise (350 nV RMS)
AC voltage source	100 μ Hz to 100 kHz, low noise (40 nV/ $\sqrt{\text{Hz}}$ at 1 kHz)
DC current source	10 nA to 100 mA, 150 fA RMS (750 fA peak-to-peak)
AC current source	100 μ Hz to 100 kHz, 20 fA/ $\sqrt{\text{Hz}}$ at 10 Hz
Precision voltmeter	Combined AC lock-in with DC component, <10 fA sensitivity
Precision ammeter	Combined AC lock-in with DC component, <100 fA sensitivity
Lock-in amplifier	$<0.0001^\circ$ RMS phase noise, >120 dB dynamic reserve



Purpose-built modules for ultra-low noise and sensitivity, ready for the most demanding samples.

VS-10 – Voltage Source



The VS-10 provides programmable voltage from ± 1 V to ± 10 V with a maximum of 100 mHz compliance, up to 100 kHz. Purpose-built for gate-biasing, voltage-sweep I-V curves, applications requiring highly stable voltages in combination with current, resistance, conductance, and other material or device measurements.

- 100 nV to 10 V, low noise (350 nV RMS)
- Patented dual AC+DC range for seamless sourcing

BCS-10 – Balanced Current Source



The BCS-10 provides programmable currents from 1 pA to 100 mA with a maximum of 30 V compliance, up to 100 kHz. Its design reduces noise and improves common-mode rejection – delivering source noise performance that significantly improves measurement quality in sensitive applications.

- 10 nA to 100 mA, 150 fA RMS (750 fA peak-to-peak)
- DC to 100 kHz with or without AC modulation

VM-10 – Precision Voltage Measurement



The VM-10 provides voltage measurements with resolution from nanovolts to millivolts, with AC lock-in and DC measurement capabilities. Very useful for applications requiring numerous range changes including amplitude, phase, and harmonic detection.

- Combined AC lock-in with DC component
- < 10 fA sensitivity
- Configurable next to or remote from the M81 instrument for minimum environmental noise pickup

CM-10 – Precision Current Measurement



The CM-10 provides current measurements with near-zero input offset voltage from nanoamps to 100 nA, including amplitude, phase, and harmonic detection capabilities. Can be paired with the VM-10 module for combined voltage and current measurements.

- Combined AC lock-in with DC component
- <100 fA sensitivity
- Programmable ± 1 V voltage bias offset for applications requiring biased current measurements

BEYOND THE SMU.

When materials become devices, the M81-SSM and SMU-10 are ready — world-class DC precision with the AC and lock-in capabilities next-generation devices demand.

The path from materials research to device development is a critical transition. Where materials researchers need lock-in sensitivity and synchronized multi-parameter measurements, device engineers need something different: the familiar source-measure workflow of the SMU, with the precision to characterize devices at nanometer scales.

Traditional SMUs excel at DC source-measure. But as devices shrink to atomically thin dimensions, DC-only instruments reach their limits. Ultra-low leakage currents, weak AC signals buried in noise, frequency-dependent behaviors — these demand capabilities that conventional SMUs simply weren't designed to provide.

The SMU-10 module for the M81-SSM was designed specifically for this transition. It delivers world-class DC accuracy on par with the best DC-only SMUs — then goes further, adding AC sourcing to 100 kHz and lock-in sensitivity for signals buried deep in noise. All in the familiar four-quadrant SMU format device engineers already know.

The same M81 integration advantage that makes it the ideal materials research platform makes it equally powerful for device characterization: synchronized measurements, unified noise architecture, and a signal path designed and optimized for low-level measurements.

Key capabilities for device research:

- DC accuracy on par with the world's best DC-only SMU
- 10 to 100× lower source noise than typical DC SMUs
- AC sourcing and measurement to 100 kHz
- Lock-in detection for signals buried in noise
- Voltage or current-controlled I-V characterization from DC to 100 kHz
- Up to 3 synchronized SMU-10 modules for correlated device measurements



The SMU-10 enables I-V characterization of nanometer-scaled and atomically thin devices using voltage or current control — from DC to 100 kHz, with or without AC modulation.



Three SMU-10 modules can be used with a single M81-SSM instrument, offering synchronized I-V characterization of atomic-scale devices.

DC versatility meets AC lock-in sensitivity, purpose-built for next-generation semiconductor characterization.

Characterizing atomically thin and nanoscale semiconductors demands capabilities traditional DC SMUs simply can't provide. The SMU-10 delivers world-class DC accuracy for precise I-V characterization, dramatically lower source noise than conventional SMUs, and the AC sensitivity of dedicated lock-in amplifiers, all in the familiar four-quadrant SMU format device engineers know.

It's a microcosm of the M81 philosophy: designed and optimized for capabilities that separate instruments can't deliver.

Key capabilities for device research:

- 10 to 100× lower source noise than typical DC SMUs
- <10 nV/<6 fA AC sensitivity at 1 kHz
- <100 fA DC accuracy across ±10 V output
- Fast sampling for rapid DC and AC I-V curve acquisition
- Single guarded triaxial port for simplified four-quadrant source/measure
- Up to 3 synchronized SMU-10 modules in an M81 system

SMU-10 – Source Measure Unit



The SMU-10 combines world-class DC accuracy with AC sourcing and lock-in sensitivity in the familiar four-quadrant SMU format. Purpose-built for atomically thin and nanoscale semiconductor characterization.

- 10 to 100× lower source noise than typical DC SMUs
- DC to 100 kHz with or without AC modulation
- Up to 3 synchronized SMU-10 modules for one M81-SSM

Four functions. One module.

	Ultra-low DC capabilities	DC and AC capabilities	Integrated lock-in
DC current	Offset <100 fA	Sine	—
AC current	—	Triangle/square to 5 kHz, sine up to 100 kHz	<6 fA sensitivity
DC voltage	Microvolt sensitivity	Sine	—
AC voltage	—	Triangle/square to 5 kHz, sine up to 100 kHz	<10 nV sensitivity

*on 1 mA range and up

EIGHT INSTRUMENTS. ONE SYSTEM.

Everything you need for sensitive I-V measurements

— integrated, synchronized, and optimized in one unified system.

A complete materials or device characterization setup has traditionally meant assembling multiple instruments from multiple vendors (DC sources, AC sources, lock-in amplifiers, precision meters, SMUs) each with its own clock, its own ground reference, and its own noise signature. The result is a rack full of instruments that were designed separately and required time and patience, to get them to work together.

The M81-SSM replaces all of it. Eight instruments, unified in one synchronized system — each architecturally optimized, all sharing a common timebase and noise architecture that eliminates the compounding errors of multi-vendor setups.

DC voltage source	100 nV to 10 V, low noise (350 nV RMS)
AC voltage source	100 μ Hz to 100 kHz, low noise (40 nV/ $\sqrt{\text{Hz}}$ at 1 kHz)
DC current source	10 nA to 100 mA, 150 fA RMS (750 fA peak-to-peak)
AC current source	100 μ Hz to 100 kHz, 20 fA/ $\sqrt{\text{Hz}}$ at 10 Hz
Precision voltmeter	Combined AC lock-in with DC component, <10 fA sensitivity
Precision ammeter	Combined AC lock-in with DC component, <100 fA sensitivity
Lock-in amplifier	<0.0001° RMS phase noise, >120 dB dynamic reserve
Source measure unit (SMU)	World class DC accuracy with AC capabilities and lock-in

COMPONENTS OF THE M81-SSM SYSTEM

- Connect up to three source modules and up to three measure modules
- Exchange modules and adapt the configuration for each measurement
- All modules are capable of measuring with DC and AC to 100 kHz
- All modules are optimized for highest precision with common amplitude and frequency references

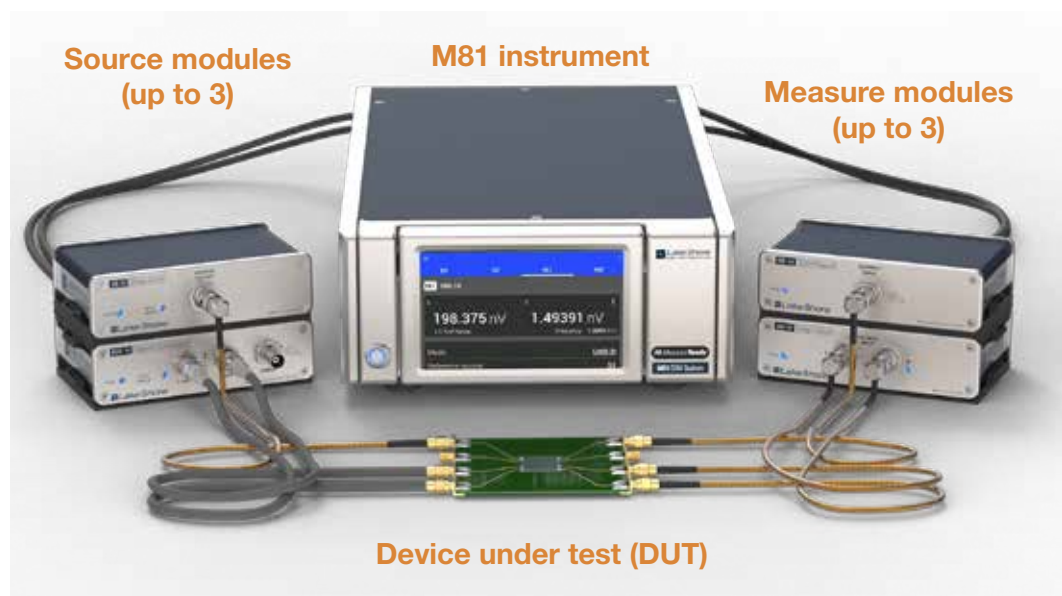

MODULES USING PATENTED SIGNAL TECHNOLOGY

The M81-SSM system provides DC to 100 kHz precision electrical source and measure capabilities with 375 kHz (2.67 μ s) source/measure digitization rates across up to 3 source and 3 measurement front-end modules.

All modules are designed with linear circuitry powered by highly isolated linear power supply designs for the lowest possible voltage/current noise performance, rivaling modern lock-in amplifiers and research lab-grade source and measure instruments.

These quick-swappable modules with embedded calibration data enable quick measurement reconfiguration during and between experimental setups. Compact and well shielded, the modules can be remote, rack, or benchtop mounted depending on application requirements and user preference. For interconnection to the main instrument, the modules come standard with 2 m cables, but you can also order optional 8 m extender cables for making connections up to 10 m in length.

Built-in patented capabilities include:

- Patented† dual AC and DC range sourcing allowing for precise, full control of DC and AC amplitude signals with a single module and sample/device connection (VS-10 module)
- Patented†† seamless range change measuring – for significantly reducing or eliminating the typical range change-induced measurement discontinuities in signal sweeping applications that require numerous range changes (VM-10 module)

The integration of both AC and DC into single source and measurement modules:

- Simplifies connections to the device under test
- Simplifies ground return connection schemes
- Simplifies test programming by allowing DC and AC signals to be sourced and measured under program control and without changing hardware or connections
- Enables AC modulation with a DC bias and allows a high degree of signal flexibility and measurement resolution options

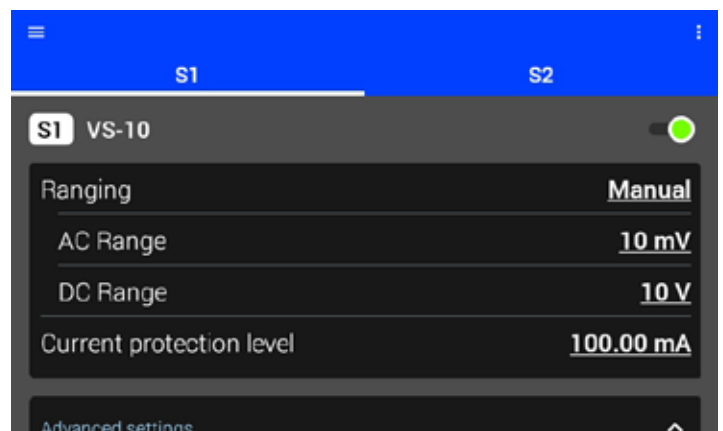

Dual AC and DC range source settings on the VS-10 module enable better control of DC and AC amplitude signals

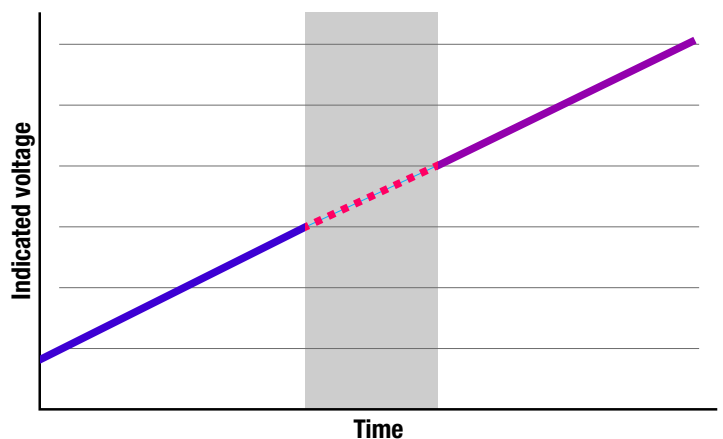

- Signal on range 1
- Signal on range 2
- ▨ M81 provides continuously observed signal
- Measurements lost during typical instrument range change

Seamless range change measuring is provided with the VM-10 module, as demonstrated by this voltage vs. time sweep.

† Protected by US patent number 11959991-B2. Other patents pending.

†† Protected by US patent number 11982730-B2. Other patents pending.

Timing is everything.

Now it's automatic.

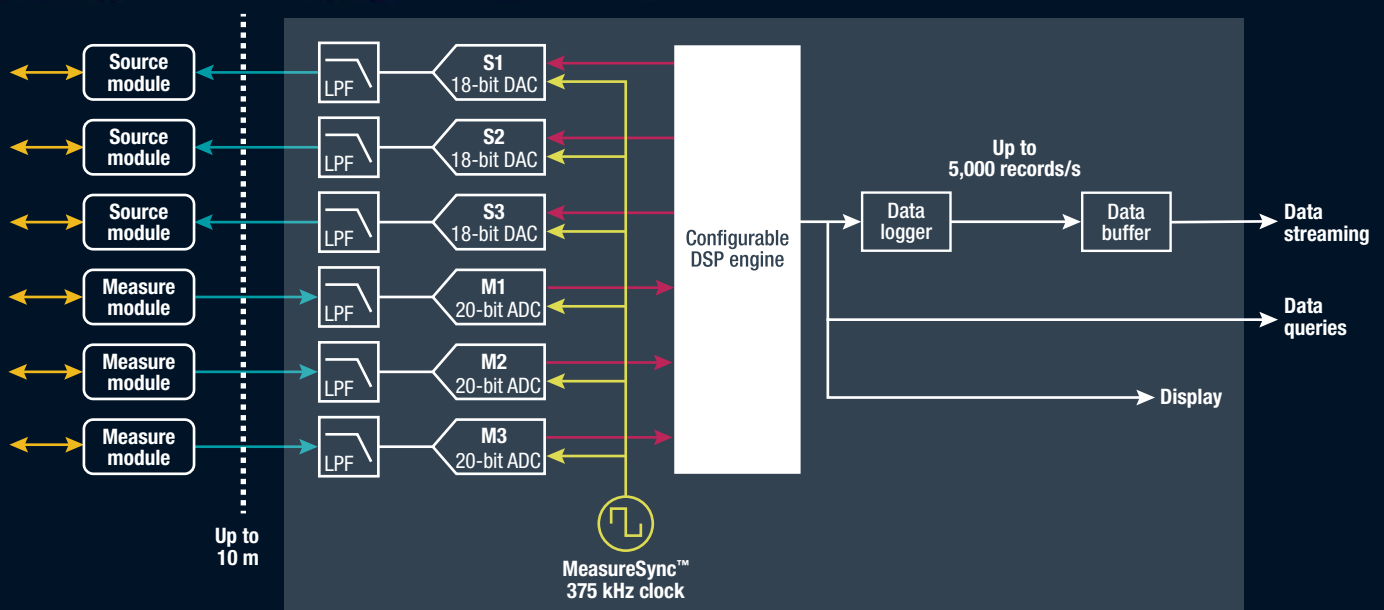

MeasureSync architecture allows for tightly synchronized data collection from the remotely located modules. Amplitude and frequency signals are transmitted to/from the remote amplifier modules using a proprietary, real-time analog voltage method that minimizes noise and ground errors while ensuring tight synchronization of all modules. This analog interface keeps noisy digital circuitry away from the modules' sensitive analog circuits. The signals are digitized by a dedicated converter for each channel, which are synchronized by the shared MeasureSync clock. Each rising edge of the clock triggers every ADC to take a reading and triggers each DAC to update its output. In between clock edges, all of the data is transferred from ADCs to the controller and each DAC is preloaded with a value that is applied on the next edge. Unlike multiplexed systems, this maintains total synchronization and continuous sampling of each channel. Digital signals are generated or processed by a configurable DSP core.

Each measure channel can be configured to perform DC, AC, or lock-in measurements. The core processes the individual readings collected at 375 kSa/s and produces fully processed and calibrated readings at up to 5 kSa/s. These readings can be observed on the front panel and collected via the remote interface.

The multiple parameter query structure allows a single data query to return multiple readings in one query, which maintains synchronization. Additionally, the configurable data streaming interface can be used to provide a continuous stream of synchronized data at a fixed, regular time interval, or a burst of high-speed collection. This combination of an analog interface to the distributed modules, a centralized simultaneous acquisition clock, and a unified remote interface provides end-to-end signal synchronization that cannot be easily achieved with separate instrumentation.

AS EASY TO USE AS YOUR SMARTPHONE

The M81 instrument front display has an easy independent setup of each module's output or input parameters, including range, amplitudes, frequencies, and filters. Each module has a full screen of controls on the M81, similar to the VM-10 screen shown here. The output settings or measure input data of each module are easy to manipulate (S1, S2, S3, M1, M2, or M3). The result is an easy setup to make and see measurement results. To collect several measurements over time as a source is ramped or an environment parameter is changed like temperature or field, Lake Shore created MeasureLINK software to control environmental or source parameters over time and capture the measurement data.



Each screen is easily scrolled up and down to change parameters for whichever module you have selected

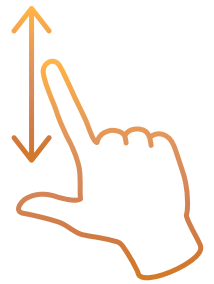

Made for the way you work today, the M81 features an uncluttered touch display with a unique TiltView™ screen, presenting a natural and engaging user interface.

With no confusing buttons or long learning curves, the M81 is intuitive and straightforward to operate. You'll quickly recognize the icons, gestures, and menu styles that follow familiar smartphone technology standards.

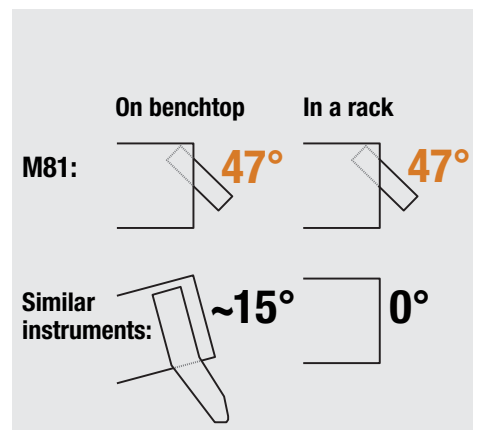

THE M81 INSTRUMENT—THE HEART OF THE SYSTEM

The heart of the M81-SSM is the instrument. Depending on the model ordered, the instrument supports a total of 2, 4, or 6 channels comprising 1, 2, or 3 sources and 1, 2, or 3 measures, respectively, as shown here:

Instrument model	Maximum channel capacity	Number of source channels	Number of measure channels
M81-SSM-2	2	1	1
M81-SSM-4	4	2	2
M81-SSM-6	6	3	3

Each M81 instrument can manage from 1 to 3 source channels and from 1 to 3 measure channels per half-rack for testing of multiple DUTs during a single test sequence without adding complexity and signal degradation from signal switching.

More than one instrument can also be combined to increase source and measure channel capabilities without degradation of analog performance while utilizing MeasureSync™ timing synchronization across all signal channels within the system.

Built on the Lake Shore MeasureReady™ instrument platform, the instrument features a graphical, touchscreen interface for both programming control and monitoring. Its ergonomically designed front panel features a TiltView™ display for best visibility, whether on a bench or mounted in a rack. It also supports standard LAN, USB, and GPIB communications.



MeasureReady M81 rear panel

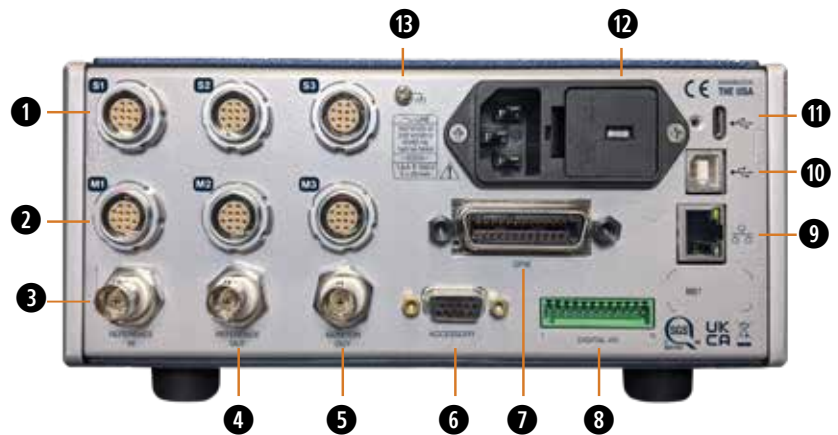

- ❶ LEMO source module connectors
- ❷ LEMO measure module connectors
- ❸ BNC reference input
- ❹ BNC reference output
- ❺ BNC monitor output
- ❻ DB15 accessory connector
- ❼ GPIB interface connector
- ❽ 12-pin digital I/O connector
- ❾ RJ-45 Ethernet interface
- ❿ USB communications interface
- ⓫ USB Type-C™ thumb drive interface
- ⓬ AC mains input connector and voltage selector/fuse module
- ⓭ Chassis ground connection

M81 instrument specifications

Specifications are subject to change

Source channels

Source channel functions	DC: triangle/square (up to 5 kHz), sine (up to 100 kHz)
Source sync functions	Synchronize to another channel or internal or external reference in
Frequency range	100 μ Hz to 100 kHz (or module bandwidth, whichever is lesser)
Frequency resolution	Greater of 100 μ Hz, 6 digits
Frequency accuracy	0.06%
Phase noise	100 ms time constant, 12 dB/oct: Internal reference: <0.0001° RMS at 10 kHz External reference: <0.002° RMS at 10 kHz
Dynamic reserve	>120 dB (typical, see manual)

Measure channels

Measure channel functions	DC, AC (RMS, peak), or lock-in (X and Y, R and Θ)
Lock-in reference	Any source channel, or external reference input
Reference in	BNC: sine ≥ 1 V p – p ≥ 200 Hz; square ≥ 1 V p – p ≥ 10 mHz
Reference out	BNC: 3.3 V square
Monitor out	BNC: M1 monitor, M2 monitor, M3 monitor, manual output
Digital inputs	6-pin 3.5 mm detachable terminal block: 2 TTL compatible inputs: V_{high} nominal: 3.3 V; V_{low} nominal: 0 V
Digital outputs	6-pin 3.5 mm detachable terminal block: 2 TTL compatible outputs: 3.3 V_{high} nominal at 1 mA
Total harmonic distortion	<0.1% from DC to 100 kHz, typical
Sample rate	375 kSa/s
Warm-up time	60 min to achieve specified accuracy
Isolation	Measure common isolated from chassis ground
Front panel display	5 in capacitive touch, color TFT-LCD WVGA (800 \times 480) with LED back-light

System speeds

	USB	GPIB	Ethernet
Data streaming maximum reading rate (records/s)	5000	5000	5000
Data streaming maximum data throughput ¹ (kB/s)	20	40	80
Typical SCPI query response time ² (ms)	15	20	60

¹ Host PC dependent; speeds measured using PyVISA and Python 3 on Windows® 10 Intel® Core™ i7-8700 2.4-GHz CPU PC with 16 GB RAM

² 99% of queries are serviced faster than this interval

Interface

IEEE-488.2 (GPIB)

Function	IEEE-488 command and control
Capabilities	SH1, AH1, T5, L4, SR1, RL1, PPO, DC1, DT0, CO, E1
Data throughput	Limited by 3 megabit internal bus rate

Connector	IEEE-488 24-pin receptacle with M3.5 jack screws
Software support	LabVIEW™, Python, MeasureLINK, IVI.NET

USB host

Type	USB 3.0 MSC device
Function	Firmware updates, flash drive support
Connector	USB Type-C™

USB device

Type	USB 2.0
Function	Emulates a standard RS-232 serial port
Protocol	Standard commands for programmable instruments (SCPI)
Baud rate	921 600 Bd
Connector	USB Type-B
Software support	LabVIEW, Python, MeasureLINK, IVI.NET

Ethernet

Function	TCP/IP command and control
App layer protocol	Standard commands for programmable instruments (SCPI)
Connector	RJ-45
Speed	1 Gb/s
Software support	LabVIEW, Python, MeasureLINK, IVI.NET

General

Ambient temperature	Rated accuracy ± 5 °C of calibration temperature; 5 °C to 40 °C at reduced accuracy
Power requirement	100 V, 120 V, 220 V, 240 V, $\pm 10\%$, 50 or 60 Hz, 140 VA
Size	216 mm W \times 87 mm H \times 369 mm D (8.5 in \times 3.4 in \times 14.5 in), half rack
Weight	5.7 kg (12.6 lb)
Approvals	NRTL (UL/CSA), CE, RoHS

Available BNC adapter specifications

When used with S1, S2, or S3 source connections

Range	10 V, fixed
Noise	<1 μ V/ \sqrt Hz at 1 kHz
Output impedance	25 Ω
Raw converter resolution	18 bits (76 μ V/LSB)
Temperature coefficient	50 ppm/°C
Accuracy (typical)	0.25% + 1 mV (1 year, ± 5 °C from calibration temperature, after self calibration of instrument and within 24 h and ± 1 °C, no calibration applicable to the cable itself)

When used with M1, M2, or M3 measure connections

Range	10 V, fixed
Noise	<1 μ V/ \sqrt Hz at 1 kHz
Input impedance	10 M Ω
Raw converter resolution	20 bits (19 μ V/LSB)
Temperature coefficient	50 ppm/°C
Accuracy (typical)	0.25% + 1 mV (1 year, ± 5 °C from calibration temperature, after self calibration of instrument and within 24 h and ± 1 °C, no calibration applicable to the cable itself)

SMU-10 SOURCE MEASURE UNIT MODULE



The source measure unit (SMU-10) is the latest module addition to the MeasureReady™ M81-SSM synchronous source measure system. It is specifically designed to handle the delicate nature of nano and ultra-cold samples with exceptionally low source noise and high measurement sensitivity. The SMU-10 offers both DC and AC capabilities and an integrated lock-in, providing a comprehensive suite of measurements tailored to advanced research applications.

ULTRA-LOW NOISE	DC & AC CAPABILITIES	INTEGRATED LOCK-IN
----------------------------	-------------------------------------	-------------------------------

All-in-one precision tool

The SMU-10 integrates 6 instruments into a unified solution

Measurement	Measure	Source
DC current	Down to <100 fA	Up to 100 mA
DC voltage	Down to microvolts	Up to 10 V
AC current	Sine (up to 100 kHz), triangle (up to 5 kHz), square (up to 5 kHz)	
AC voltage	Sine (up to 100 kHz), triangle (up to 5 kHz), square (up to 5 kHz)	
Lock-in	Down to nanovolts	N/A
Resistance	Milliohms to 100 GΩ	

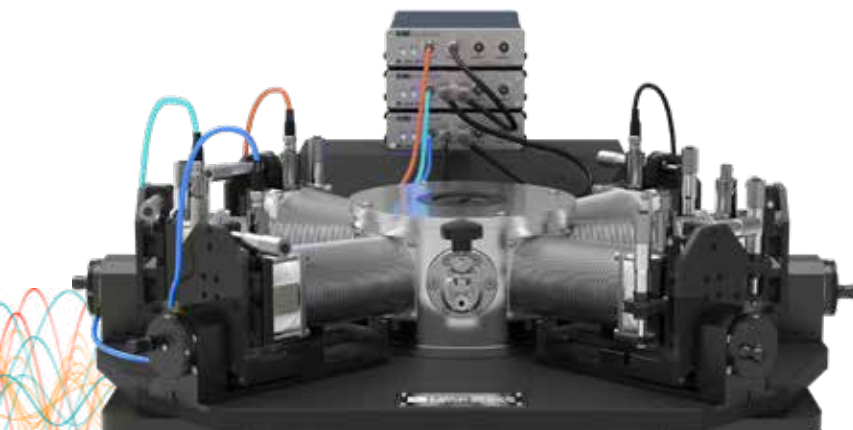

Three-terminal FET DC transfer curve

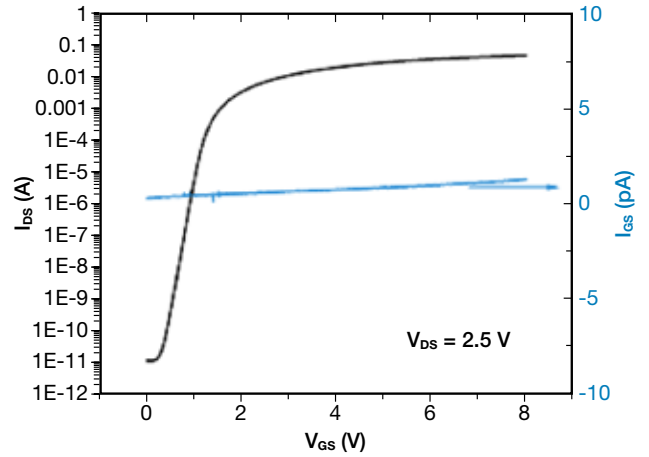

Source/measure

When testing multi-terminal devices in a cryogenic probe station, use the M81-SSM with SMU-10 modules to apply voltage or current to the DUT and measure the corresponding current or voltage. The SMU's topology reduces the number of probe arms by half, significantly minimizing thermal impact. Set compliance limits to protect the DUT from accidental overloads.

Advanced resistance

The M81-SSM's advanced resistance mode compensates for phase shifts caused by parasitic capacitance in cryogenic environments, ensuring more accurate resistance measurements. This technique reduces errors significantly, improving measurement accuracy.

Four-wire voltage monitoring

Ideal for high-current devices. The Sense-HI and Sense-LO leads enable 4-wire measurements for built-in device voltage monitoring while sourcing currents.

Synchronized sampling

Patented MeasureSync™ technology ensures perfect timing coordination for AC or DC measurements across multiple SMU-10 modules, eliminating data misalignment errors.

◀ *Minimize thermal impact by using SMU-10 modules with a probe station. In this example, the orange wire is the source, the light blue wire is the drain, the dark blue wire is the gate, and the black wire is the ground.*

SMU-10 specifications

Specifications are subject to change

Voltage	Current
Ranges: 10 mV, 100 mV, 1 V, 10 V Measure sensitivity: <3 nV ¹ Source noise (DC to 10 MHz): <0.2 mV RMS, <1.2 mV p-p (typical)	Ranges: 1 nA, 10 nA, 100 nA, 1 µA, 10 µA, 100 µA, 1 mA, 10 mA, 100 mA Measure sensitivity: <1 fA ¹ DC output resistance: >10 TΩ (typical) Source noise (DC to 10 MHz): <5 nA RMS, <25 nA p-p (typical)



SMU-10 front view

Overvoltage protection: ±200 VDC

Maximum power: 1 W, 4-quadrant operation

Magnetic field exposure: Operational up to 50 mT DC

Size: 142 mm (5.58 in) W × 38.9 mm (1.53 in) H × 245 mm (9.63 in) L

Noise

	Range	Source		Measure	
		0.1 Hz to 10 Hz	1 kHz	0.1 Hz to 10 Hz	1 kHz
Voltage noise (typical)	10 mV	250 nV RMS (1.25 µV p-p)	30 nV/√Hz	250 nV RMS (25 µV p-p)	30 nV/√Hz
	100 mV	300 nV RMS (1.5 µV p-p)	35 nV/√Hz	300 nV RMS (2.75 µV p-p)	30 nV/√Hz
	1 V	550 nV RMS (2.75 µV p-p)	35 nV/√Hz	550 nV RMS (1.5 µV p-p)	40 nV/√Hz
	10 V	5 µV RMS (25 µV p-p)	50 nV/√Hz	5 µV RMS (1.25 µV p-p)	180 nV/√Hz
Current noise (typical)	1 nA	100 fA RMS (500 fA p-p)	6 fA/√Hz (at 10 Hz)	15 fA RMS (75 fA p-p)	6 fA/√Hz (at 10 Hz)
	10 nA	100 fA RMS (500 fA p-p)	20 fA/√Hz (at 100 Hz)	45 fA RMS (225 fA p-p)	20 fA/√Hz (at 100 Hz)
	100 nA	300 fA RMS (1.5 pA p-p)	60 fA/√Hz (at 100 Hz)	175 fA RMS (875 fA p-p)	60 fA/√Hz (at 100 Hz)
	1 µA	1 pA RMS (5 pA p-p)	200 fA/√Hz	1 pA RMS (5 pA p-p)	200 fA/√Hz
	10 µA	5 pA RMS (25 pA p-p)	1 pA/√Hz	6 pA RMS (30 pA p-p)	1 pA/√Hz
	100 µA	50 pA RMS (250 pA p-p)	3 pA/√Hz	60 pA RMS (300 pA p-p)	2 pA/√Hz
	1 mA	500 pA RMS (2.5 nA p-p)	30 pA/√Hz	550 pA RMS (2.75 nA p-p)	20 pA/√Hz
	10 mA	5 nA RMS (25 nA p-p)	300 pA/√Hz	5.5 nA RMS (27.5 nA p-p)	200 pA/√Hz
	100 mA	50 nA RMS (250 nA p-p)	3 nA/√Hz	55 nA RMS (1.375 µA p-p)	2 nA/√Hz

¹ 10 s time constant, 24 dB roll-off

SMU-10 specifications

Accuracy

	Range	Source		Measure	
		DC ² ± (% rdg + offset)	Lock-in ^{2,3} ± (% rdg + offset)	DC ² ± (% rdg + offset)	Lock-in ^{2,3} ± (% rdg + offset)
Voltage accuracy	10 mV	0.15% + 300 µV	0.15% + 50 nV	0.15% + 300 µV	0.15% + 50 nV
	100 mV	0.1% + 300 µV	0.1% + 500 nV	0.1% + 300 µV	0.1% + 500 nV
	1 V	0.05% + 600 µV	0.05% + 5 µV	0.05% + 600 µV	0.05% + 5 µV
	10 V	0.05% + 2 mV	0.05% + 50 µV	0.05% + 2 mV	0.05% + 50 µV
Current accuracy	1 nA	0.6% + 100 fA + 5 fA/V	0.5% + 5 fA	0.6% + 100 fA + 5 fA/V	0.5% + 5 fA
	10 nA	0.6% + 300 fA + 50 fA/V	0.1% + 50 fA	0.6% + 300 fA + 50 fA/V	0.1% + 50 fA
	100 nA	0.3% + 50 pA + 0.5 pA/V	0.1% + 500 fA	0.3% + 50 pA + 0.5 pA/V	0.1% + 500 fA
	1 µA	0.1% + 300 pA + 5 pA/V	0.1% + 5 pA	0.1% + 300 pA + 5 pA/V	0.1% + 5 pA
	10 µA	0.1% + 3 nA + 0.05 nA/V	0.05% + 50 pA	0.1% + 3 nA + 0.05 nA/V	0.05% + 50 pA
	100 µA	0.1% + 30 nA + 0.5 nA/V	0.05% + 500 pA	0.1% + 30 nA + 0.5 nA/V	0.05% + 500 pA
	1 mA	0.05% + 300 nA + 5 nA/V	0.05% + 5 nA	0.05% + 300 nA + 5 nA/V	0.05% + 5 nA
	10 mA	0.05% + 3 µA + 0.05 µA/V	0.05% + 50 nA	0.05% + 3 µA + 0.05 µA/V	0.05% + 50 nA
100 mA	0.05% + 10 µA + 0.5 µA/V	0.05% + 500 nA	0.05% + 10 µA + 0.5 µA/V	0.05% + 500 nA	

Settable resolution

	Range	Source
Voltage settable resolution	10 mV	100 nV
	100 mV	1 µV
	1 V	10 µV
	10 V	100 µV
Current settable resolution	1 nA	10 fA
	10 nA	100 fA
	100 nA	1 pA
	1 µA	10 pA
	10 µA	100 pA
	100 µA	1 nA
	1 mA	10 nA
	10 mA	100 nA
100 mA	1 µA	

² Total system accuracy, 1 year and ±5 °C from Lake Shore calibration, 24 h and ±1 °C from self-calibration, 95% confidence

³ DC to 1 kHz or 10% of source range bandwidth, whichever is lower



SMU-10 specifications

Temperature coefficient

	Range	Source ^{2,3}	Measure ^{2,3}
		\pm (ppm rdg/ $^{\circ}$ C + offset/ $^{\circ}$ C)	\pm (% rdg + offset)
Voltage temperature coefficient	10 mV	25 ppm/ $^{\circ}$ C + 5 μ V/ $^{\circ}$ C	25 ppm/ $^{\circ}$ C + 20 μ V/ $^{\circ}$ C
	100 mV	5 ppm/ $^{\circ}$ C + 5 μ V/ $^{\circ}$ C	10 ppm/ $^{\circ}$ C + 20 μ V/ $^{\circ}$ C
	1 V	5 ppm/ $^{\circ}$ C + 5 μ V/ $^{\circ}$ C	6 ppm/ $^{\circ}$ C + 20 μ V/ $^{\circ}$ C
	10 V	5 ppm/ $^{\circ}$ C + 5 μ V/ $^{\circ}$ C	6 ppm/ $^{\circ}$ C + 100 μ V/ $^{\circ}$ C
Current temperature coefficient ^{1,2}	1 nA	5 ppm/ $^{\circ}$ C + 2 pA/ $^{\circ}$ C	5 ppm/ $^{\circ}$ C + 0.5 pA/ $^{\circ}$ C
	10 nA	5 ppm/ $^{\circ}$ C + 2 pA/ $^{\circ}$ C	5 ppm/ $^{\circ}$ C + 0.5 pA/ $^{\circ}$ C
	100 nA	5 ppm/ $^{\circ}$ C + 2 pA/ $^{\circ}$ C	5 ppm/ $^{\circ}$ C + 0.5 pA/ $^{\circ}$ C
	1 μ A	5 ppm/ $^{\circ}$ C + 3 pA/ $^{\circ}$ C	5 ppm/ $^{\circ}$ C + 1.5 pA/ $^{\circ}$ C
	10 μ A	2 ppm/ $^{\circ}$ C + 10 pA/ $^{\circ}$ C	5 ppm/ $^{\circ}$ C + 1 pA/ $^{\circ}$ C
	100 μ A	2 ppm/ $^{\circ}$ C + 200 pA/ $^{\circ}$ C	2 ppm/ $^{\circ}$ C + 1 pA/ $^{\circ}$ C
	1 mA	2 ppm/ $^{\circ}$ C + 500 pA/ $^{\circ}$ C	2 ppm/ $^{\circ}$ C + 20 pA/ $^{\circ}$ C
	10 mA	2 ppm/ $^{\circ}$ C + 10 nA/ $^{\circ}$ C	2 ppm/ $^{\circ}$ C + 5 nA/ $^{\circ}$ C
100 mA	2 ppm/ $^{\circ}$ C + 100 nA/ $^{\circ}$ C	5 ppm/ $^{\circ}$ C + 10 nA/ $^{\circ}$ C	

Impedance and bandwidth

	Range	Impedance		Bandwidth (typical)	
		Output (source)	Input (measure)	Source	Measure
Voltage	10 mV	0.6 Ω	>100 G Ω (typical, remote sense)	60 kHz	60 kHz
	100 mV				
	1 V				
	10 V				
Current	1 nA	>10 T Ω	100 k Ω	100 Hz	350 Hz
	10 nA	>1 T Ω	10 k Ω	500 Hz	1.1 kHz
	100 nA	>100 G Ω	1 k Ω	1 kHz	2 kHz
	1 μ A	>10 G Ω	100 Ω	4 kHz	10 kHz
	10 μ A	>1 G Ω	10 Ω	10 kHz	25 kHz
	100 μ A	>100 M Ω	1 Ω	50 kHz	65 kHz
	1 mA	>10 M Ω	100 m Ω	100 kHz	>100 kHz
	10 mA	>1 M Ω	20 m Ω	100 kHz	>100 kHz
100 mA	>100 k Ω	10 m Ω	100 kHz	>100 kHz	

VM-10 VOLTAGE MEASURE MODULE



This module provides voltage measurements with resolution from low nanovolts up to 10 V from DC to 100 kHz, including amplitude, phase, and harmonic detection capabilities. Proprietary seamless ranging technology allows continuous measurements when increasing or decreasing ranges. This patented capability significantly reduces or eliminates the typical range change-induced measurement offsets/discontinuities commonly seen in signal sweeping applications requiring numerous range changes. It's particularly useful when measuring I-V curves involving many data points and range changes and can reduce overall measurement time.

Voltage noise performance is on par with modern AC lock-in amplifier instruments but packaged in a compact, easy-to-use, remote-mountable module that can be located next to the sample or DUT to minimize cabling signal losses and noise pickup.

In addition, the module offers two configurable hardware low-pass and high-pass filters, which enable highly sensitive low-level measurements to be made in the presence of significant interfering signals. The inclusion of user-configurable hardware filters combined with the high-gain, low-noise front-end module amplifier design can eliminate the need for additional pre-amplifiers often required with traditional lock-in amplifiers. It also offers user-selectable single-ended or differential input connections providing additional options for minimizing noise and ground loop interference without the use of external converters or adapters.

Up to three simultaneously connected VM-10 modules can be used with each M81 instrument. Each module can be independently configured to perform DC, AC, or lock-in measurements.

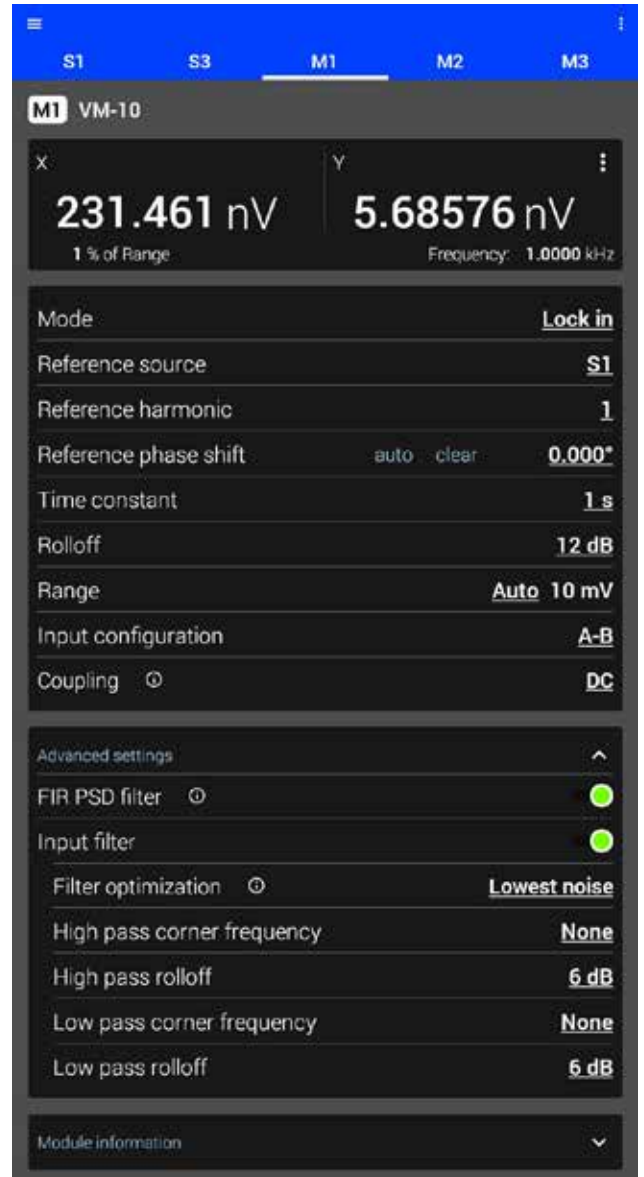

VM-10 specifications

Specifications are subject to change

Input configuration	Single-ended (A) or differential (A-B)
Input coupling	DC or AC (0.1 Hz)
Ranges	10 V, 1 V, 100 mV, 10 mV; seamless, automatic transitions
Best sensitivity	<1 nV ¹
Hardware filters	LP: 10 Hz, 30 Hz, 100 Hz, 300 Hz, 1 kHz, 3 kHz, 10 kHz; 20 dB or 40 dB/decade HP: 10 Hz, 30 Hz, 100 Hz, 300 Hz, 1 kHz, 3 kHz; 20 dB or 40 dB/decade Modes: High reserve, Low-noise
Typical input impedance	>1 TΩ, 120 pF (DC coupled)
Leakage current	<15 pA
CMRR	80 dB up to 1 kHz
Magnetic field exposure	Operational up to 8 mT DC
Size	142 mm W × 39 mm H × 89 mm D (5.6 in × 1.5 in × 3.5 in)

Bandwidth/accuracy

Range	Bandwidth (-3 dB, typical)	Single-ended operation			Differential operation		
		DC ² ±(%rdg + V)	Lock-in ^{2,3,4} ±%rdg + V	Temperature coefficient ^{2,3} ±(ppm rdg/°C + V/°C)	DC ² ±(%rdg + V)	Lock-in ^{2,3,4} ±%rdg + V	Temperature coefficient ^{2,3} ±(ppm rdg/°C + V/°C)
10 mV	75 kHz	0.1% + 20 μV	0.1% + 50 nV	120 ppm/°C + 20 μV/°C	0.025% + 150 μV	0.025% + 50 μV	6 ppm/°C + 1 μV/°C
100 mV	75 kHz	0.1% + 20 μV	0.1% + 500 nV		0.025% + 10 μV	0.025% + 5 μV	
1 V	>100 kHz	0.025% + 21 μV	0.025% + 5 μV	6 ppm/°C + 20 μV/°C	0.05% + 6 μV	0.05% + 500 nV	6 ppm/°C + 2 μV/°C
10 V	>100 kHz	0.025% + 600 μV	0.025% + 50 μV	6 ppm/°C + 24 μV/°C	0.05% + 6 μV	0.05% + 50 nV	6 ppm/°C + 6 μV/°C

Noise (typical)

Current noise at 1 kHz: 20 fA/√Hz

Voltage noise measured with filters off, inputs shorted

Range	Single-ended operation		Differential operation	
	Voltage noise at 1 kHz	Voltage noise at 0.1 Hz to 10 Hz	Voltage noise at 1 kHz	Voltage noise at 0.1 Hz to 10 Hz
10 mV	3.2 nV/√Hz	25 nV RMS; 125 nV p-p	4.1 nV/√Hz	30 nV RMS; 150 nV p-p
100 mV	3.8 nV/√Hz	50 nV RMS; 250 nV p-p	4.5 nV/√Hz	60 nV RMS; 300 nV p-p
1 V	50 nV/√Hz	400 nV RMS; 2 μV p-p	50 nV/√Hz	500 nV RMS; 2.5 μV p-p
10 V	170 nV/√Hz	4 μV RMS; 20 μV p-p	170 nV/√Hz	4 μV RMS; 20 μV p-p

¹ Lock-in measurement, 10 mV range, 10 s time constant, 24 dB rolloff, 95% confidence interval

² Total system accuracy, 95% confidence, 1 year and ±5 °C from Lake Shore calibration, 24 h and ±1 °C from self-calibration, filters off

³ DC to 1 kHz

⁴ Add 0.1% of reading when AC coupled

BCS-10 BALANCED CURRENT SOURCE MODULE



This module provides programmable currents from 1 pA to 100 mA with a ± 10 V maximum compliance output from DC to 100 kHz sinusoidal output. Derived from Lake Shore's industry-leading Model 372 AC resistance bridge, the BCS-10 employs a differential or balanced design that helps reduce or eliminate ground loops often encountered in cryostats and other research apparatus. It expands on Model 372 balanced source capability, adding variable frequency and amplitude programmability for enhanced flexibility while maintaining excellent noise performance.

The inclusion of a virtual center-point ground connection further enhances noise performance by allowing the user to determine optimal center-point tie points within given apparatus or equipment setups. The BCS-10 is designed to be paired with the VM-10 module, which provides both single-ended and differential (balanced) input connection and modes. The true differential (balanced) wiring configuration minimizes noise coupled from the environment, such as from power lines, lighting, motors, and other lab equipment.

A typical application of the balanced current source involves low-resistance measurements, where the resistance of the wires connecting the current source to a sensor may be significant. Any unbalance in lead wire resistance results in a common-mode voltage that complicates the measurement of the desired parameter, the voltage across the sensor. The external CMR feature is unique in that it allows the BCS-10 to force some remote node (such as a VM-10 input) to circuit common potential and thus mitigate the effect of unbalanced lead wire resistance.



BCS-10 specifications

Specifications are subject to change

Ranges	100 mA, 10 mA, 1 mA, 100 μ A, 10 μ A, 1 μ A, 100 nA, 10 nA; automatic selection
Compliance	20 V differential, 10 V single-ended (non-settable)
Maximum power	1 W, 4-quadrant operation
CMR modes	Off, internal, external
Coupling	DC or AC (1 Hz)
Guard drive	Enable or disable
Rise time	<25 μ s, 10% to 90%, zero to full scale, <1 Ω impedance load, 1 μ A and above ranges
Settle time	<60 μ s to 0.1% of final value, zero to full scale, <1 Ω impedance load, 1 μ A and above ranges
Load impedance	Stability maintained with reactive loads up to 50 μ F or 1 mH (with 100 Ω damping)
Magnetic field exposure	Operational up to 11 mT DC
Size	142 mm W \times 39 mm H \times 89 mm D (5.6 in \times 1.5 in \times 3.5 in)

Bandwidth/accuracy

Range	Bandwidth (typical)		DC ¹ \pm (% rdg + A)	Lock-in ^{1,2} \pm % rdg + A	Temperature coefficient ^{1,2} \pm (ppm rdg/ $^{\circ}$ C + A/ $^{\circ}$ C)	Settable resolution
	Maximum frequency	Full accuracy maximum frequency				
10 nA	100 Hz	30 Hz	0.5% + 30 pA	0.5% + 50 fA	5 ppm/ $^{\circ}$ C + 2 pA/ $^{\circ}$ C	100 fA
100 nA	1 kHz	100 Hz	0.5% + 60 pA	0.5% + 500 fA	5 ppm/ $^{\circ}$ C + 2 pA/ $^{\circ}$ C	1 pA
1 μ A	10 kHz	1 kHz	0.5% + 120 pA	0.5% + 5 pA	5 ppm/ $^{\circ}$ C + 2 pA/ $^{\circ}$ C	10 pA
10 μ A	100 kHz	1 kHz	0.03% + 1 nA	0.15% + 50 pA	2 ppm/ $^{\circ}$ C + 10 pA/ $^{\circ}$ C	100 pA
100 μ A	100 kHz	1 kHz	0.03% + 5 nA	0.15% + 500 pA	2 ppm/ $^{\circ}$ C + 200 pA/ $^{\circ}$ C	1 nA
1 mA	100 kHz	1 kHz	0.03% + 50 nA	0.15% + 5 nA	2 ppm/ $^{\circ}$ C + 500 pA/ $^{\circ}$ C	10 nA
10 mA	100 kHz	1 kHz	0.03% + 500 nA	0.15% + 50 nA	2 ppm/ $^{\circ}$ C + 10 nA/ $^{\circ}$ C	100 nA
100 mA	100 kHz	1 kHz	0.03% + 5 μ A	0.15% + 500 nA	2 ppm/ $^{\circ}$ C + 100 nA/ $^{\circ}$ C	1 μ A

Noise (typical)

Range	Noise density	Noise at 0.1 Hz to 10 Hz
10 nA	20 fA/ $\sqrt{\text{Hz}}$ at 10 Hz	150 fA RMS (750 fA p-p)
100 nA	50 fA/ $\sqrt{\text{Hz}}$ at 100 Hz	200 fA RMS (1 pA p-p)
1 μ A	150 fA/ $\sqrt{\text{Hz}}$ at 1 kHz	600 fA RMS (3 pA p-p)
10 μ A	450 fA/ $\sqrt{\text{Hz}}$ at 1 kHz	1.5 pA RMS (7.5 pA p-p)
100 μ A	2.5 pA/ $\sqrt{\text{Hz}}$ at 1 kHz	50 pA RMS (250 pA p-p)
1 mA	20 pA/ $\sqrt{\text{Hz}}$ at 1 kHz	400 pA RMS (2 nA p-p)
10 mA	200 pA/ $\sqrt{\text{Hz}}$ at 1 kHz	2 nA RMS (10 nA p-p)
100 mA	1.2 nA/ $\sqrt{\text{Hz}}$ at 1 kHz	10 nA RMS (50 nA p-p)

DC output impedance

Range	Magnitude output impedance
10 nA	>100 G Ω
100 nA	>100 G Ω
1 μ A	>10 G Ω
10 μ A	>1 G Ω
100 μ A	>100 M Ω
1 mA	>10 M Ω
10 mA	>1 M Ω
100 mA	>100 k Ω

¹ Total system, 1 year and ± 5 $^{\circ}$ C from Lake Shore calibration, 24 h and ± 1 $^{\circ}$ C from self-calibration, 95% confidence

² DC to full accuracy frequency

CM-10 CURRENT MEASURE MODULE



This module provides current measurements with near-zero input offset voltage from fA levels up to 100 mA from DC to 100 kHz, including amplitude, phase, and harmonic detection capabilities. The module also has configurable hardware and software filtering.

Current noise performance is on par with modern TIA and DC picoammeters, and the module also includes a programmable ± 10 V voltage bias offset feature for materials or devices that require biased current measurements or operation, such as a photodiode.

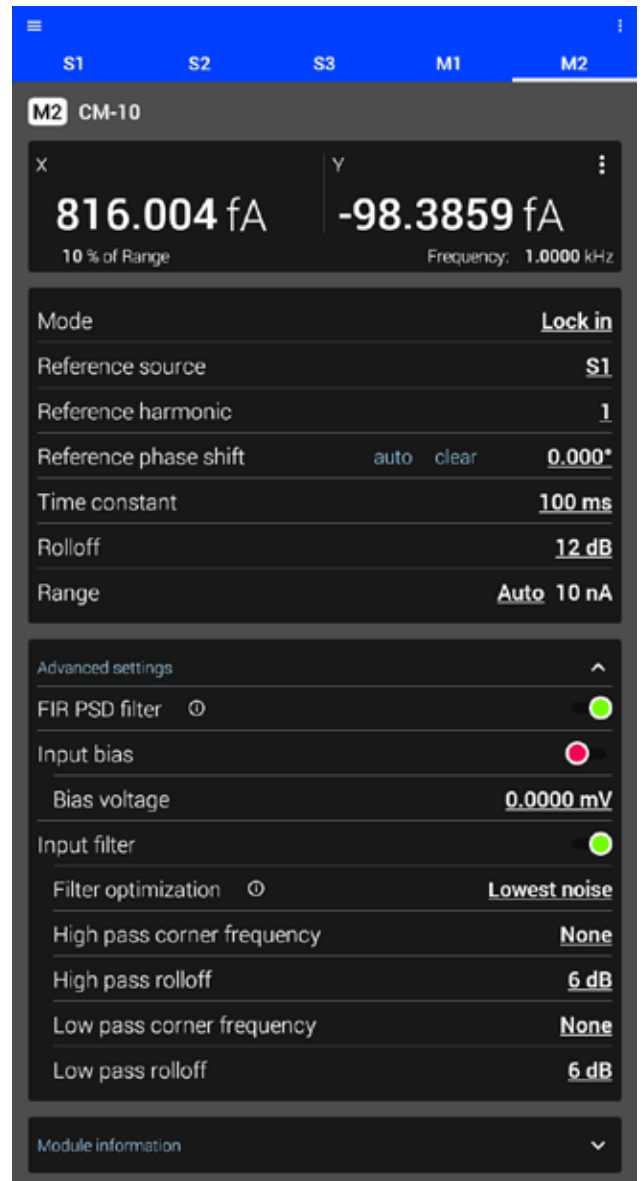

CM-10 specifications

Specifications are subject to change

Ranges	100 mA, 10 mA, 1 mA, 100 μ A, 10 μ A, 1 μ A, 100 nA, 10 nA, 1 nA; automatic transitions
Input offset voltage²	<150 μ V
Settable bias voltage	\pm 10 V
Bias voltage settable resolution	320 μ V
Best sensitivity	<10 fA ¹
Hardware filters	LP: 10 Hz, 30 Hz, 100 Hz, 300 Hz, 1 kHz, 3 kHz, 10 kHz; 20 dB or 40 dB/decade HP: 10 Hz, 30 Hz, 100 Hz, 300 Hz, 1 kHz, 3 kHz; 20 dB or 40 dB/decade Modes: High reserve, Low-noise
Magnetic field exposure	Operational up to 3 mT DC
Max input capacitance to ground	100 nF
Size	142 mm W \times 39 mm H \times 89 mm D (5.6 in \times 1.5 in \times 3.5 in)

Bandwidth/accuracy

Range	Bandwidth (-3 dB, typical)	Full accuracy	DC ² \pm (% rdg + A)	Lock-in ^{2,3} \pm % rdg + A	Temperature coefficient ^{2,3} \pm (% rdg/ $^{\circ}$ C + A/ $^{\circ}$ C)
1 nA	80 Hz	10 Hz	0.1% + 5 pA	0.5% + 5 fA	50 ppm/ $^{\circ}$ C + 0.5 pA/ $^{\circ}$ C
10 nA	80 Hz	10 Hz	0.1% + 5 pA	0.5% + 50 fA	50 ppm/ $^{\circ}$ C + 0.5 pA/ $^{\circ}$ C
100 nA	450 Hz	20 Hz	0.05% + 10 pA	0.1% + 500 fA	5 ppm/ $^{\circ}$ C + 0.5 pA/ $^{\circ}$ C
1 μ A	2.2 kHz	100 Hz	0.05% + 500 pA	0.1% + 5 pA	5 ppm/ $^{\circ}$ C + 0.5 pA/ $^{\circ}$ C
10 μ A	8 kHz	500 Hz	0.05% + 500 pA	0.05% + 50 pA	5 ppm/ $^{\circ}$ C + 5 pA/ $^{\circ}$ C
100 μ A	40 kHz	1 kHz	0.05% + 1 nA	0.05% + 500 pA	2 ppm/ $^{\circ}$ C + 50 pA/ $^{\circ}$ C
1 mA	>100 kHz	1 kHz	0.05% + 10 nA	0.05% + 5 nA	2 ppm/ $^{\circ}$ C + 500 pA/ $^{\circ}$ C
10 mA	>100 kHz	1 kHz	0.05% + 100 nA	0.05% + 50 nA	2 ppm/ $^{\circ}$ C + 5 nA/ $^{\circ}$ C
100 mA	>100 kHz	1 kHz	0.05% + 1 μ A	0.05% + 500 nA	5 ppm/ $^{\circ}$ C + 50 nA/ $^{\circ}$ C

Noise (typical)

Range	Noise density ⁴	Noise at 0.1 Hz to 10 Hz ⁴
1 nA	4.3 fA/ \sqrt Hz at 77 Hz	16 fA RMS (80 fA p-p)
10 nA	4.3 fA/ \sqrt Hz at 77 Hz	16 fA RMS (80 fA p-p)
100 nA	13 fA/ \sqrt Hz at 100 Hz	60 fA RMS (300 fA p-p)
1 μ A	70 fA/ \sqrt Hz at 1 kHz	400 fA RMS (2 pA p-p)
10 μ A	500 fA/ \sqrt Hz at 1 kHz	4 pA RMS (20 pA p-p)
100 μ A	3.5 pA/ \sqrt Hz at 1 kHz	30 pA RMS (150 nA p-p)
1 mA	30 pA/ \sqrt Hz at 1 kHz	350 pA RMS (1.75 nA p-p)
10 mA	250 pA/ \sqrt Hz at 1 kHz	4 nA RMS (20 nA p-p)
100 mA	2.6 nA/ \sqrt Hz at 1 kHz	35 nA RMS (175 nA p-p)

DC input impedance

Range	DC input impedance
1 nA	5 k Ω
10 nA	500 Ω
100 nA	50 Ω
1 μ A	50 Ω
10 μ A	5 Ω
100 μ A	1 Ω
1 mA	200 m Ω
10 mA	200 m Ω
100 mA	200 m Ω

¹ 1 nA range, 10 s, 95% confidence interval

² Total system accuracy, 1 year and \pm 5 $^{\circ}$ C from Lake Shore calibration; 24 h, \pm 1 $^{\circ}$ C from self-calibration, 95% confidence, filters off

³ DC to full accuracy frequency

⁴ In Low noise mode; High reserve mode will have the noise of the next higher current range

VS-10 VOLTAGE SOURCE MODULE



This module provides programmable voltages from ± 1 nV to ± 10 V with a maximum of 100 mA compliance from DC to 100 kHz sinusoidal output. The VS-10 is useful for gate biasing, voltage sweep I-V curve profiling, and applications that require highly stable voltages in combination with current, resistance/conductance, and other material or electronic device measurements.

Patented circuitry enables separate ranges and amplitude settings for DC and AC signal components. This technology benefits device measurements that require both DC voltage bias and small signal AC characterization stimulus. This is because a single VS-10 module operates equivalent to two separate single-function DC and AC voltage sources. It allows for simultaneous DC biasing and sweeping as well as combined AC signals to be superimposed for sample and device stimulus and selective measurement by corresponding and synchronized VM-10 modules. This hybrid DC+AC signal capability can reduce or eliminate the need and complexity for dedicated DC and AC sources while providing enhanced characterization capabilities and richer measurement data and sample insights.

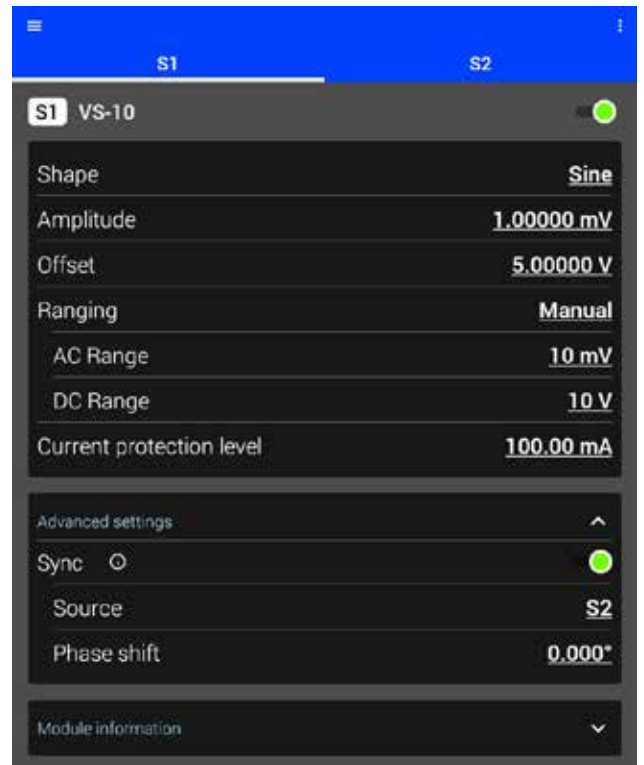

VS-10 specifications

Specifications are subject to change

Ranges	V: 10 V, 1 V, 100 mV, 10 mV; AC and DC ranges can be independently set; automatic selection
Current limit	Settable up to 100 mA (DC only)
Maximum power	1 W, 4-quadrant operation
Output impedance	<150 mΩ
Rise time	<5 μs, 10% to 90%, negative to positive full scale, >10 MΩ impedance load, all ranges
Settle time	<10 μs to 0.1% of final value, negative to positive full scale, >10 MΩ impedance load, all ranges
Load impedance	Stability maintained with reactive loads up to 50 μF or 1 mH (with 100 Ω damping)
Magnetic field exposure	Operational up to 50 mT DC
Size	142 mm W × 39 mm H × 89 mm D (5.6 in × 1.5 in × 3.5 in)

Bandwidth/accuracy

Range ¹	Bandwidth (-3 dB, typical)	DC ² ±(% rdg + V)	Lock-in ^{2,3} ±% rdg + V	Temperature coefficient ^{2,3} ±(ppm rdg/°C + V/°C)	DC settable resolution ⁴	AC settable resolution
10 mV	95 kHz	0.15% + 450 μV	0.15% + 50 nV	5 ppm/°C + 5 μV/°C	1 μV	100 nV
100 mV	95 kHz	0.1% + 450 μV	0.1% + 500 nV	5 ppm/°C + 5 μV/°C	1 μV	1 μV
1 V	95 kHz	0.05% + 450 μV	0.05% + 5 μV	5 ppm/°C + 5 μV/°C	1 μV	10 μV
10 V	95 kHz	0.025% + 450 μV	0.025% + 50 μV	5 ppm/°C + 5 μV/°C	3 μV	100 μV

Noise (typical)

Range	Voltage noise at 1 kHz	Voltage noise at 0.1 Hz to 10 Hz
10 mV	40 nV/√Hz	350 nV RMS (1.75 μV p-p)
100 mV	40 nV/√Hz	350 nV RMS (1.75 μV p-p)
1 V	40 nV/√Hz	500 nV RMS (2.5 μV p-p)
10 V	100 nV/√Hz	1 μV RMS (5 μV p-p)

Output impedance

Range	Absolute resistance
10 mV	<0.1 Ω
100 mV	<0.1 Ω
1 V	<0.1 Ω
10 V	<0.1 Ω

Wideband noise (DC to 100 MHz): 2 mV RMS

¹ Both DC and AC range less than or equal to the range

² Total system accuracy, 1 year and ±5 °C from Lake Shore calibration, 24 h and ±1 °C from self-calibration, 95% confidence

³ DC to 1 kHz

⁴ Averaging over 60 NPLCs

M81-SSM AND LAKE SHORE MEASURELINK™ SOFTWARE

Lake Shore MeasureLINK™ optional PC software is an easy, non-programming way to coordinate sophisticated electrical measurements as source or environment parameters change over time.



- Install application packs
 - They provide access to temperature, field, and electrical instrumentation drivers
- Build a system configuration that includes all of the instruments in the experiment
 - Monitor and control the instruments from the Monitor pane
- Build a sequence using drag-and-drop components to control temperature, field, and electrical parameter sweeps
- Collect data from the experiment and export it to your favorite analysis tool
- Need to build an experiment that isn't fully supported? No problem, simply make a similar drag-and-drop sequence and export it to a custom programming environment for final customizations. No problem is too complex to handle.

The MeasureLINK interface

The screenshot displays the MeasureLINK software interface with several key components labeled:

- Ribbon:** Located at the top, it contains various toolbars for file operations, measurement setup, and data handling.
- Navigation pane:** Located on the left, it shows a sequence of steps for the experiment, such as "Step 1.1.1 Discrete Electrical Source Loop".
- Workspace:** The central area where instrument configurations and loop parameters are defined. It includes sections for "Instrument Configuration" (e.g., Instrument: Ls155, Source mode: Voltage) and "Loop Configuration" (e.g., Loop spacing: Linear, Number of points: 11).
- Monitor pane:** Located on the right, it provides real-time data and control for the instruments. It shows "System Status" (Idle), "336 Temperature Controller" (12.000 K), "Lake Shore 155 Source" (10.00 mV), and "M81 VM Voltage Measure" (3.3784 μV, 21.12 °).



MEASURELINK™ MEASUREMENT SEQUENCE EXAMPLE

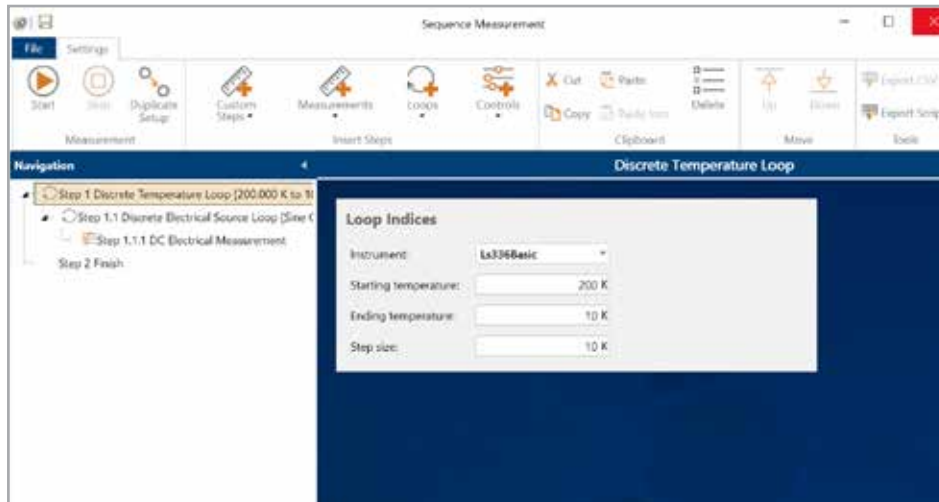

In a temperature-dependent electrical measurement, Step 1 would be to set up a discrete temperature loop with start, end, and step temperature values.

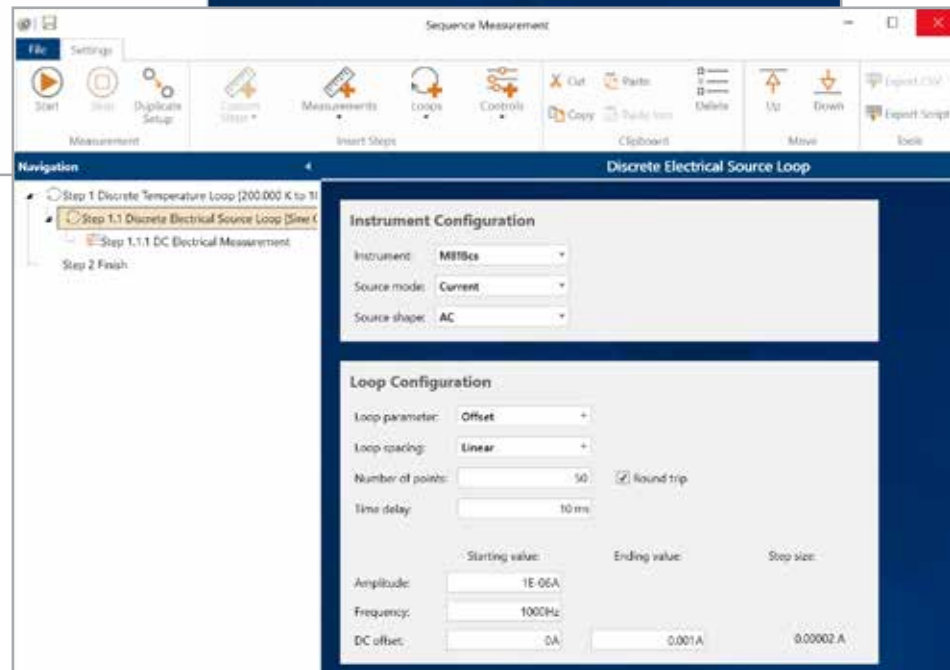

Step 2: Configure the electrical source sweep, which includes specifying the instrument, source mode (voltage or current, source shape [DC or AC]), followed by the loop configuration parameters, such as sweep variable (amplitude, frequency, or offset) and related start, end, and step parameters.

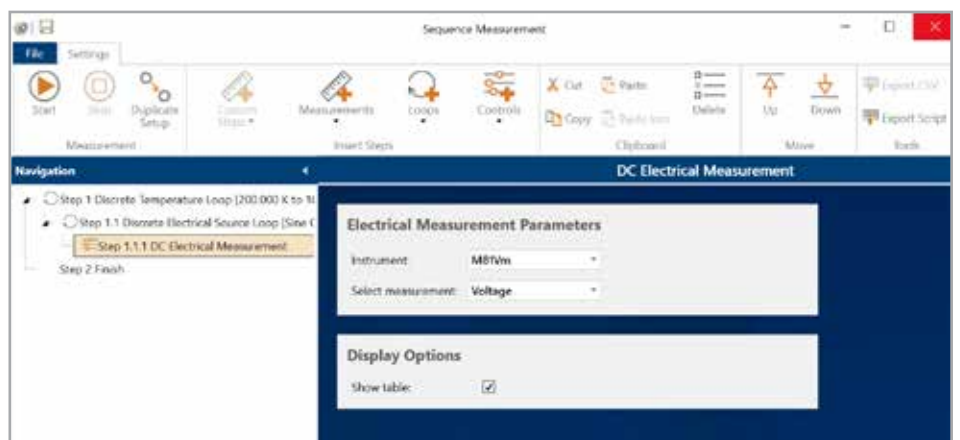

Step 3: Add an electrical measurement step. Start execution and then collect the data in a table for easy export to your favorite analysis program.

TOP MATERIAL RESEARCH APPLICATIONS AND THE M81 MODULES USED

DC transport

I-V curves, 4-wire

(VS module + CM module, primarily)

Ideal for: 2D materials, nanowires, organic semiconductors

M81-SSM advantages: Low-voltage source noise, low-current measure noise

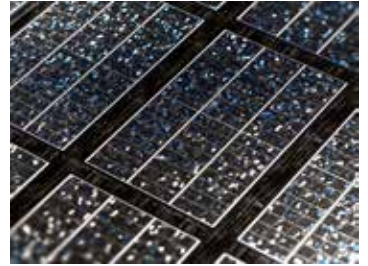

AC transport

AC resistance, sheet resistance, and AC current Hall

(BCS module + VM module)

Ideal for: Metal-insulator transitions, 2D materials, superconducting materials

M81-SSM advantages: AC current Hall: synchronous measurement of resistance and Hall voltages; and simultaneous measurement of up to three devices in a cryostat at different frequencies

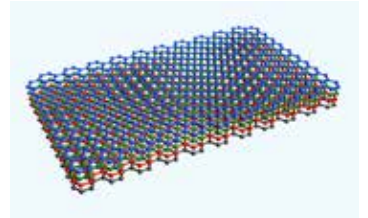

Photodiodes and phototransistors

(CM module + occasionally VS module)

Ideal for: IR sensitive materials, solar-blind materials, 2D materials

M81-SSM advantages: Programmable offset voltage source

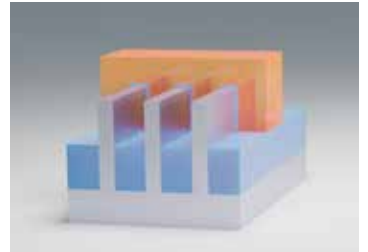

Spin transport

(DC/AC: BCS module + VM module)

Ideal for: Spin orbit torque (SOT), non-local resistance, spin valves

M81-SSM advantages: SOT: synchronous measurement of resistance, Hall voltages, and harmonic Hall voltages



Differential conductance

(VS module + CM module)

Ideal for: MIS junctions, Josephson junctions, defect characterization in transistors

M81-SSM advantages: Junctions: dual DAC AC and DC sourcing (source at appropriate range)



Thermal transport

(AC, BCS module + VM module)

Ideal for: Thermoelectric materials, 1D materials

M81-SSM advantages: Phase-correlated current sources, synchronous harmonic detection

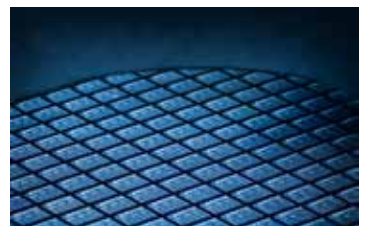

APPLICATION FOCUS – M81 AND HALL BAR MEASUREMENTS

Magnetotransport and harmonic Hall effect measurements are primary characterization methodologies for a wide variety of materials — high mobility 2DEGs, graphene, magnetic semiconductors, and spin-orbit torque heterostructures. For low resistance materials in particular, samples are often etched or milled into a Hall bar geometry and a current source drives a uniform current through the long axis of the bar. The voltage drop along the current channel, V_R , is measured using narrow legs or taps along the current direction. Deflection of the current due to applied and internal magnetic fields manifests as a Hall voltage, V_H , detected in the legs perpendicular to the current flow. In certain applications, the measured voltages are exceedingly small and need to be extracted using lock-in techniques. The M81-SSM offers key advantages in these scenarios for both sourcing and detection.

AC current source

Conventionally, single-ended current sources are employed in Hall bar measurements. These single-ended sources drive current into the positive terminal of the Hall bar, which is returned to ground. In the single-ended configuration, there is a different impedance on each end of the Hall bar load and common mode voltage fluctuations, such as line pickup, are more easily coupled into the measurement circuit. With these common mode fluctuations, longer lock-in averaging times may be necessary in order to achieve an acceptable signal to noise ratio. Minimizing common mode fluctuations in Hall bar applications, the M81-SSM is configured with a balanced current source (BCS) for AC current excitation of the device. Configured as a differential source, the BCS module sources and sinks the prescribed current with two coordinated voltage-controlled source circuits. A common mode rejection connection on the source module is attached to a Hall bar's shared leg and provides active feedback to reduce common mode voltage on the load.

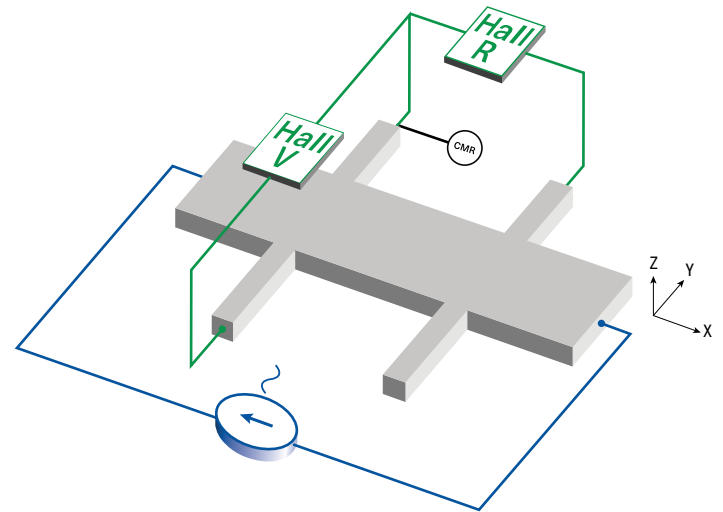

Voltage detection

In AC current Hall bar measurements, two lock-in amplifiers are typically used in order to simultaneously measure V_R and V_H as a function of magnetic field or temperature. Due to cost considerations, a single lock-in could be switched between the two voltage measurement configurations; however, waiting for the lock-in to resettle after a configuration change is time-consuming. As the two measurements are acquired at different times, system drift can skew measurement results. For typical Hall bar measurements, the M81-SSM can be configured with two voltage measure (VM) modules — one for V_H and one for V_R . For harmonic Hall measurements, the second harmonic of the oscillating Hall voltage characterizes the strength and nature of the spin-orbit interaction. In this case, a third VM module, configured to measure the second harmonic, is added in parallel to the V_H legs. Whether configured with two or three VM modules, the M81-SSM platform can be queried to return synchronous lock-in results from all connected measurement modules.

POSITIONING AND MOUNTING ACCESSORIES

Included mounting plates



Included with each module: a top clip for module-to-module stacking and a bottom clip for surface mounting (shown attached underneath).

Optional module rack mount kit (M81-RMP-3)



Optional module rack mount panel (M81-RMK-2)

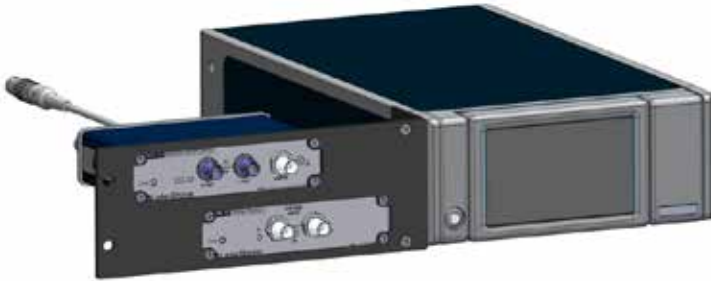

Two optional module rack mount kits (M81-RMP-3) paired with an optional rack mount kit for two MeasureReady instruments (RM-2)



Optional probe station mounting kit (M81-PMK-1)

Includes shelf for mounting M81-SSM modules on Lake Shore probe stations adjacent to a DUT.

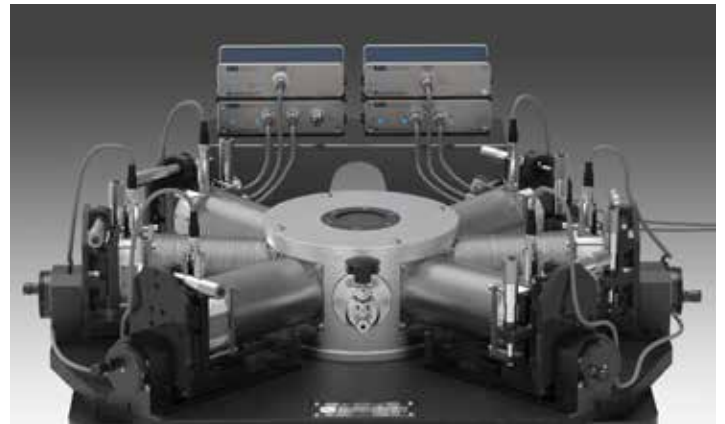

ORDERING INFORMATION

M81 instruments

M81-SSM-2	M81 synchronous source measure system instrument with 1 source and 1 measure channel
M81-SSM-4	M81 synchronous source measure system instrument with 2 source and 2 measure channels
M81-SSM-6	M81 synchronous source measure system instrument with 3 source and 3 measure channels

M81-SSM source and measure modules

M81-SMU-10	10 V/100 mA source measure module
M81-BCS-10	100 mA/10 V balanced current source module
M81-VS-10	10 V/100 mA voltage source module
M81-VM-10	10 V voltage measure module
M81-CM-10	100 mA/10 V current measure module

MeasureLINK

ML-MCS	MeasureLINK-MCS software with scripting development license
ML-AP-MULTIVU	MeasureLINK-MCS application pack; Quantum Design MultiVu software access

Accessories

112-812	Instrument LEMO to BNC adapter cable, 2 m (6.6 ft)
112-815	Instrument LEMO to module extension cable, 4 m (13 ft)
112-819	PPMS to Lake Shore M81-BNC-DB25 cable, 2 m (6 ft)
601-804	0.91 m (36 in) BNC cable
601-804B	0.46 m (18 in) BNC cable
654-275	Triaxial to BNC adapter (2 included with each M81-BCS-10)
843-076	Low noise triaxial cable, 3-slot, 1 m (3 ft)
P12379	BNC female to triaxial adapter, TRB male, isolated, 50 Ω , 3-lug
117-017	1 m (3.3 ft) long IEEE-488 (GPIB) computer interface cable assembly
RM-2	Rack mount kit—two adjacent half-rack instruments
RM-1/2	Rack mount kit—single half-rack instrument
M81-RMK-2	Rack mount kit for M81 instrument and 2 modules (2U)
M81-RMP-3	Rack mount kit for 3 M81-SSM modules (1U)
M81-PMK-1	Mounting kit for mounting M81-SSM modules on a Lake Shore probe station
M81-MODULE-CLIPS	Mating pair of 2 stacking/mounting clips for M81-SSM modules including rubber feet and mounting screws
M81-TEST-KIT	Demo test box kit with 5 plug-in sample cards, cables
M81-BNC-DB25	Breakout box adapter for QD DynaCool/OptiCool systems with M81-SSM

 Measure Ready

M81
SSM

Questions? Answers?

Visit <http://forums.lakeshore.com/>
and become part of the conversation!



The screenshot shows the Lake Shore Cryotronics User Group Forum interface. At the top is the Lake Shore Cryotronics logo. Below it is the title "User Group Forum". A navigation bar includes "Home" and a search box with a "Search" button. A breadcrumb trail reads "Lake Shore > Material Characterization Products > Meas". A message says "Talk to fellow users and Lake Shore experts". A "Sub-Boards" section contains a table with one entry: a folder icon, the board name "I/V source discussion", and a description "Discuss Lake Shore I/V source applications, revie".

	Board
	I/V source discussion Discuss Lake Shore I/V source applications, revie

© 2026 Lake Shore Cryotronics, Inc. All rights reserved. Specifications are subject to change.

Lake Shore Cryotronics, the Lake Shore logo, the square graph logomark, and Cemox are registered trademarks of Lake Shore Cryotronics, Inc.

All other trade names referenced are the service marks, trademarks, or registered trademarks of their respective companies.

050126

