

Measure Ready

# M81 SSM

A unique instrument architecture optimized to provide **synchronous** DC, AC, and mixed DC+AC source and measure to 100 kHz for low-level measurements

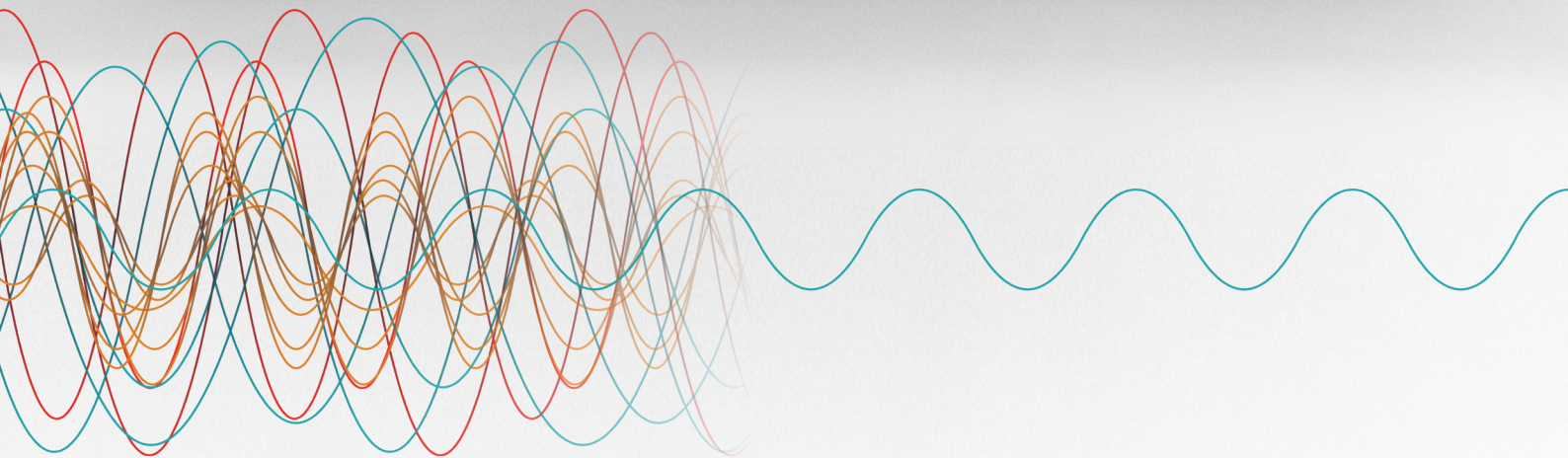
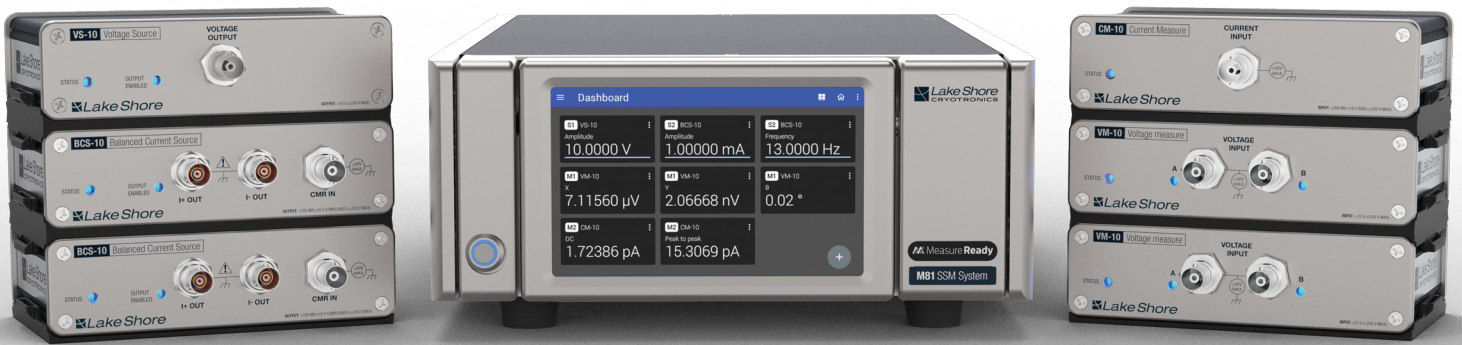

# An innovative architecture for coordinating low-level measurements from DC to 100 kHz

The MeasureReady™ M81-SSM (Synchronous Source and Measure) system provides a confident and straightforward approach for advanced measurement applications. The M81 is designed to eliminate the complexity of multiple function-specific instrumentation setups, combining the convenience of DC and AC sourcing with DC and AC measurement, including a lock-in's sensitivity and measurement performance.

Highly adaptable for a range of material and device research applications, the extremely low-noise system ensures synchronized measurements from 1 to 3 source channels and from 1 to 3 measure channels per half-rack instrument. Also, when its BCS-10 and VM-10 modules are combined, the system offers differential wiring to the sample—a proven method of minimizing environmental noise pickup that can interfere with low-level measurements.

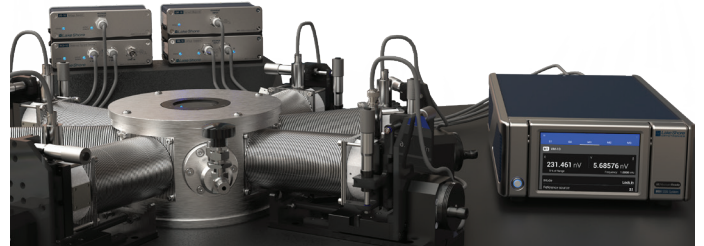

## Patented real-time sampling architecture for synchronous sourcing and measuring

- MeasureSync™ technology for simultaneous source module update and measure module sampling timing across all channels
- DC/AC amplitude and phase detection is user-selectable on all measure channels
- Common DAC/ADC sampling clock ensures highly precise and consistent source/measure timing coordination between 3 sources and 3 measures



## The absolute precision of DC plus the detection sensitivity performance of AC instrumentation

- All source and measure channels are capable of combined DC and AC to 100 kHz signals
- Optimized for fundamental, harmonic, and phase AC plus DC biased measurements
- Modularity allows for flexible, user-configured modules to suit a specific application



## Designed for scientific-grade low-level measurement applications

- Linear module power supply architecture for lowest possible source/measure noise
- Fully analog signal paths between data converters, modules, and the device under test (DUT)
- Remote modules for the shortest possible signal path to the DUT, which separates sensitive analog circuits from digital circuits and unwanted sources of interference typical of traditional single-enclosure instrument designs



## Unique, flexible instrument/ distributed module architecture

- Remote-mountable amplifier modules are interchangeable between instruments
- Modules are dynamically recognized when the system is reconfigured
- Uses a clean, simple UI and a common programming API for fast setup and a shorter learning curve

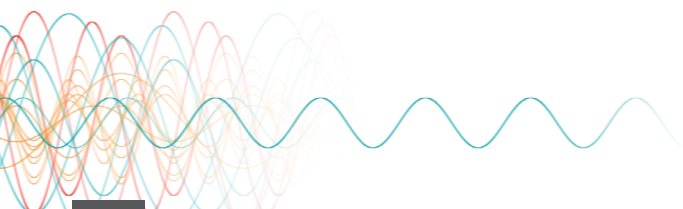

# Components of the M81-SSM system

- Connect up to three source modules and up to three measure modules
- Exchange modules and adapt the configuration for each measurement
- All modules are capable of measuring with DC and AC to 100 kHz
- All modules are optimized for highest precision with common amplitude and frequency references

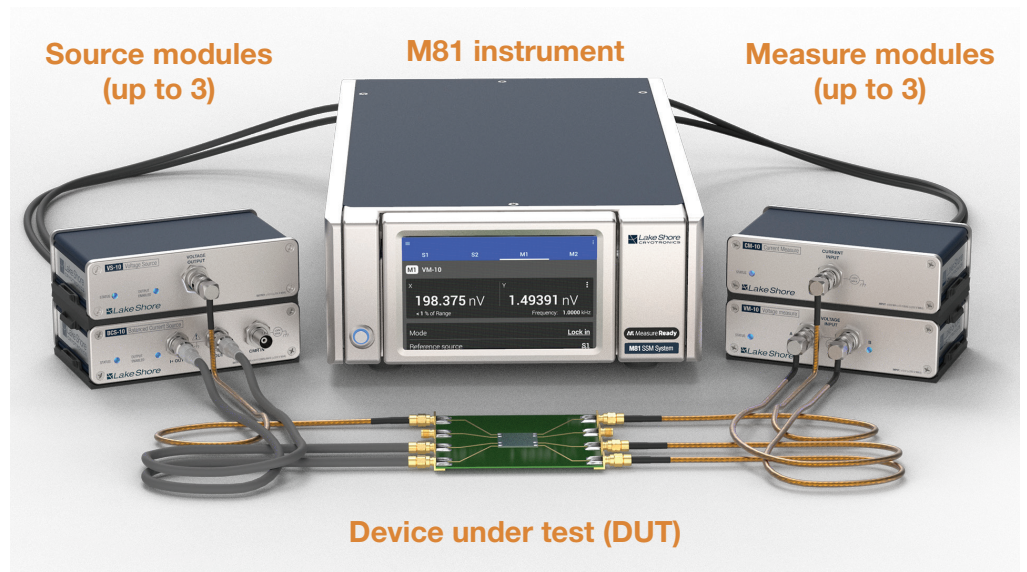

## Flexible measurement capabilities

The M81-SSM provides DC and AC stimulus and measurement capabilities for characterizing materials and devices in cryogenic, room temperature, and high-temperature environments.

Choose a combination of differential current source and voltage measurement modules for low-resistance applications requiring a precise stimulus current and the noise-cancellation benefits of balanced (floating) sample connections. Or mix and match with additional voltage source and current measurement modules for complex higher-impedance or gate-biasing applications where precise voltage control and sweeping test regimes are required.

Unlike a narrow-bandwidth DC system, these modules operate from very low frequencies to 100 kHz. You can select a measurement bandwidth to avoid 1/f noise and other bands where test environment noise is highest.

The system's MeasureSync™ technology samples all sourcing and measurement channels at precisely the same time, enabling multiple DUTs to be tested under identical conditions so you can obtain consistent data.

Add in Lake Shore MeasureLINK™ software to provide configurable measurement scripts and loops supporting a variety of applications. It facilitates easy integration with Lake Shore and third-party systems.

These combined capabilities make the M81-SSM a superior solution for characterizing several test structures, including nanostructures, single- and multilayer atomic structures, MEMs, quantum structures, organic semiconductors, and superconducting materials.

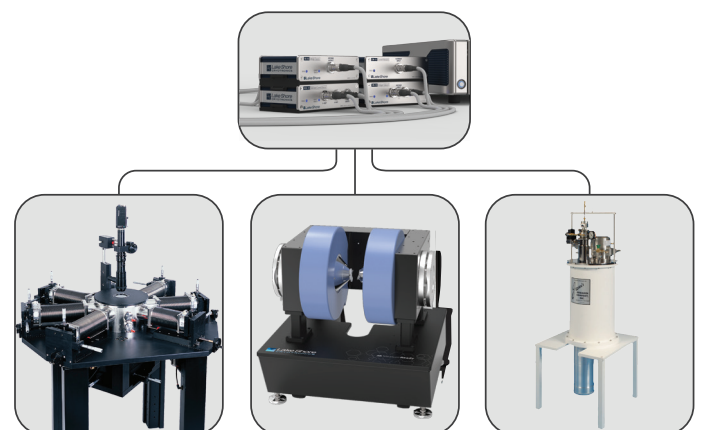

# MeasureSync™ architecture explained

The MeasureReady M81-SSM uses patented\* MeasureSync™ signal synchronization, enabling continuous data sampling on every channel (see full explanation on page 5). Noise and sensitivity are on par with the best scientific-grade source and measure instruments.

The M81-SSM simplifies the setup and operation of complex material characterization operations by reducing the number and types of instruments and software required. It unifies all configuration and experiment functions through a single interface. Measurements can be conducted using powerful MeasureLINK™ software.

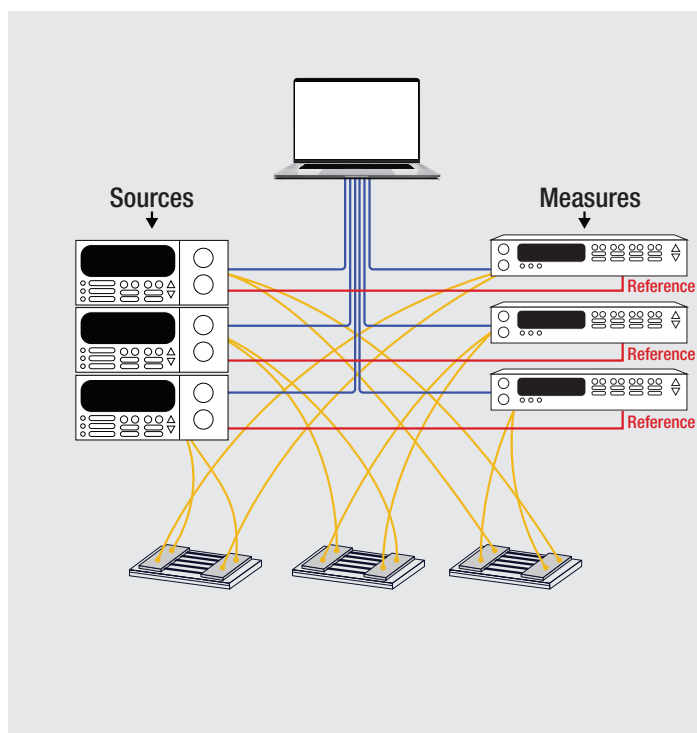

## Traditional equipment setup for multiple devices

- Typical material and device characterization applications require a combination of both DC and AC instruments
- These experimental setups often involve physically large sample apparatus machinery, requiring long signal cables between the sample and instruments
- Many applications require multiple channels of source and measure capabilities, creating synchronization challenges
- 'Rack and stack' approaches to modularity have required high levels of operator skill for reliable results
- As source and measure channel counts increase, so does the need for redundant, separate instruments – which can add to the overall cost of implementation

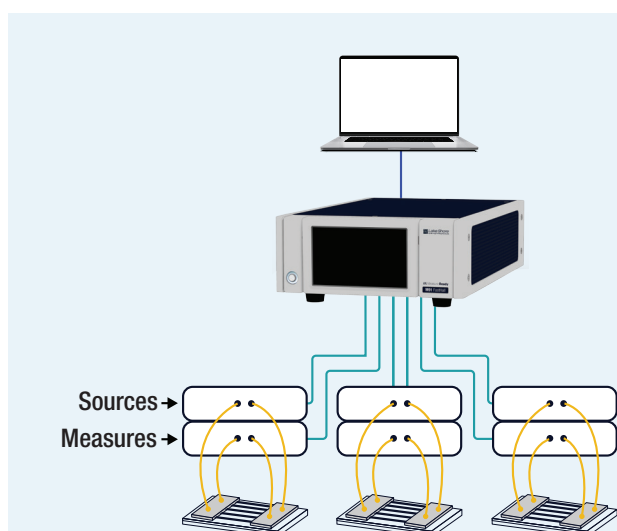

## The M81 simplifies these measurements by:

- Reducing the number of separate instruments for easier setup and operation and combining the capabilities of DC picoammeters, voltmeters, and AC lock-in amplifiers
- Reducing the number of and lengths of signal cables between source, measure, and sample, minimizing parasitics (leakage, noise, resistance, and reactance)
- Increasing the number of channels and thus enabling synchronized or parallel sample/device testing
- Allowing for easy reconfiguration by simply swapping module configurations for various applications
- Being typically much less expensive than multiple-instrument configurations

\*Protected by US patent number 20240019517-A1. Other patents pending.

# Timing is everything.

## Now it's automatic.

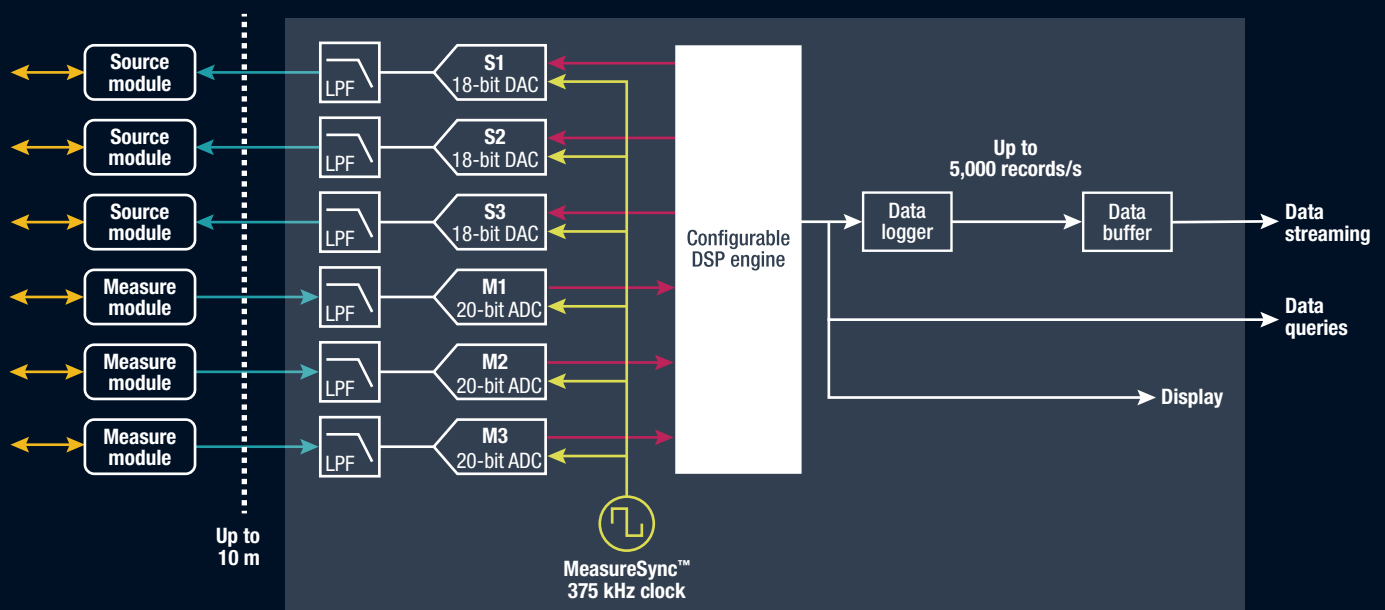

MeasureSync architecture allows for tightly synchronized data collection from the remotely located modules. Amplitude and frequency signals are transmitted to/from the remote amplifier modules using a proprietary, real-time analog voltage method that minimizes noise and ground errors while ensuring tight synchronization of all modules. This analog interface keeps noisy digital circuitry away from the modules' sensitive analog circuits. The signals are digitized by a dedicated converter for each channel, which are synchronized by the shared MeasureSync clock. Each rising edge of the clock triggers every ADC to take a reading and triggers each DAC to update its output. In between clock edges, all of the data is transferred from ADCs to the controller and each DAC is preloaded with a value that is applied on the next edge. Unlike multiplexed systems, this maintains total synchronization and continuous sampling of each channel. Digital signals are generated or processed by a configurable DSP core.

Each measure channel can be configured to perform DC, AC, or lock-in measurements. The core processes the individual readings collected at 375 kSa/s and produces fully processed and calibrated readings at up to 5 kSa/s. These readings can be observed on the front panel and collected via the remote interface.

The multiple parameter query structure allows a single data query to return multiple readings in one query, which maintains synchronization. Additionally, the configurable data streaming interface can be used to provide a continuous stream of synchronized data at a fixed, regular time interval, or a burst of high-speed collection. This combination of an analog interface to the distributed modules, a centralized simultaneous acquisition clock, and a unified remote interface provides end-to-end signal synchronization that cannot be easily achieved with separate instrumentation.

# Modules using patented signal technology

The M81-SSM system provides DC to 100 kHz precision electrical source and measure capabilities with 375 kHz (2.67  $\mu$ s) source/measure digitization rates across up to 3 source and 3 measurement front-end modules.

All modules are designed with linear circuitry powered by highly isolated linear power supply designs for the lowest possible voltage/current noise performance – rivaling modern lock-in amplifiers and research lab-grade source and measure instruments.

These quick-swappable modules with embedded calibration data enable quick measurement reconfiguration during and between experimental setups. Compact and well shielded, the modules can be remote, rack, or benchtop mounted depending on application requirements and user preference. For interconnection to the main instrument, the modules come standard with 2 m cables, but you can also order optional 8 m extender cables for making connections up to 10 m in length.

## Built-in patented capabilities include:

- Patented† dual AC and DC range sourcing – allowing for precise, full control of DC and AC amplitude signals with a single module and sample/device connection (VS-10 module)
- Patented†† seamless range change measuring – for significantly reducing or eliminating the typical range change-induced measurement discontinuities in signal sweeping applications that require numerous range changes (VM-10 module)

## The integration of both AC and DC into single source and measurement modules:

- Simplifies connections to the device under test
- Simplifies ground return connection schemes
- Simplifies test programming by allowing DC and AC signals to be sourced and measured under program control and without changing hardware or connections
- Enables AC modulation with a DC bias and allows a high degree of signal flexibility and measurement resolution options

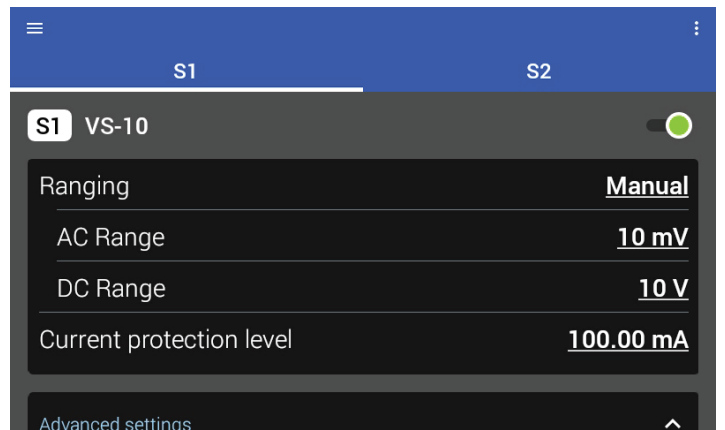

Dual AC and DC range source settings on the VS-10 module enable better control of DC and AC amplitude signals.

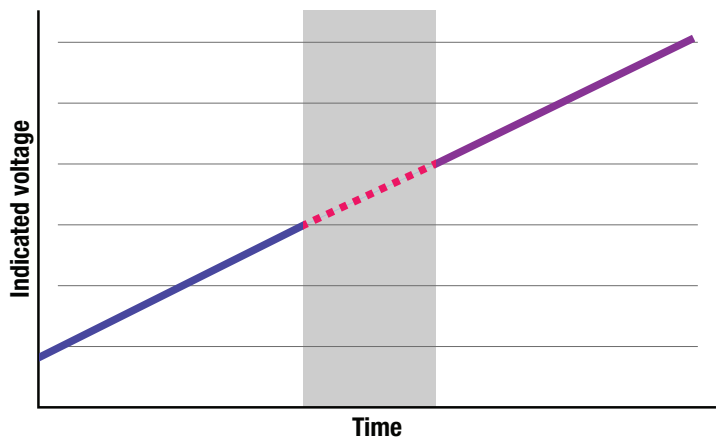

- Signal on range 1
- Signal on range 2
- M81 provides continuously observed signal
- Measurements lost during typical instrument range change

Seamless range change measuring is provided with the VM-10 module, as demonstrated by this voltage vs. time sweep.

† Protected by US patent number 11959991-B2. Other patents pending.

†† Protected by US patent number 11982730-B2. Other patents pending.

# As easy to use as your smartphone

The M81 instrument front display has an easy independent setup of each module's output or input parameters, including range, amplitudes, frequencies, and filters. Each module has a full screen of controls on the M81, similar to the VM-10 screen shown here. The output settings or measure input data of each module are easy to manipulate (S1, S2, S3, M1, M2, or M3). The result is an easy setup to make and see measurement results. To collect several measurements over time as a source is ramped or an environment parameter is changed like temperature or field, Lake Shore created MeasureLINK software to control environmental or source parameters over time and capture the measurement data.

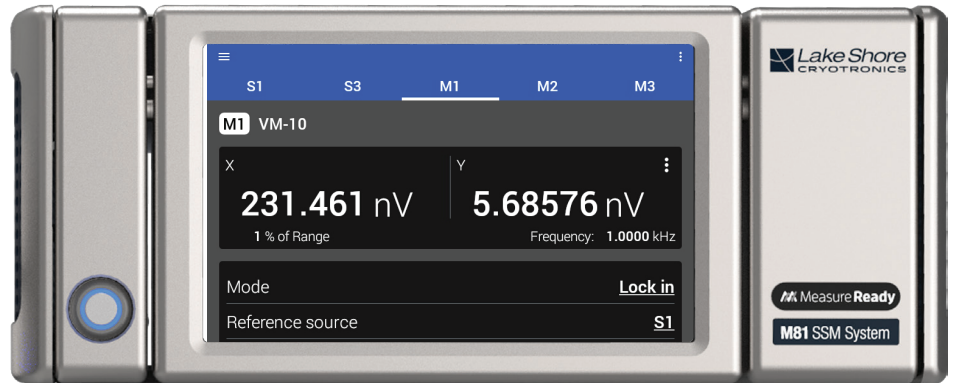

*Each screen is easily scrolled up and down to change parameters for whichever module you have selected*

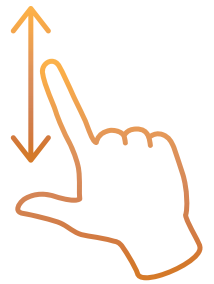
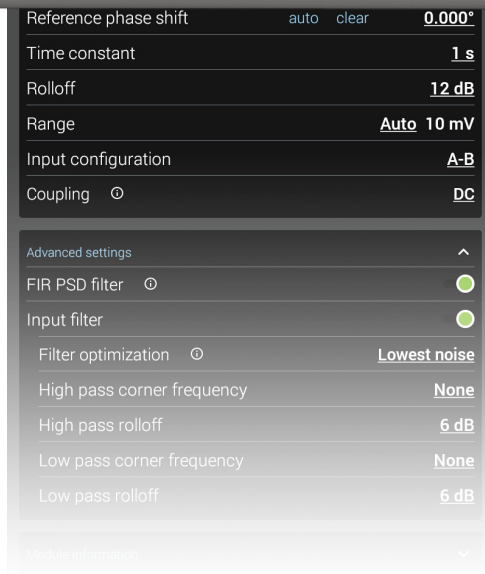

Made for the way you work today, the M81 features an uncluttered touch display with a unique TiltView™ screen, presenting a natural and engaging user interface.

With no confusing buttons or long learning curves, the M81 is intuitive and straightforward to operate. You'll quickly recognize the icons, gestures, and menu styles that follow familiar smartphone technology standards.

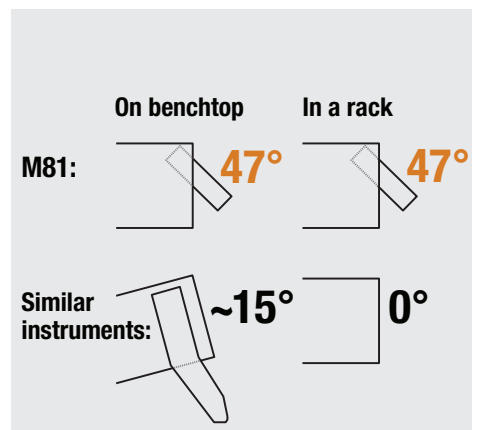
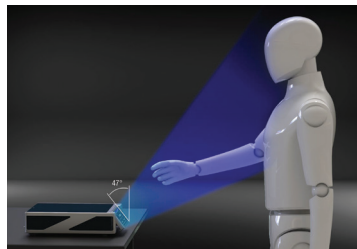

# M81-SSM and Lake Shore MeasureLINK™ software

Lake Shore MeasureLINK™ optional PC software is an easy, non-programming way to coordinate sophisticated electrical measurements as source or environment parameters change over time.

- Install application packs
  - They provide access to temperature, field, and electrical instrumentation drivers
- Build a system configuration that includes all of the instruments in the experiment
  - Monitor and control the instruments from the Monitor pane
- Build a sequence using drag-and-drop components to control temperature, field, and electrical parameter sweeps
- Collect data from the experiment and export it to your favorite analysis tool
- Need to build an experiment that isn't fully supported? No problem, simply make a similar drag-and-drop sequence and export it to a custom programming environment for final customizations. No problem is too complex to handle.



## The MeasureLINK interface

The screenshot displays the MeasureLINK software interface with the following components:

- Navigation pane:** Shows a sequence of steps including "Step 1 Iteration Loop", "Step 1.1 Discrete Temperature Loop", and "Step 1.1.1 Discrete Electrical Source Loop".
- Instrument Configuration workspace:** Contains settings for the "Discrete Electrical Source Loop", including:
  - Instrument: Ls155
  - Source mode: Voltage
  - Source shape: AC
  - Loop parameter: Amplitude
  - Loop spacing: Linear
  - Number of points: 11
  - Time delay: 50 ms
  - Amplitude: 0V to 0.01V
  - Frequency: 100Hz
  - DC offset: 0.01V
- Monitor pane:** Displays real-time data for various instruments:
  - System Status: Idle
  - 336 Temperature Controller ("Ls336Basic"): 12.000 K
  - Lake Shore 155 Source ("Ls155"): Off AC peak amplitude 10.00 mV, Range 100.0 mV, Frequency 100.0 Hz, DC offset 10.00 mV
  - M81 Source/Measure System ("M81"): Connected
  - M81 VM Voltage Measure ("M81Vm"): 3.3784 μV, 21.12 °, Reference frequency 100.0 Hz, Time constant 0.1 s
  - Mode: LIA, Range: 10 mV, Auto: DC, Coupling: AB

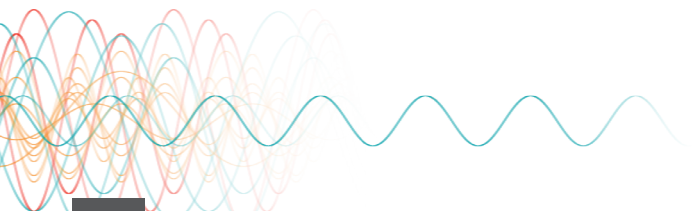



# MeasureLINK™ measurement sequence example

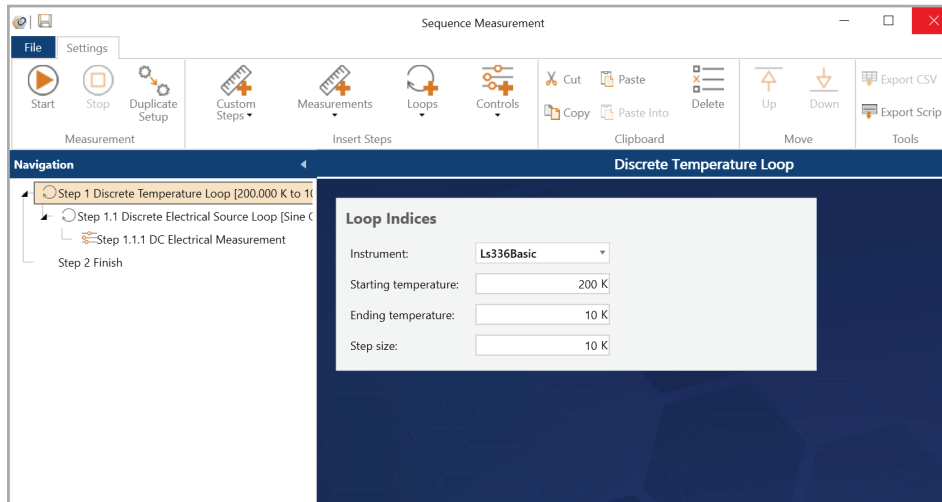

*In a temperature-dependent electrical measurement, Step 1 would be to set up a discrete temperature loop with start, end, and step temperature values.*

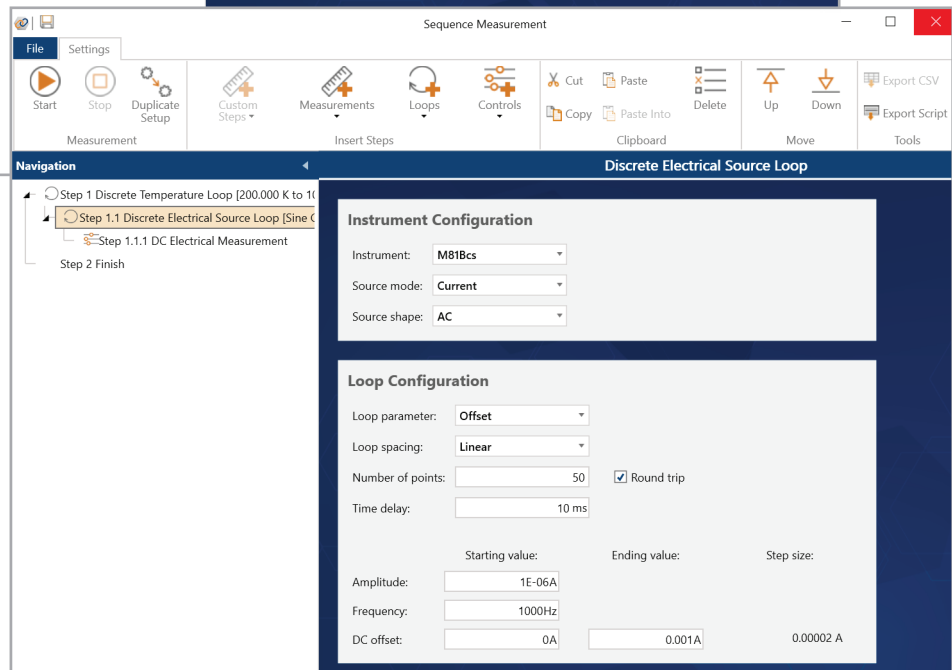

*Step 2: Configure the electrical source sweep, which includes specifying the instrument, source mode (voltage or current, source shape [DC or AC]), followed by the loop configuration parameters, such as sweep variable (amplitude, frequency, or offset) and related start, end, and step parameters.*

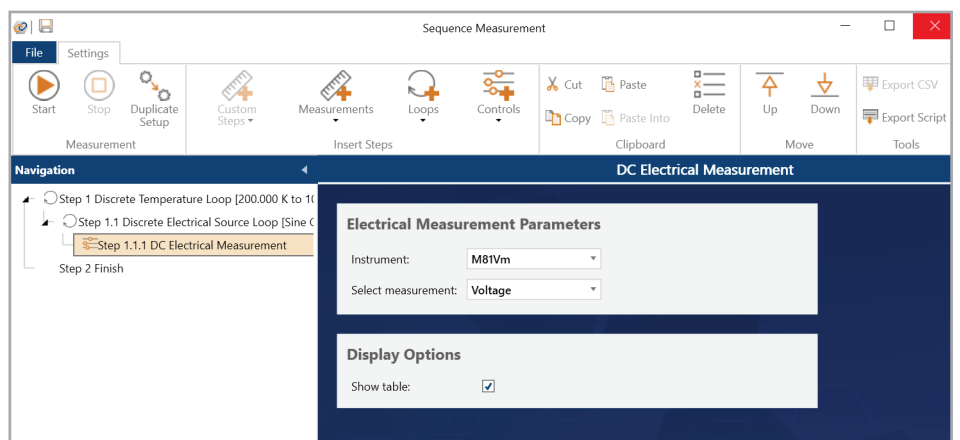

*Step 3: Add an electrical measurement step. Start execution and then collect the data in a table for easy export to your favorite analysis program.*

# The M81 instrument—the heart of the system

The heart of the M81-SSM is the instrument. Depending on the model ordered, the instrument supports a total of 2, 4, or 6 channels comprising 1, 2, or 3 sources and 1, 2, or 3 measures, respectively, as shown here:

| Instrument model | Maximum channel capacity | Number of source channels | Number of measure channels |
|------------------|--------------------------|---------------------------|----------------------------|
| M81-SSM-2        | 2                        | 1                         | 1                          |
| M81-SSM-4        | 4                        | 2                         | 2                          |
| M81-SSM-6        | 6                        | 3                         | 3                          |

Each M81 instrument can manage from 1 to 3 source channels and from 1 to 3 measure channels per half-rack for testing of multiple DUTs during a single test sequence without adding complexity and signal degradation from signal switching.

More than one instrument can also be combined to increase source and measure channel capabilities without degradation of analog performance while utilizing MeasureSync™ timing synchronization across all signal channels within the system.

Built on the Lake Shore MeasureReady™ instrument platform, the instrument features a graphical, touchscreen interface for both programming control and monitoring. Its ergonomically designed front panel features a TiltView™ display for best visibility, whether on a bench or mounted in a rack. It also supports standard LAN, USB, and GPIB communications.



Measure Ready M81 rear panel

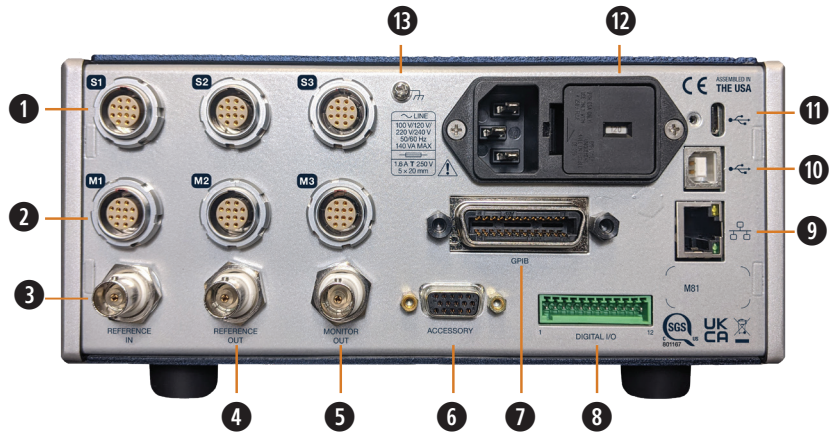

- ❶ LEMO source module connectors
- ❷ LEMO measure module connectors
- ❸ BNC reference input
- ❹ BNC reference output
- ❺ BNC monitor output
- ❻ DB15 accessory connector
- ❼ GPIB interface connector
- ❽ 12-pin digital I/O connector
- ❾ RJ-45 Ethernet interface
- ❿ USB communications interface
- ⓫ USB Type-C™ thumb drive interface
- ⓬ AC mains input connector and voltage selector/fuse module
- ⓭ Chassis ground connection

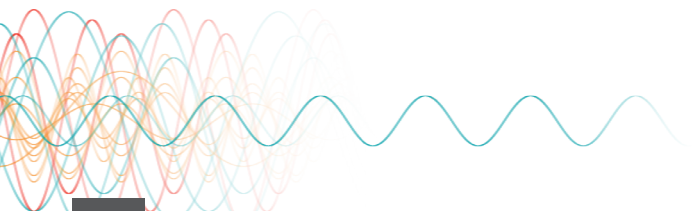

## M81 instrument specifications

Specifications are subject to change

### Source channels

|                                 |   |
|---------------------------------|---|
| <b>Source channel functions</b> | DC, sine, triangle (up to 5 kHz), square (up to 5 kHz)  |
| <b>Source sync functions</b>    | Synchronize to another channel or internal or external reference in   |
| <b>Frequency range</b>          | 100 $\mu$ Hz to 100 kHz (or module bandwidth, whichever is lesser)  |
| <b>Frequency resolution</b>     | Greater of 100 $\mu$ Hz, 6 digits   |
| <b>Frequency accuracy</b>       | 0.06%   |
| <b>Phase noise</b>              | 100 ms time constant, 12 dB/oct:<br>Internal reference: <0.0001° RMS at 10 kHz<br>External reference: <0.002° RMS at 10 kHz |
| <b>Dynamic reserve</b>          | >120 dB (typical, see manual)   |

### Measure channels

|                                  |  |
|----------------------------------|--|
| <b>Measure channel functions</b> | DC, AC (RMS, peak), or lock-in (X and Y, R and $\theta$ )  |
| <b>Lock-in reference</b>         | Any source channel, or external reference input  |
| <b>Reference in</b>              | BNC: sine $\geq 1$ V p – p $\geq 200$ Hz;<br>square $\geq 1$ V p – p $\geq 10$ mHz                                       |
| <b>Reference out</b>             | BNC: 3.3 V square  |
| <b>Monitor out</b>               | BNC: M1 monitor, M2 monitor, M3 monitor, manual output   |
| <b>Digital inputs</b>            | 6-pin 3.5 mm detachable terminal block:<br>2 TTL compatible inputs:<br>$V_{high}$ nominal: 3.3 V; $V_{low}$ nominal: 0 V |
| <b>Digital outputs</b>           | 6-pin 3.5 mm detachable terminal block:<br>2 TTL compatible outputs:<br>3.3 $V_{high}$ nominal at 1 mA                   |
| <b>Total harmonic distortion</b> | <0.1% from DC to 100 kHz, typical  |
| <b>Sample rate</b>               | 375 kSa/s  |
| <b>Warm-up time</b>              | 60 min to achieve specified accuracy   |
| <b>Isolation</b>                 | Measure common isolated from chassis ground  |
| <b>Front panel display</b>       | 5 in capacitive touch, color TFT-LCD WVGA (800 $\times$ 480) with LED back-light   |

### System speeds

|  | USB  | GPIB | Ethernet |
|--|------|------|----------|
| Data streaming maximum reading rate (records/s)            | 5000 | 5000 | 5000     |
| Data streaming maximum data throughput <sup>1</sup> (kB/s) | 20   | 40   | 80       |
| Typical SCPI query response time <sup>2</sup> (ms)         | 15   | 20   | 60       |

<sup>1</sup> Host PC dependent; speeds measured using PyVISA and Python 3 on Windows® 10 Intel® Core™ i7-8700 2.4-GHz CPU PC with 16 GB RAM

<sup>2</sup> 99% of queries are serviced faster than this interval

### Interface

#### IEEE-488.2 (GPIB)

|                        |   |
|------------------------|---|
| <b>Function</b>        | IEEE-488 command and control                      |
| <b>Capabilities</b>    | SH1, AH1, T5, L4, SR1, RL1, PPO, DC1, DT0, CO, E1 |
| <b>Data throughput</b> | Limited by 3 megabit internal bus rate            |

|                         |  |
|-------------------------|--|
| <b>Connector</b>        | IEEE-488 24-pin receptacle with M3.5 jack screws |
| <b>Software support</b> | LabVIEW™, Python, MeasureLINK, IVI.NET           |

#### USB host

|                  |                                       |
|------------------|---------------------------------------|
| <b>Type</b>      | USB 3.0 MSC device                    |
| <b>Function</b>  | Firmware updates, flash drive support |
| <b>Connector</b> | USB Type-C™                           |

#### USB device

|                         |   |
|-------------------------|---|
| <b>Type</b>             | USB 2.0   |
| <b>Function</b>         | Emulates a standard RS-232 serial port                |
| <b>Protocol</b>         | Standard commands for programmable instruments (SCPI) |
| <b>Baud rate</b>        | 921 600 Bd  |
| <b>Connector</b>        | USB Type-B  |
| <b>Software support</b> | LabVIEW, Python, MeasureLINK, IVI.NET                 |

#### Ethernet

|                           |   |
|---------------------------|---|
| <b>Function</b>           | TCP/IP command and control, mobile app                |
| <b>App layer protocol</b> | Standard commands for programmable instruments (SCPI) |
| <b>Connector</b>          | RJ-45   |
| <b>Speed</b>              | 1 Gb/s  |
| <b>Software support</b>   | LabVIEW, Python, MeasureLINK, IVI.NET                 |

### General

|                            |  |
|----------------------------|--|
| <b>Ambient temperature</b> | Rated accuracy $\pm 5$ °C of calibration temperature; 5 °C to 40 °C at reduced accuracy          |
| <b>Power requirement</b>   | 100 V, 120 V, 220 V, 240 V, $\pm 10\%$ , 50 or 60 Hz, 140 VA                                     |
| <b>Size</b>                | 216 mm W $\times$ 87 mm H $\times$ 369 mm D (8.5 in $\times$ 3.4 in $\times$ 14.5 in), half rack |
| <b>Weight</b>              | 5.7 kg (12.6 lb)   |
| <b>Approval</b>            | CE mark  |

### Available BNC adapter specifications

#### When used with S1, S2, or S3 source connections

|                                 |  |
|---------------------------------|--|
| <b>Range</b>                    | 10 V, fixed  |
| <b>Noise</b>                    | <1 $\mu$ V/ $\sqrt{\text{Hz}}$ at 1 kHz  |
| <b>Output impedance</b>         | 25 $\Omega$  |
| <b>Raw converter resolution</b> | 18 bits (76 $\mu$ V/LSB)   |
| <b>Temperature coefficient</b>  | 50 ppm/°C  |
| <b>Accuracy (typical)</b>       | 0.25% + 1 mV (1 year, $\pm 5$ °C from calibration temperature, after self calibration of instrument and within 24 h and $\pm 1$ °C, no calibration applicable to the cable itself) |

#### When used with M1, M2, or M3 measure connections

|                                 |  |
|---------------------------------|--|
| <b>Range</b>                    | 10 V, fixed  |
| <b>Noise</b>                    | <1 $\mu$ V/ $\sqrt{\text{Hz}}$ at 1 kHz  |
| <b>Input impedance</b>          | 10 M $\Omega$  |
| <b>Raw converter resolution</b> | 20 bits (19 $\mu$ V/LSB)   |
| <b>Temperature coefficient</b>  | 50 ppm/°C  |
| <b>Accuracy (typical)</b>       | 0.25% + 1 mV (1 year, $\pm 5$ °C from calibration temperature, after self calibration of instrument and within 24 h and $\pm 1$ °C, no calibration applicable to the cable itself) |

# SMU-10 source measure unit module



The source measure unit (SMU-10) is the latest module addition to the MeasureReady™ M81-SSM synchronous source measure system. It is specifically designed to handle the delicate nature of nano and ultra-cold samples with exceptionally low source noise and high measurement sensitivity. The SMU-10 offers both DC and AC capabilities and an integrated lock-in, providing a comprehensive suite of measurements tailored to advanced research applications.

## Three-terminal FET DC transfer curve

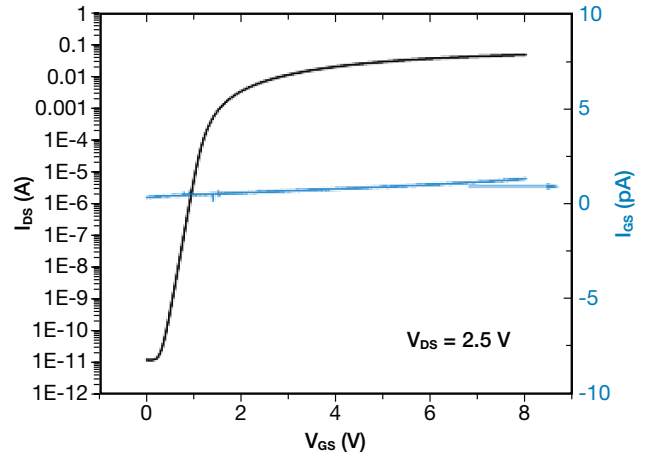

## Source/measure

When testing multi-terminal devices in a cryogenic probe station, use the M81-SSM with SMU-10 modules to apply voltage or current to the DUT and measure the corresponding current or voltage. The SMU's topology reduces the number of probe arms by half, significantly minimizing thermal impact. Set compliance limits to protect the DUT from accidental overloads.

## Advanced resistance

The M81-SSM's advanced resistance mode compensates for phase shifts caused by parasitic capacitance in cryogenic environments, ensuring more accurate resistance measurements. This technique reduces errors significantly, improving measurement accuracy.

## Four-wire voltage monitoring

Ideal for high-current devices. The Sense-HI and Sense-LO leads enable 4-wire measurements for built-in device voltage monitoring while sourcing currents.

## Synchronized sampling

Patented MeasureSync™ technology ensures perfect timing coordination for AC or DC measurements across multiple SMU-10 modules, eliminating data misalignment errors.

◀ *Minimize thermal impact by using SMU-10 modules with a probe station. In this example, the orange wire is the source, the light blue wire is the drain, the dark blue wire is the gate, and the black wire is the ground.*

Ultra-low noise    DC & AC capabilities    Integrated lock-in

## All-in-one precision tool

The SMU-10 integrates 6 instruments into a unified solution

| Measurement | Measure  | Source       |
|-------------|--|--------------|
| DC current  | Down to <100 fA  | Up to 100 mA |
| DC voltage  | Down to microvolts   | Up to 10 V   |
| AC current  | Sine (up to 100 kHz), triangle (up to 5 kHz), square (up to 5 kHz) |              |
| AC voltage  | Sine (up to 100 kHz), triangle (up to 5 kHz), square (up to 5 kHz) |              |
| Lock-in     | Down to nanovolts  | N/A          |
| Resistance  | Milliohms to 100 GΩ  |              |

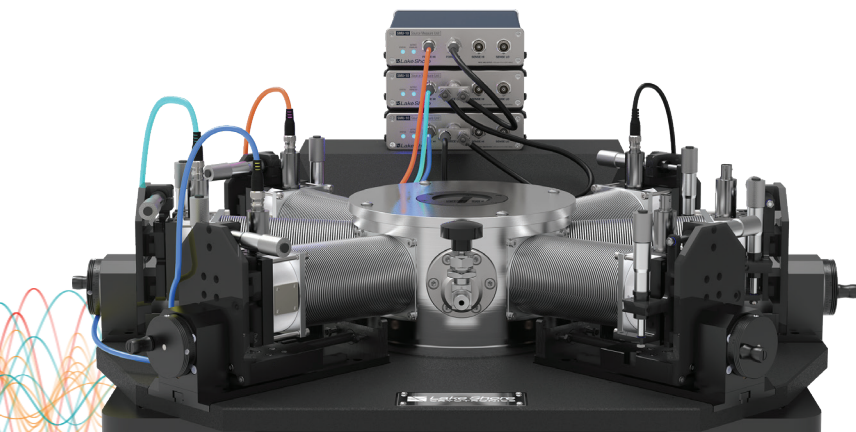

## SMU-10 specifications

Specifications are subject to change

| Voltage  | Current  |
|--|--|
| <b>Ranges:</b> 10 mV, 100 mV, 1 V, 10 V<br><b>Measure sensitivity:</b> <3 nV <sup>1</sup><br><b>Source noise (DC to 10 MHz):</b><br><0.2 mV RMS, <1.2 mV p-p (typical) | <b>Ranges:</b> 1 nA, 10 nA, 100 nA,<br>1 µA, 10 µA, 100 µA, 1 mA, 10 mA,<br>100 mA<br><b>Measure sensitivity:</b> <1 fA <sup>1</sup><br><b>DC output resistance:</b> >10 TΩ<br>(typical)<br><b>Source noise (DC to 10 MHz):</b><br><5 nA RMS, <25 nA p-p (typical) |



SMU-10 front view

**Overvoltage protection:** ±200 VDC

**Maximum power:** 1 W, 4-quadrant operation

**Magnetic field exposure:** Operational up to 50 mT DC

**Size:** 142 mm (5.58 in) W × 38.9 mm (1.53 in) H × 245 mm (9.63 in) L

## Noise

|                                | Range  | Source                      |                          | Measure                     |                          |
|--------------------------------|--------|-----------------------------|--------------------------|-----------------------------|--------------------------|
|                                |        | 0.1 Hz to 10 Hz             | 1 kHz                    | 0.1 Hz to 10 Hz             | 1 kHz                    |
| <b>Voltage noise (typical)</b> | 10 mV  | 250 nV RMS<br>(25 µV p-p)   | 30 nV/√Hz                | 250 nV RMS<br>(25 µV p-p)   | 30 nV/√Hz                |
|                                | 100 mV | 300 nV RMS<br>(2.75 µV p-p) | 35 nV/√Hz                | 300 nV RMS<br>(2.75 µV p-p) | 30 nV/√Hz                |
|                                | 1 V    | 550 nV RMS<br>(1.5 µV p-p)  | 35 nV/√Hz                | 550 nV RMS<br>(1.5 µV p-p)  | 40 nV/√Hz                |
|                                | 10 V   | 5 µV RMS<br>(1.25 µV p-p)   | 50 nV/√Hz                | 5 µV RMS<br>(1.25 µV p-p)   | 180 nV/√Hz               |
| <b>Current noise (typical)</b> | 1 nA   | 100 fA RMS<br>(500 fA p-p)  | 6 fA/√Hz<br>(at 10 Hz)   | 15 fA RMS<br>(75 fA p-p)    | 6 fA/√Hz<br>(at 10 Hz)   |
|                                | 10 nA  | 100 fA RMS<br>(500 fA p-p)  | 20 fA/√Hz<br>(at 100 Hz) | 45 fA RMS<br>(225 fA p-p)   | 20 fA/√Hz<br>(at 100 Hz) |
|                                | 100 nA | 300 fA RMS<br>(1.5 pA p-p)  | 60 fA/√Hz<br>(at 100 Hz) | 175 fA RMS<br>(875 fA p-p)  | 60 fA/√Hz<br>(at 100 Hz) |
|                                | 1 µA   | 1 pA RMS<br>(5 pA p-p)      | 200 fA/√Hz               | 1 pA RMS<br>(5 pA p-p)      | 200 fA/√Hz               |
|                                | 10 µA  | 5 pA RMS<br>(25 pA p-p)     | 1 pA/√Hz                 | 6 pA RMS<br>(30 pA p-p)     | 1 pA/√Hz                 |
|                                | 100 µA | 50 pA RMS<br>(250 pA p-p)   | 3 pA/√Hz                 | 60 pA RMS<br>(300 pA p-p)   | 2 pA/√Hz                 |
|                                | 1 mA   | 500 pA RMS<br>(2.5 nA p-p)  | 30 pA/√Hz                | 550 pA RMS<br>(2.75 nA p-p) | 20 pA/√Hz                |
|                                | 10 mA  | 5 nA RMS<br>(25 nA p-p)     | 300 pA/√Hz               | 5.5 nA RMS<br>(27.5 nA p-p) | 200 pA/√Hz               |
|                                | 100 mA | 50 nA RMS<br>(250 nA p-p)   | 3 nA/√Hz                 | 55 nA RMS<br>(1.375 µA p-p) | 2 nA/√Hz                 |

<sup>1</sup> 10 s time constant, 24 dB roll-off

## SMU-10 specifications

### Accuracy

|                  | Range  | Source                                |  | Measure                               |  |
|------------------|--------|---------------------------------------|--|---------------------------------------|--|
|                  |        | DC <sup>2</sup><br>± (% rdg + offset) | Lock-in <sup>2,3</sup><br>± (% rdg + offset) | DC <sup>2</sup><br>± (% rdg + offset) | Lock-in <sup>2,3</sup><br>± (% rdg + offset) |
| Voltage accuracy | 10 mV  | 0.15% + 300 µV                        | 0.15% + 50 nV                                | 0.15% + 300 µV                        | 0.15% + 50 nV                                |
|                  | 100 mV | 0.1% + 300 µV                         | 0.1% + 500 nV                                | 0.1% + 300 µV                         | 0.1% + 500 nV                                |
|                  | 1 V    | 0.05% + 600 µV                        | 0.05% + 5 µV                                 | 0.05% + 600 µV                        | 0.05% + 5 µV                                 |
|                  | 10 V   | 0.05% + 2 mV                          | 0.05% + 50 µV                                | 0.05% + 2 mV                          | 0.05% + 50 µV                                |
| Current accuracy | 1 nA   | 0.5% + 300 fA                         | 0.5% + 5 fA                                  | 0.5% + 300 fA                         | 0.5% + 5 fA                                  |
|                  | 10 nA  | 0.1% + 300 fA                         | 0.1% + 50 fA                                 | 0.1% + 300 fA                         | 0.1% + 50 fA                                 |
|                  | 100 nA | 0.1% + 300 pA                         | 0.1% + 500 fA                                | 0.1% + 300 pA                         | 0.1% + 500 fA                                |
|                  | 1 µA   | 0.1% + 300 pA                         | 0.1% + 5 pA                                  | 0.1% + 300 pA                         | 0.1% + 5 pA                                  |
|                  | 10 µA  | 0.05% + 3 nA                          | 0.05% + 50 pA                                | 0.05% + 3 nA                          | 0.05% + 50 pA                                |
|                  | 100 µA | 0.05% + 30 nA                         | 0.05% + 500 pA                               | 0.05% + 30 nA                         | 0.05% + 500 pA                               |
|                  | 1 mA   | 0.05% + 300 nA                        | 0.05% + 5 nA                                 | 0.05% + 300 nA                        | 0.05% + 5 nA                                 |
|                  | 10 mA  | 0.05% + 3 µA                          | 0.05% + 50 nA                                | 0.05% + 3 µA                          | 0.05% + 50 nA                                |
|                  | 100 mA | 0.05% + 10 µA                         | 0.05% + 500 nA                               | 0.05% + 10 µA                         | 0.05% + 500 nA                               |

### Settable resolution

|                             | Range  | Source |
|-----------------------------|--------|--------|
| Voltage settable resolution | 10 mV  | 100 nV |
|                             | 100 mV | 1 µV   |
|                             | 1 V    | 10 µV  |
|                             | 10 V   | 100 µV |
| Current settable resolution | 1 nA   | 10 fA  |
|                             | 10 nA  | 100 fA |
|                             | 100 nA | 1 pA   |
|                             | 1 µA   | 10 pA  |
|                             | 10 µA  | 100 pA |
|                             | 100 µA | 1 nA   |
|                             | 1 mA   | 10 nA  |
|                             | 10 mA  | 100 nA |
|                             | 100 mA | 1 µA   |

<sup>2</sup> Total system accuracy, 1 year and ±5 °C from Lake Shore calibration, 24 h and ±1 °C from self-calibration, 95% confidence

<sup>3</sup> DC to 1 kHz or 10% of source range bandwidth, whichever is lower

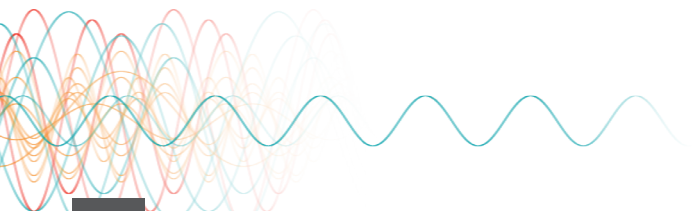

## SMU-10 specifications

### Temperature coefficient

|  | Range       | Source <sup>2,3</sup>                                | Measure <sup>2,3</sup>                          |
|--|-------------|--|---|
|  |             | $\pm$ (ppm rdg/ $^{\circ}$ C + offset/ $^{\circ}$ C) | $\pm$ (% rdg + offset)                          |
| Voltage temperature coefficient                | 10 mV       | 25 ppm/ $^{\circ}$ C + 5 $\mu$ V/ $^{\circ}$ C       | 25 ppm/ $^{\circ}$ C + 20 $\mu$ V/ $^{\circ}$ C |
|  | 100 mV      | 5 ppm/ $^{\circ}$ C + 5 $\mu$ V/ $^{\circ}$ C        | 10 ppm/ $^{\circ}$ C + 20 $\mu$ V/ $^{\circ}$ C |
|  | 1 V         | 5 ppm/ $^{\circ}$ C + 5 $\mu$ V/ $^{\circ}$ C        | 6 ppm/ $^{\circ}$ C + 20 $\mu$ V/ $^{\circ}$ C  |
|  | 10 V        | 5 ppm/ $^{\circ}$ C + 5 $\mu$ V/ $^{\circ}$ C        | 6 ppm/ $^{\circ}$ C + 100 $\mu$ V/ $^{\circ}$ C |
| Current temperature coefficient <sup>1,2</sup> | 1 nA        | 5 ppm/ $^{\circ}$ C + 2 pA/ $^{\circ}$ C             | 5 ppm/ $^{\circ}$ C + 0.5 pA/ $^{\circ}$ C      |
|  | 10 nA       | 5 ppm/ $^{\circ}$ C + 2 pA/ $^{\circ}$ C             | 5 ppm/ $^{\circ}$ C + 0.5 pA/ $^{\circ}$ C      |
|  | 100 nA      | 5 ppm/ $^{\circ}$ C + 2 pA/ $^{\circ}$ C             | 5 ppm/ $^{\circ}$ C + 0.5 pA/ $^{\circ}$ C      |
|  | 1 $\mu$ A   | 5 ppm/ $^{\circ}$ C + 3 pA/ $^{\circ}$ C             | 5 ppm/ $^{\circ}$ C + 1.5 pA/ $^{\circ}$ C      |
|  | 10 $\mu$ A  | 2 ppm/ $^{\circ}$ C + 10 pA/ $^{\circ}$ C            | 5 ppm/ $^{\circ}$ C + 1 pA/ $^{\circ}$ C        |
|  | 100 $\mu$ A | 2 ppm/ $^{\circ}$ C + 200 pA/ $^{\circ}$ C           | 2 ppm/ $^{\circ}$ C + 1 pA/ $^{\circ}$ C        |
|  | 1 mA        | 2 ppm/ $^{\circ}$ C + 500 pA/ $^{\circ}$ C           | 2 ppm/ $^{\circ}$ C + 20 pA/ $^{\circ}$ C       |
|  | 10 mA       | 2 ppm/ $^{\circ}$ C + 10 nA/ $^{\circ}$ C            | 2 ppm/ $^{\circ}$ C + 5 nA/ $^{\circ}$ C        |
|  | 100 mA      | 2 ppm/ $^{\circ}$ C + 100 nA/ $^{\circ}$ C           | 5 ppm/ $^{\circ}$ C + 10 nA/ $^{\circ}$ C       |

### Impedance and bandwidth

|         | Range       | Impedance       |   | Bandwidth (typical) |          |
|---------|-------------|-----------------|---|---------------------|----------|
|         |             | Input           | Output                                  | Source              | Measure  |
| Voltage | 10 mV       | 0.6 $\Omega$    | >100 G $\Omega$ (typical, remote sense) | 60 kHz              | 60 kHz   |
|         | 100 mV      |                 |   |                     |          |
|         | 1 V         |                 |   |                     |          |
|         | 10 V        |                 |   |                     |          |
| Current | 1 nA        | >10 T $\Omega$  | 100 k $\Omega$                          | 100 Hz              | 350 Hz   |
|         | 10 nA       | >1 T $\Omega$   | 10 k $\Omega$                           | 500 Hz              | 1.1 kHz  |
|         | 100 nA      | >100 G $\Omega$ | 1 k $\Omega$                            | 1 kHz               | 2 kHz    |
|         | 1 $\mu$ A   | >10 G $\Omega$  | 100 $\Omega$                            | 4 kHz               | 10 kHz   |
|         | 10 $\mu$ A  | >1 G $\Omega$   | 10 $\Omega$                             | 10 kHz              | 25 kHz   |
|         | 100 $\mu$ A | >100 M $\Omega$ | 1 $\Omega$                              | 50 kHz              | 65 kHz   |
|         | 1 mA        | >10 M $\Omega$  | 100 m $\Omega$                          | 100 kHz             | >100 kHz |
|         | 10 mA       | >1 M $\Omega$   | 20 m $\Omega$                           | 100 kHz             | >100 kHz |
|         | 100 mA      | >100 k $\Omega$ | 10 m $\Omega$                           | 100 kHz             | >100 kHz |

# VM-10 voltage measure module

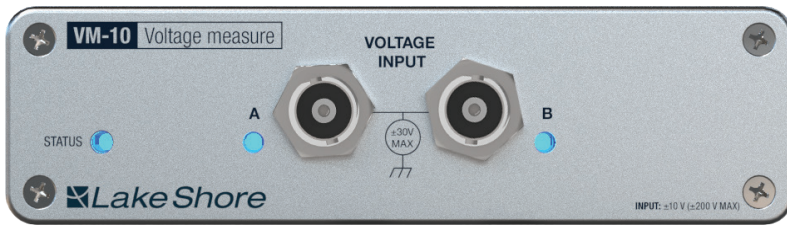

This module provides voltage measurements with resolution from low nanovolts up to 10 V from DC to 100 kHz, including amplitude, phase, and harmonic detection capabilities. Proprietary seamless ranging technology allows continuous measurements when increasing or decreasing ranges. This patented capability significantly reduces or eliminates the typical range change-induced measurement offsets/discontinuities commonly seen in signal sweeping applications requiring numerous range changes. It's particularly useful when measuring I-V curves involving many data points and range changes and can reduce overall measurement time.

Voltage noise performance is on par with modern AC lock-in amplifier instruments but packaged in a compact, easy-to-use, remote-mountable module that can be located next to the sample or DUT to minimize cabling signal losses and noise pickup.

In addition, the module offers two configurable hardware low-pass and high-pass filters, which enable highly sensitive low-level measurements to be made in the presence of significant interfering signals. The inclusion of user-configurable hardware filters combined with the high-gain, low-noise front-end module amplifier design can eliminate the need for additional pre-amplifiers often required with traditional lock-in amplifiers. It also offers user-selectable single-ended or differential input connections providing additional options for minimizing noise and ground loop interference without the use of external converters or adapters.

Up to three simultaneously connected VM-10 modules can be used with each M81 instrument. Each module can be independently configured to perform DC, AC, or lock-in measurements.

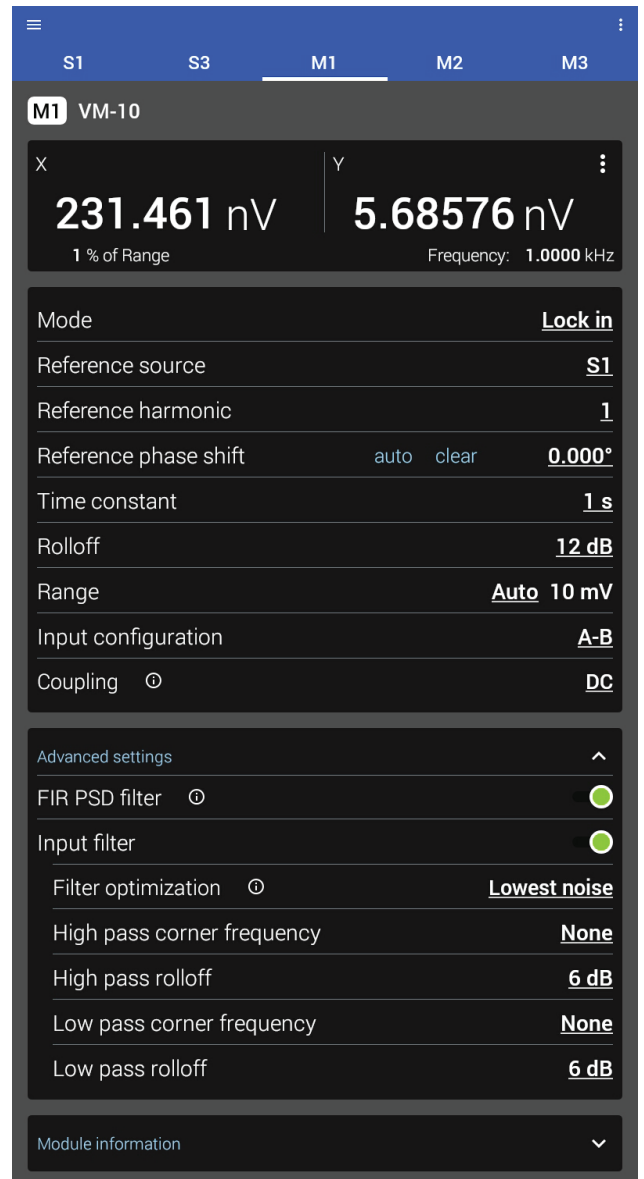



## VM-10 specifications

Specifications are subject to change

|                                |  |
|--------------------------------|--|
| <b>Input configuration</b>     | Single-ended (A) or differential (A-B)   |
| <b>Input coupling</b>          | DC or AC (0.1 Hz)  |
| <b>Ranges</b>                  | 10 V, 1 V, 100 mV, 10 mV; seamless, automatic transitions  |
| <b>Best sensitivity</b>        | <1 nV <sup>1</sup>   |
| <b>Hardware filters</b>        | LP: 10 Hz, 30 Hz, 100 Hz, 300 Hz, 1 kHz, 3 kHz, 10 kHz; 20 dB or 40 dB/decade<br>HP: 10 Hz, 30 Hz, 100 Hz, 300 Hz, 1 kHz, 3 kHz; 20 dB or 40 dB/decade<br>Modes: High reserve, Low-noise |
| <b>Typical input impedance</b> | >1 TΩ, 120 pF (DC coupled)   |
| <b>Leakage current</b>         | <15 pA   |
| <b>CMRR</b>                    | 80 dB up to 1 kHz  |
| <b>Magnetic field exposure</b> | Operational up to 8 mT DC  |
| <b>Size</b>                    | 142 mm W × 39 mm H × 89 mm D (5.6 in × 1.5 in × 3.5 in)  |

### Bandwidth/accuracy

| Range  | Bandwidth<br>(-3 dB,<br>typical) | Single-ended operation         |                                       |   | Differential operation         |                                       |   |
|--------|----------------------------------|--------------------------------|---------------------------------------|---|--------------------------------|---------------------------------------|---|
|        |                                  | DC <sup>2</sup><br>±(%rdg + V) | Lock-in <sup>2,3,4</sup><br>±%rdg + V | Temperature<br>coefficient <sup>2,3</sup><br>±(ppm rdg/°C + V/°C) | DC <sup>2</sup><br>±(%rdg + V) | Lock-in <sup>2,3,4</sup><br>±%rdg + V | Temperature<br>coefficient <sup>2,3</sup><br>±(ppm rdg/°C + V/°C) |
| 10 V   | >100 kHz                         | 0.025% + 600 μV                | 0.025% +<br>50 μV                     | 6 ppm/°C + 24 μV/°C   | 0.025% + 150 μV                | 0.025% +<br>50 μV                     | 6 ppm/°C + 6 μV/°C  |
| 1 V    | >100 kHz                         | 0.025% + 21 μV                 | 0.025% +<br>5 μV                      | 6 ppm/°C + 20 μV/°C   | 0.025% + 10 μV                 | 0.025% +<br>5 μV                      | 6 ppm/°C + 2 μV/°C  |
| 100 mV | 75 kHz                           | 0.1% + 20 μV                   | 0.1% +<br>500 nV                      | 120 ppm/°C +<br>20 μV/°C  | 0.05% + 6 μV                   | 0.05% +<br>500 nV                     | 6 ppm/°C + 1 μV/°C  |
| 10 mV  | 75 kHz                           | 0.1% + 20 μV                   | 0.1% +<br>50 nV                       |   | 0.05% + 6 μV                   | 0.05% +<br>50 nV                      |   |

### Noise (typical)

Current noise at 1 kHz: 20 fA/√Hz

Voltage noise measured with filters off, inputs shorted

| Range  | Single-ended operation    |  | Differential operation    |  |
|--------|---------------------------|--|---------------------------|--|
|        | Voltage noise<br>at 1 kHz | Voltage noise<br>at 0.1 Hz<br>to 10 Hz | Voltage noise<br>at 1 kHz | Voltage noise<br>at 0.1 Hz<br>to 10 Hz |
| 10 V   | 170 nV/√Hz                | 4 μV RMS; 20 μV p-p                    | 170 nV/√Hz                | 4 μV RMS; 20 μV p-p                    |
| 1 V    | 50 nV/√Hz                 | 400 nV RMS; 2 μV p-p                   | 50 nV/√Hz                 | 500 nV RMS; 2.5 μV p-p                 |
| 100 mV | 3.8 nV/√Hz                | 50 nV RMS; 250 nV p-p                  | 4.5 nV/√Hz                | 60 nV RMS; 300 nV p-p                  |
| 10 mV  | 3.2 nV/√Hz                | 25 nV RMS; 125 nV p-p                  | 4.1 nV/√Hz                | 30 nV RMS; 150 nV p-p                  |

<sup>1</sup> Lock-in measurement, 10 mV range, 10 s time constant, 24 dB rolloff, 95% confidence interval

<sup>2</sup> Total system accuracy, 95% confidence, 1 year and ±5 °C from Lake Shore calibration, 24 h and ±1 °C from self-calibration, filters off

<sup>3</sup> DC to 1 kHz

<sup>4</sup> Add 0.1% of reading when AC coupled

# BCS-10 balanced current source module



This module provides programmable currents from 1 pA to 100 mA with a  $\pm 10$  V maximum compliance output from DC to 100 kHz sinusoidal output. Derived from Lake Shore's industry-leading Model 372 AC resistance bridge, the BCS-10 employs a differential or balanced design that helps reduce or eliminate ground loops often encountered in cryostats and other research apparatus. It expands on Model 372 balanced source capability, adding variable frequency and amplitude programmability for enhanced flexibility while maintaining excellent noise performance.

The inclusion of a virtual center-point ground connection further enhances noise performance by allowing the user to determine optimal center-point tie points within given apparatus or equipment setups. The BCS-10 is designed to be paired with the VM-10 module, which provides both single-ended and differential (balanced) input connection and modes. The true differential (balanced) wiring configuration minimizes noise coupled from the environment, such as from power lines, lighting, motors, and other lab equipment.

A typical application of the balanced current source involves low-resistance measurements, where the resistance of the wires connecting the current source to a sensor may be significant. Any unbalance in lead wire resistance results in a common-mode voltage that complicates the measurement of the desired parameter, the voltage across the sensor. The external CMR feature is unique in that it allows the BCS-10 to force some remote node (such as a VM-10 input) to circuit common potential and thus mitigate the effect of unbalanced lead wire resistance.

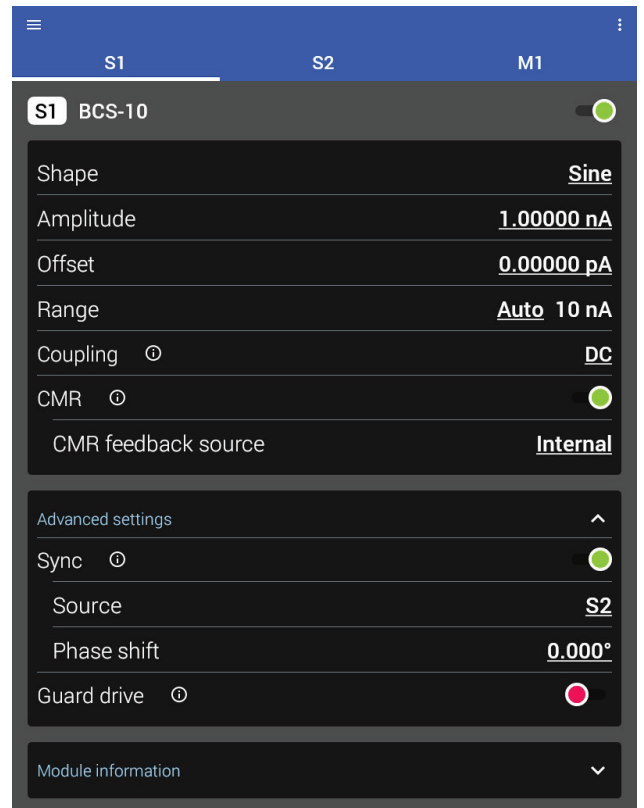

## BCS-10 specifications

Specifications are subject to change

|                                |  |
|--------------------------------|--|
| <b>Ranges</b>                  | 100 mA, 10 mA, 1 mA, 100 $\mu$ A, 10 $\mu$ A, 1 $\mu$ A, 100 nA, 10 nA; automatic selection                    |
| <b>Compliance</b>              | 20 V differential, 10 V single-ended (non-settable)  |
| <b>Maximum power</b>           | 1 W, 4-quadrant operation  |
| <b>CMR modes</b>               | Off, internal, external  |
| <b>Coupling</b>                | DC or AC (1 Hz)  |
| <b>Guard drive</b>             | Enable or disable  |
| <b>Rise time</b>               | <25 $\mu$ s, 10% to 90%, zero to full scale, <1 $\Omega$ impedance load, 1 $\mu$ A and above ranges            |
| <b>Settle time</b>             | <60 $\mu$ s to 0.1% of final value, zero to full scale, <1 $\Omega$ impedance load, 1 $\mu$ A and above ranges |
| <b>Load impedance</b>          | Stability maintained with reactive loads up to 50 $\mu$ F or 1 mH (with 100 $\Omega$ damping)                  |
| <b>Magnetic field exposure</b> | Operational up to 11 mT DC   |
| <b>Size</b>                    | 142 mm W $\times$ 39 mm H $\times$ 89 mm D (5.6 in $\times$ 1.5 in $\times$ 3.5 in)                            |

### Bandwidth/accuracy

| Range       | Bandwidth (typical) |                                 | DC <sup>1</sup><br>$\pm$ (% rdg + A) | Lock-in <sup>1,2</sup><br>$\pm$ % rdg + A | Temperature coefficient <sup>1,2</sup><br>$\pm$ (ppm rdg/ $^{\circ}$ C + A/ $^{\circ}$ C) | Settable resolution |
|-------------|---------------------|---------------------------------|--------------------------------------|---|---|---------------------|
|             | Maximum frequency   | Full accuracy maximum frequency |                                      |   |   |                     |
| 100 mA      | 100 kHz             | 1 kHz                           | 0.03% + 5 $\mu$ A                    | 0.15% + 500 nA                            | 2 ppm/ $^{\circ}$ C + 100 nA/ $^{\circ}$ C  | 1 $\mu$ A           |
| 10 mA       | 100 kHz             | 1 kHz                           | 0.03% + 500 nA                       | 0.15% + 50 nA                             | 2 ppm/ $^{\circ}$ C + 10 nA/ $^{\circ}$ C   | 100 nA              |
| 1 mA        | 100 kHz             | 1 kHz                           | 0.03% + 50 nA                        | 0.15% + 5 nA                              | 2 ppm/ $^{\circ}$ C + 500 pA/ $^{\circ}$ C  | 10 nA               |
| 100 $\mu$ A | 100 kHz             | 1 kHz                           | 0.03% + 5 nA                         | 0.15% + 500 pA                            | 2 ppm/ $^{\circ}$ C + 200 pA/ $^{\circ}$ C  | 1 nA                |
| 10 $\mu$ A  | 100 kHz             | 1 kHz                           | 0.03% + 1 nA                         | 0.15% + 50 pA                             | 2 ppm/ $^{\circ}$ C + 10 pA/ $^{\circ}$ C   | 100 pA              |
| 1 $\mu$ A   | 10 kHz              | 1 kHz                           | 0.5% + 120 pA                        | 0.5% + 5 pA                               | 5 ppm/ $^{\circ}$ C + 2 pA/ $^{\circ}$ C  | 10 pA               |
| 100 nA      | 1 kHz               | 100 Hz                          | 0.5% + 60 pA                         | 0.5% + 500 fA                             | 5 ppm/ $^{\circ}$ C + 2 pA/ $^{\circ}$ C  | 1 pA                |
| 10 nA       | 100 Hz              | 30 Hz                           | 0.5% + 30 pA                         | 0.5% + 50 fA                              | 5 ppm/ $^{\circ}$ C + 2 pA/ $^{\circ}$ C  | 100 fA              |

### Noise (typical)

| Range       | Noise density                       | Noise at 0.1 Hz to 10 Hz |
|-------------|-------------------------------------|--------------------------|
| 100 mA      | 1.2 nA/ $\sqrt{\text{Hz}}$ at 1 kHz | 10 nA RMS (50 nA p-p)    |
| 10 mA       | 200 pA/ $\sqrt{\text{Hz}}$ at 1 kHz | 2 nA RMS (10 nA p-p)     |
| 1 mA        | 20 pA/ $\sqrt{\text{Hz}}$ at 1 kHz  | 400 pA RMS (2 nA p-p)    |
| 100 $\mu$ A | 2.5 pA/ $\sqrt{\text{Hz}}$ at 1 kHz | 50 pA RMS (250 pA p-p)   |
| 10 $\mu$ A  | 450 fA/ $\sqrt{\text{Hz}}$ at 1 kHz | 1.5 pA RMS (7.5 pA p-p)  |
| 1 $\mu$ A   | 150 fA/ $\sqrt{\text{Hz}}$ at 1 kHz | 600 fA RMS (3 pA p-p)    |
| 100 nA      | 50 fA/ $\sqrt{\text{Hz}}$ at 100 Hz | 200 fA RMS (1 pA p-p)    |
| 10 nA       | 20 fA/ $\sqrt{\text{Hz}}$ at 10 Hz  | 150 fA RMS (750 fA p-p)  |

### DC output impedance

| Range       | Magnitude output impedance |
|-------------|----------------------------|
| 100 mA      | >100 k $\Omega$            |
| 10 mA       | >1 M $\Omega$              |
| 1 mA        | >10 M $\Omega$             |
| 100 $\mu$ A | >100 M $\Omega$            |
| 10 $\mu$ A  | >1 G $\Omega$              |
| 1 $\mu$ A   | >10 G $\Omega$             |
| 100 nA      | >100 G $\Omega$            |
| 10 nA       | >100 G $\Omega$            |

<sup>1</sup> Total system, 1 year and  $\pm 5$   $^{\circ}$ C from Lake Shore calibration, 24 h and  $\pm 1$   $^{\circ}$ C from self-calibration, 95% confidence

<sup>2</sup> DC to full accuracy frequency

# CM-10 current measure module

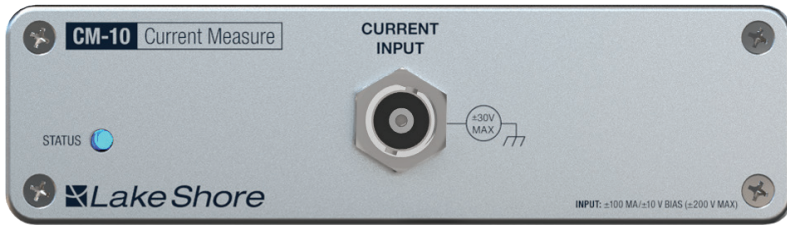

This module provides current measurements with near-zero input offset voltage from fA levels up to 100 mA from DC to 100 kHz, including amplitude, phase, and harmonic detection capabilities. The module also has configurable hardware and software filtering.

Current noise performance is on par with modern TIA and DC picoammeters, and the module also includes a programmable  $\pm 10$  V voltage bias offset feature for materials or devices that require biased current measurements or operation, such as a photodiode.

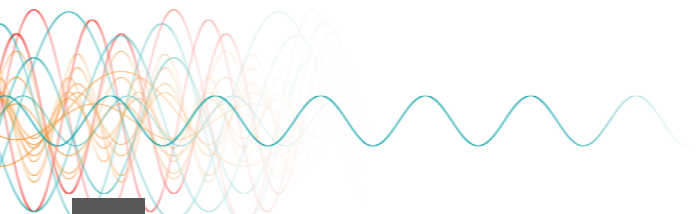
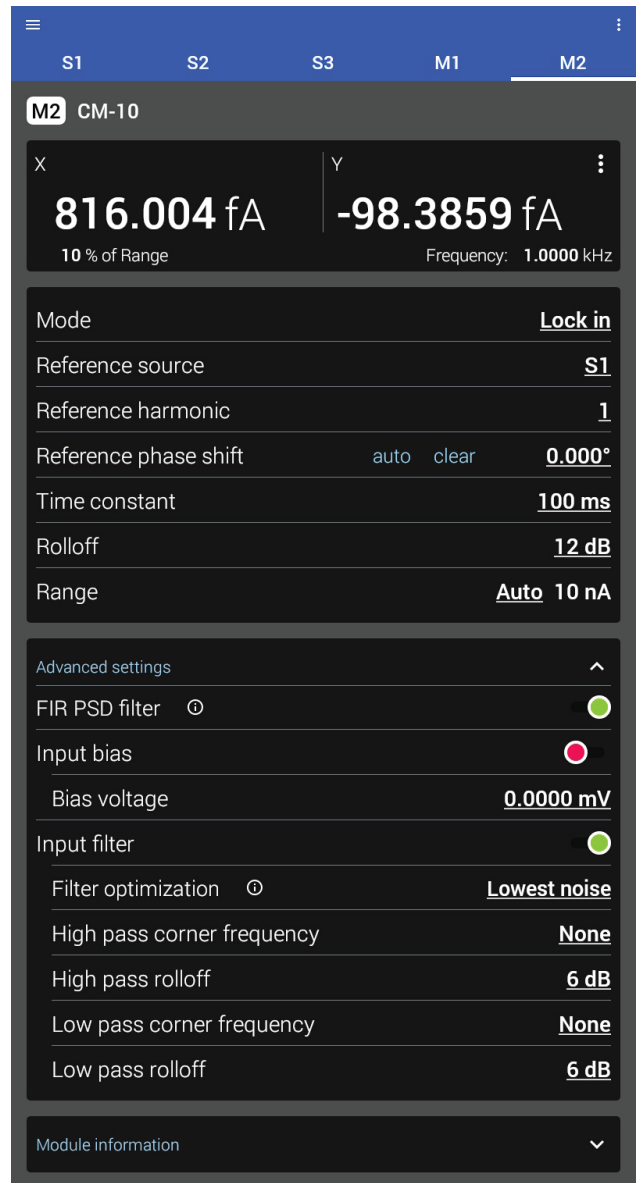

## CM-10 specifications

Specifications are subject to change

|   |  |
|---|--|
| <b>Ranges</b>                           | 100 mA, 10 mA, 1 mA, 100 $\mu$ A, 10 $\mu$ A, 1 $\mu$ A, 100 nA, 10 nA, 1 nA; automatic transitions  |
| <b>Input offset voltage<sup>2</sup></b> | <150 $\mu$ V   |
| <b>Settable bias voltage</b>            | $\pm$ 10 V   |
| <b>Bias voltage settable resolution</b> | 320 $\mu$ V  |
| <b>Best sensitivity</b>                 | <10 fA <sup>1</sup>  |
| <b>Hardware filters</b>                 | LP: 10 Hz, 30 Hz, 100 Hz, 300 Hz, 1 kHz, 3 kHz, 10 kHz; 20 dB or 40 dB/decade<br>HP: 10 Hz, 30 Hz, 100 Hz, 300 Hz, 1 kHz, 3 kHz; 20 dB or 40 dB/decade<br>Modes: High reserve, Low-noise |
| <b>Magnetic field exposure</b>          | Operational up to 3 mT DC  |
| <b>Max input capacitance to ground</b>  | 100 nF   |
| <b>Size</b>                             | 142 mm W $\times$ 39 mm H $\times$ 89 mm D (5.6 in $\times$ 1.5 in $\times$ 3.5 in)  |

### Bandwidth/accuracy

| Range       | Bandwidth (-3 dB, typical) | Full accuracy | DC <sup>2</sup><br>$\pm$ (% rdg + A) | Lock-in <sup>2,3</sup><br>$\pm$ % rdg + A | Temperature coefficient <sup>2,3</sup><br>$\pm$ (% rdg/ $^{\circ}$ C + A/ $^{\circ}$ C) |
|-------------|----------------------------|---------------|--------------------------------------|---|---|
| 100 mA      | >100 kHz                   | 1 kHz         | 0.05% + 1 $\mu$ A                    | 0.05% + 500 nA                            | 5 ppm/ $^{\circ}$ C + 50 nA/ $^{\circ}$ C   |
| 10 mA       | >100 kHz                   | 1 kHz         | 0.05% + 100 nA                       | 0.05% + 50 nA                             | 2 ppm/ $^{\circ}$ C + 5 nA/ $^{\circ}$ C  |
| 1 mA        | >100 kHz                   | 1 kHz         | 0.05% + 10 nA                        | 0.05% + 5 nA                              | 2 ppm/ $^{\circ}$ C + 500 pA/ $^{\circ}$ C  |
| 100 $\mu$ A | 40 kHz                     | 1 kHz         | 0.05% + 1 nA                         | 0.05% + 500 pA                            | 2 ppm/ $^{\circ}$ C + 50 pA/ $^{\circ}$ C   |
| 10 $\mu$ A  | 8 kHz                      | 500 Hz        | 0.05% + 500 pA                       | 0.05% + 50 pA                             | 5 ppm/ $^{\circ}$ C + 5 pA/ $^{\circ}$ C  |
| 1 $\mu$ A   | 2.2 kHz                    | 100 Hz        | 0.05% + 500 pA                       | 0.1% + 5 pA                               | 5 ppm/ $^{\circ}$ C + 0.5 pA/ $^{\circ}$ C  |
| 100 nA      | 450 Hz                     | 20 Hz         | 0.05% + 10 pA                        | 0.1% + 500 fA                             | 5 ppm/ $^{\circ}$ C + 0.5 pA/ $^{\circ}$ C  |
| 10 nA       | 80 Hz                      | 10 Hz         | 0.1% + 5 pA                          | 0.5% + 50 fA                              | 50 ppm/ $^{\circ}$ C + 0.5 pA/ $^{\circ}$ C   |
| 1 nA        | 80 Hz                      | 10 Hz         | 0.1% + 5 pA                          | 0.5% + 5 fA                               | 50 ppm/ $^{\circ}$ C + 0.5 pA/ $^{\circ}$ C   |

### Noise (typical)

| Range       | Noise density <sup>4</sup>  | Noise at 0.1 Hz to 10 Hz <sup>4</sup> |
|-------------|-----------------------------|---------------------------------------|
| 100 mA      | 2.6 nA/ $\sqrt$ Hz at 1 kHz | 35 nA RMS (175 nA p-p)                |
| 10 mA       | 250 pA/ $\sqrt$ Hz at 1 kHz | 4 nA RMS (20 nA p-p)                  |
| 1 mA        | 30 pA/ $\sqrt$ Hz at 1 kHz  | 350 pA RMS (1.75 nA p-p)              |
| 100 $\mu$ A | 3.5 pA/ $\sqrt$ Hz at 1 kHz | 30 pA RMS (150 nA p-p)                |
| 10 $\mu$ A  | 500 fA/ $\sqrt$ Hz at 1 kHz | 4 pA RMS (20 pA p-p)                  |
| 1 $\mu$ A   | 70 fA/ $\sqrt$ Hz at 1 kHz  | 400 fA RMS (2 pA p-p)                 |
| 100 nA      | 13 fA/ $\sqrt$ Hz at 100 Hz | 60 fA RMS (300 fA p-p)                |
| 10 nA       | 4.3 fA/ $\sqrt$ Hz at 77 Hz | 16 fA RMS (80 fA p-p)                 |
| 1 nA        | 4.3 fA/ $\sqrt$ Hz at 77 Hz | 16 fA RMS (80 fA p-p)                 |

### DC input impedance

| Range       | DC input impedance |
|-------------|--------------------|
| 100 mA      | 200 m $\Omega$     |
| 10 mA       | 200 m $\Omega$     |
| 1 mA        | 200 m $\Omega$     |
| 100 $\mu$ A | 1 $\Omega$         |
| 10 $\mu$ A  | 5 $\Omega$         |
| 1 $\mu$ A   | 50 $\Omega$        |
| 100 nA      | 50 $\Omega$        |
| 10 nA       | 500 $\Omega$       |
| 1 nA        | 5 k $\Omega$       |

<sup>1</sup> 1 nA range, 10 s, 95% confidence interval

<sup>2</sup> Total system accuracy, 1 year and  $\pm$ 5  $^{\circ}$ C from Lake Shore calibration; 24 h,  $\pm$ 1  $^{\circ}$ C from self-calibration, 95% confidence, filters off

<sup>3</sup> DC to full accuracy frequency

<sup>4</sup> In Low noise mode; High reserve mode will have the noise of the next higher current range

# VS-10 voltage source module



This module provides programmable voltages from  $\pm 1$  nV to  $\pm 10$  V with a maximum of 100 mA compliance from DC to 100 kHz sinusoidal output. The VS-10 is useful for gate biasing, voltage sweep I-V curve profiling, and applications that require highly stable voltages in combination with current, resistance/conductance, and other material or electronic device measurements.

Patented circuitry enables separate ranges and amplitude settings for DC and AC signal components. This technology benefits device measurements that require both DC voltage bias and small signal AC characterization stimulus. This is because a single VS-10 module operates equivalent to two separate single-function DC and AC voltage sources. It allows for simultaneous DC biasing and sweeping as well as combined AC signals to be superimposed for sample and device stimulus and selective measurement by corresponding and synchronized VM-10 modules. This hybrid DC+AC signal capability can reduce or eliminate the need and complexity for dedicated DC and AC sources while providing enhanced characterization capabilities and richer measurement data and sample insights.

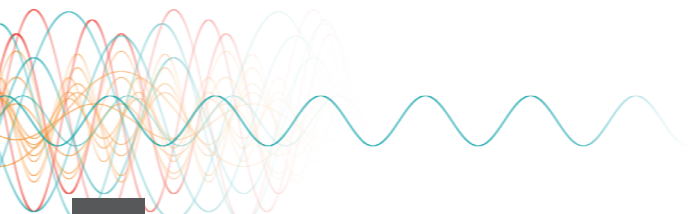
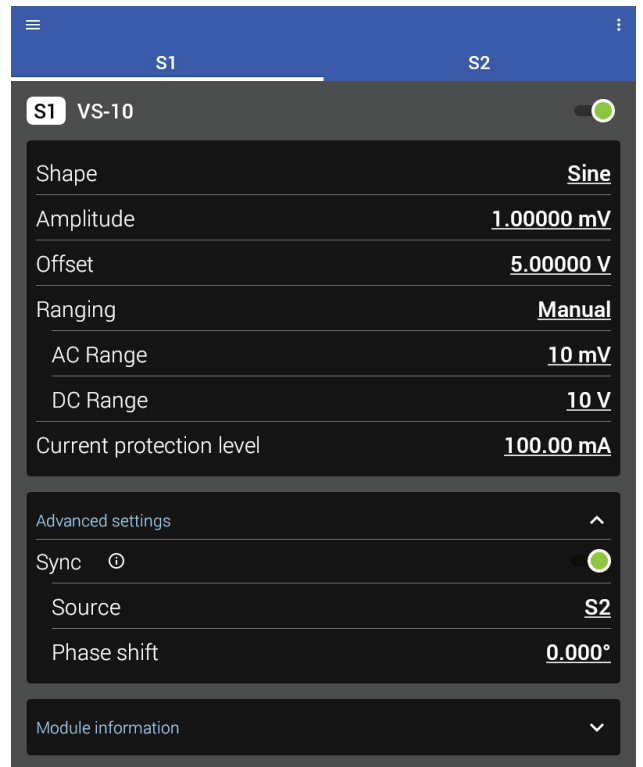

## VS-10 specifications

Specifications are subject to change

|                                |   |
|--------------------------------|---|
| <b>Ranges</b>                  | V: 10 V, 1 V, 100 mV, 10 mV; AC and DC ranges can be independently set; automatic selection       |
| <b>Current limit</b>           | Settable up to 100 mA (DC only)   |
| <b>Maximum power</b>           | 1 W, 4-quadrant operation   |
| <b>Output impedance</b>        | <150 mΩ   |
| <b>Rise time</b>               | <5 μs, 10% to 90%, negative to positive full scale, >10 MΩ impedance load, all ranges             |
| <b>Settle time</b>             | <10 μs to 0.1% of final value, negative to positive full scale, >10 MΩ impedance load, all ranges |
| <b>Load impedance</b>          | Stability maintained with reactive loads up to 50 μF or 1 mH (with 100 Ω damping)                 |
| <b>Magnetic field exposure</b> | Operational up to 50 mT DC  |
| <b>Size</b>                    | 142 mm W × 39 mm H × 89 mm D (5.6 in × 1.5 in × 3.5 in)   |

### Bandwidth/accuracy

| Range <sup>1</sup> | Bandwidth (-3 dB, typical) | DC <sup>2</sup><br>±(% rdg + V) | Lock-in <sup>2,3</sup><br>±% rdg + V | Temperature coefficient <sup>2,3</sup><br>±(ppm rdg/°C + V/°C) | DC settable resolution <sup>4</sup> | AC settable resolution |
|--------------------|----------------------------|---------------------------------|--------------------------------------|--|-------------------------------------|------------------------|
| 10 V               | 95 kHz                     | 0.025% + 450 μV                 | 0.025% + 50 μV                       | 5 ppm/°C + 5 μV/°C   | 3 μV                                | 100 μV                 |
| 1 V                | 95 kHz                     | 0.05% + 450 μV                  | 0.05% + 5 μV                         | 5 ppm/°C + 5 μV/°C   | 1 μV                                | 10 μV                  |
| 100 mV             | 95 kHz                     | 0.1% + 450 μV                   | 0.1% + 500 nV                        | 5 ppm/°C + 5 μV/°C   | 1 μV                                | 1 μV                   |
| 10 mV              | 95 kHz                     | 0.15% + 450 μV                  | 0.15% + 50 nV                        | 5 ppm/°C + 5 μV/°C   | 1 μV                                | 100 nV                 |

### Noise (typical)

| Range  | Voltage noise at 1 kHz | Voltage noise at 0.1 Hz to 10 Hz |
|--------|------------------------|----------------------------------|
| 10 V   | 100 nV/√Hz             | 1 μV RMS (5 μV p-p)              |
| 1 V    | 40 nV/√Hz              | 500 nV RMS (2.5 μV p-p)          |
| 100 mV | 40 nV/√Hz              | 350 nV RMS (1.75 μV p-p)         |
| 10 mV  | 40 nV/√Hz              | 350 nV RMS (1.75 μV p-p)         |

### Output impedance

| Range  | Absolute resistance |
|--------|---------------------|
| 10 V   | <0.1 Ω              |
| 1 V    | <0.1 Ω              |
| 100 mV | <0.1 Ω              |
| 10 mV  | <0.1 Ω              |

### Wideband noise (DC to 100 MHz): 2 mV RMS

<sup>1</sup> Both DC and AC range less than or equal to the range

<sup>2</sup> Total system accuracy, 1 year and ±5 °C from Lake Shore calibration, 24 h and ±1 °C from self-calibration, 95% confidence

<sup>3</sup> DC to 1 kHz

<sup>4</sup> Averaging over 60 NPLCs

# Top material research applications and the M81 modules used

## DC transport

### I-V curves, 4-wire

(VS module + CM module, primarily)

**Ideal for:** 2D materials, nanowires, organic semiconductors

**M81-SSM advantages:** Low-voltage source noise, low-current measure noise

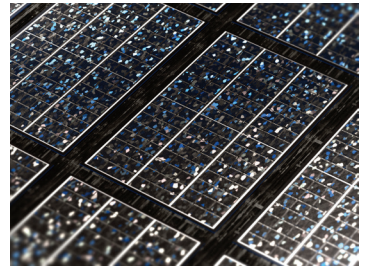

## AC transport

### AC resistance, sheet resistance, and AC current Hall

(BCS module + VM module)

**Ideal for:** Metal-insulator transitions, 2D materials, superconducting materials

**M81-SSM advantages:** AC current Hall: synchronous measurement of resistance and Hall voltages; and simultaneous measurement of up to three devices in a cryostat at different frequencies

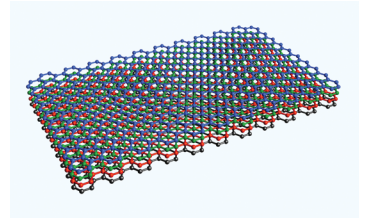

### Photodiodes and phototransistors

(CM module + occasionally VS module)

**Ideal for:** IR sensitive materials, solar-blind materials, 2D materials

**M81-SSM advantages:** Programmable offset voltage source

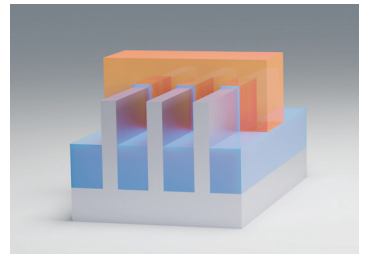

## Spin transport

(DC/AC: BCS module + VM module)

**Ideal for:** Spin orbit torque (SOT), non-local resistance, spin valves

**M81-SSM advantages:** SOT: synchronous measurement of resistance, Hall voltages, and harmonic Hall voltages

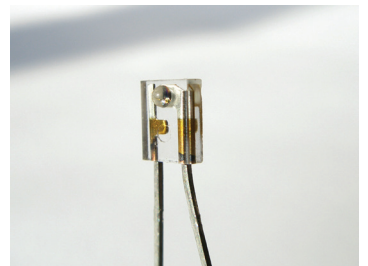

## Differential conductance

(VS module + CM module)

**Ideal for:** MIS junctions, Josephson junctions, defect characterization in transistors

**M81-SSM advantages:** Junctions: dual DAC AC and DC sourcing (source at appropriate range)



## Thermal transport

(AC, BCS module + VM module)

**Ideal for:** Thermoelectric materials, 1D materials

**M81-SSM advantages:** Phase-correlated current sources, synchronous harmonic detection

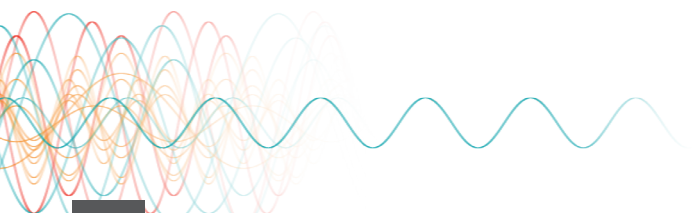
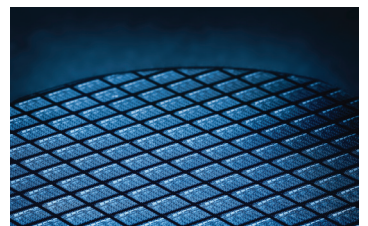



# Application focus — M81 and Hall bar measurements

Magnetotransport and harmonic Hall effect measurements are primary characterization methodologies for a wide variety of materials — high mobility 2DEGs, graphene, magnetic semiconductors, and spin-orbit torque heterostructures. For low resistance materials in particular, samples are often etched or milled into a Hall bar geometry and a current source drives a uniform current through the long axis of the bar. The voltage drop along the current channel,  $V_R$ , is measured using narrow legs or taps along the current direction. Deflection of the current due to applied and internal magnetic fields manifests as a Hall voltage,  $V_H$ , detected in the legs perpendicular to the current flow. In certain applications, the measured voltages are exceedingly small and need to be extracted using lock-in techniques. The M81-SSM offers key advantages in these scenarios for both sourcing and detection.

## AC current source

Conventionally, single-ended current sources are employed in Hall bar measurements. These single-ended sources drive current into the positive terminal of the Hall bar, which is returned to ground. In the single-ended configuration, there is a different impedance on each end of the Hall bar load and common mode voltage fluctuations, such as line pickup, are more easily coupled into the measurement circuit. With these common mode fluctuations, longer lock-in averaging times may be necessary in order to achieve an acceptable signal to noise ratio. Minimizing common mode fluctuations in Hall bar applications, the M81-SSM is configured with a balanced current source (BCS) for AC current excitation of the device. Configured as a differential source, the BCS module sources and sinks the prescribed current with two coordinated voltage-controlled source circuits. A common mode rejection connection on the source module is attached to a Hall bar's shared leg and provides active feedback to reduce common mode voltage on the load.

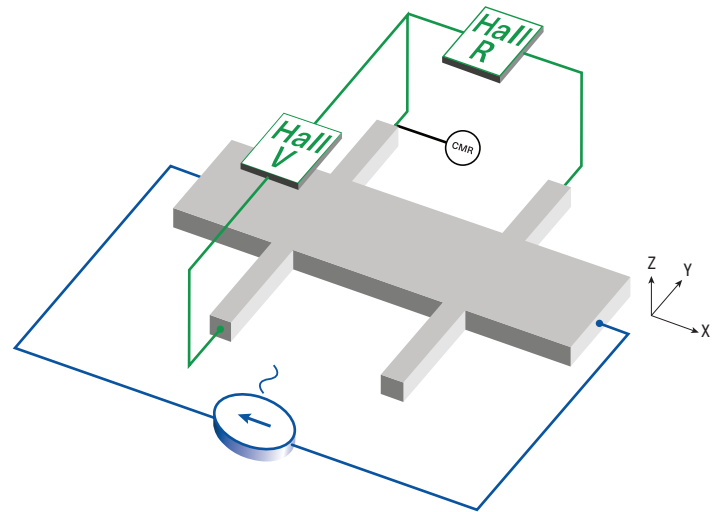

## Voltage detection

In AC current Hall bar measurements, two lock-in amplifiers are typically used in order to simultaneously measure  $V_R$  and  $V_H$  as a function of magnetic field or temperature. Due to cost considerations, a single lock-in could be switched between the two voltage measurement configurations; however, waiting for the lock-in to resettle after a configuration change is time-consuming. As the two measurements are acquired at different times, system drift can skew measurement results. For typical Hall bar measurements, the M81-SSM can be configured with two voltage measure (VM) modules — one for  $V_H$  and one for  $V_R$ . For harmonic Hall measurements, the second harmonic of the oscillating Hall voltage characterizes the strength and nature of the spin-orbit interaction. In this case, a third VM module, configured to measure the second harmonic, is added in parallel to the  $V_H$  legs. Whether configured with two or three VM modules, the M81-SSM platform can be queried to return synchronous lock-in results from all connected measurement modules.

# Positioning and mounting accessories

## Included mounting plates



Included with each module: a top clip for module-to-module stacking and a bottom clip for surface mounting (shown attached underneath).

## Optional module rack mount kit (M81-RMP-3)



## Optional module rack mount panel (M81-RMK-2)

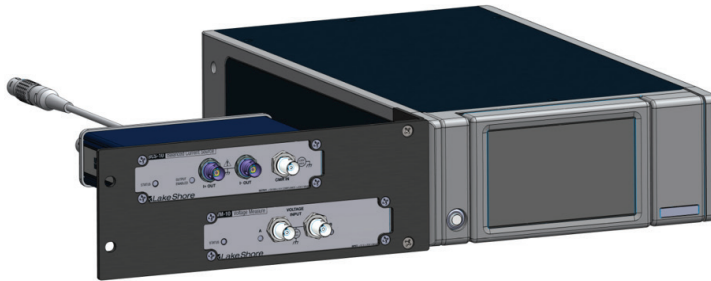

## Two optional module rack mount kits (M81-RMP-3) paired with an optional rack mount kit for two MeasureReady instruments (RM-2)

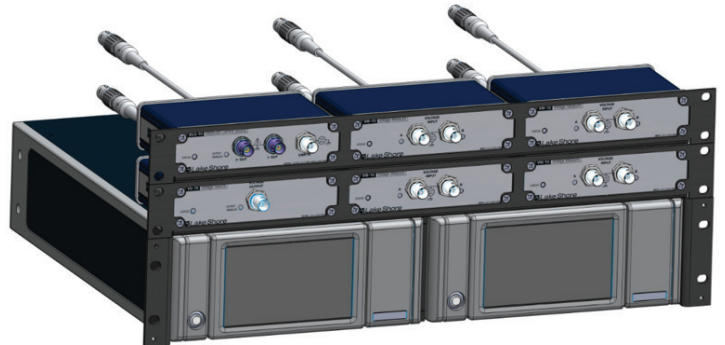

## Optional probe station mounting kit (M81-PMK-1)

Includes shelf for mounting M81-SSM modules on Lake Shore probe stations adjacent to a DUT.

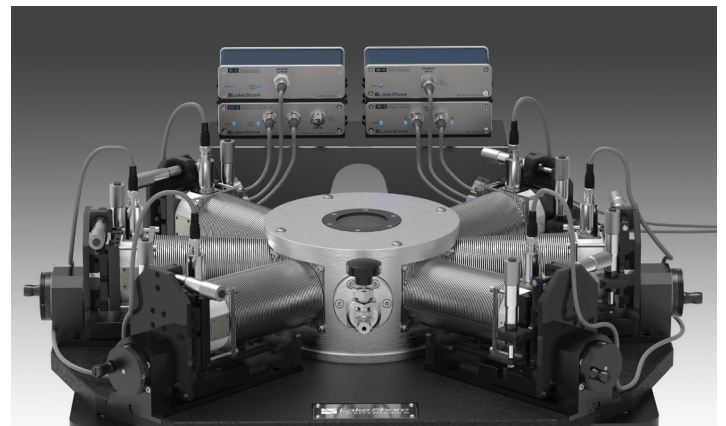

# Ordering information

## M81 instruments

|                  |   |
|------------------|---|
| <b>M81-SSM-2</b> | M81 synchronous source measure system instrument with 1 source and 1 measure channel  |
| <b>M81-SSM-4</b> | M81 synchronous source measure system instrument with 2 source and 2 measure channels |
| <b>M81-SSM-6</b> | M81 synchronous source measure system instrument with 3 source and 3 measure channels |

## M81-SSM source and measure modules

|                   |  |
|-------------------|--|
| <b>M81-SMU-10</b> | 10 V/100 mA source measure module          |
| <b>M81-BCS-10</b> | 100 mA/10 V balanced current source module |
| <b>M81-VS-10</b>  | 10 V/100 mA voltage source module          |
| <b>M81-VM-10</b>  | 10 V voltage measure module                |
| <b>M81-CM-10</b>  | 100 mA/10 V current measure module         |

## MeasureLINK

|                      |  |
|----------------------|--|
| <b>ML-MCS</b>        | MeasureLINK-MCS software with scripting development license              |
| <b>ML-AP-MULTIVU</b> | MeasureLINK-MCS application pack; Quantum Design MultiVu software access |

## Accessories

|                         |  |
|-------------------------|--|
| <b>112-812</b>          | Instrument LEMO to BNC adapter cable, 2 m (6.6 ft)   |
| <b>112-815</b>          | Instrument LEMO to module extension cable, 4 m (13 ft)   |
| <b>112-819</b>          | PPMS to Lake Shore M81-BNC-DB25 cable, 2 m (6 ft)  |
| <b>601-804</b>          | 0.91 m (36 in) BNC cable   |
| <b>601-804B</b>         | 0.46 m (18 in) BNC cable   |
| <b>654-275</b>          | Triaxial to BNC adapter (2 included with each M81-BCS-10)  |
| <b>843-076</b>          | Low noise triaxial cable, 3-slot, 1 m (3 ft)   |
| <b>P12379</b>           | BNC female to triaxial adapter, TRB male, isolated, 50 $\Omega$ , 3-lug                                |
| <b>117-017</b>          | 1 m (3.3 ft) long IEEE-488 (GPIB) computer interface cable assembly                                    |
| <b>RM-2</b>             | Rack mount kit—two adjacent half-rack instruments  |
| <b>RM-1/2</b>           | Rack mount kit—single half-rack instrument   |
| <b>M81-RMK-2</b>        | Rack mount kit for M81 instrument and 2 modules (2U)   |
| <b>M81-RMP-3</b>        | Rack mount kit for 3 M81-SSM modules (1U)  |
| <b>M81-PMK-1</b>        | Mounting kit for mounting M81-SSM modules on a Lake Shore probe station                                |
| <b>M81-MODULE-CLIPS</b> | Mating pair of 2 stacking/mounting clips for M81-SSM modules including rubber feet and mounting screws |
| <b>M81-TEST-KIT</b>     | Demo test box kit with 5 plug-in sample cards, cables  |
| <b>M81-BNC-DB25</b>     | Breakout box adapter for QD DynaCool/OptiCool systems with M81-SSM                                     |

 Measure Ready

# M81 SSM

### Questions? Answers?

Visit <http://forums.lakeshore.com/>  
and become part of the conversation!



The screenshot shows the Lake Shore Cryotronics User Group Forum website. At the top is the Lake Shore Cryotronics logo. Below it is the title "User Group Forum". A navigation bar includes "Home" and a search box with a "Search" button. A breadcrumb trail reads "Lake Shore > Material Characterization Products > Meas". Below this is a prompt: "Talk to fellow users and Lake Shore experts". A section titled "Sub-Boards" contains a table with one entry:

|  | Board  |
|--|--|
|  | <b>I/V source discussion</b><br>Discuss Lake Shore I/V source applications, review |

Copyright © Lake Shore Cryotronics, Inc. All rights reserved. Specifications are subject to change.

Lake Shore Cryotronics, the Lake Shore logo, the square graph logomark, and Cemox are registered trademarks of Lake Shore Cryotronics, Inc.

All other trade names referenced are the service marks, trademarks, or registered trademarks of their respective companies.

041425

