



---

# User's Manual

## Model MTD-120/121

### Modular Test Dewar

### Cryotest System

#### Obsolete Notice:

This manual describes an obsolete Lake Shore product. This manual is a copy from our archives and may not exactly match your instrument. Lake Shore assumes no responsibility for this manual matching your exact hardware revision or operational procedures. Lake Shore is not responsible for any repairs made to the instrument based on information from this manual.



Lake Shore Cryotronics, Inc.  
575 McCorkle Blvd.  
Westerville, Ohio 43082-8888 USA

Internet Addresses:  
[sales@lakeshore.com](mailto:sales@lakeshore.com)  
[service@lakeshore.com](mailto:service@lakeshore.com)

Visit Our Website:  
[www.lakeshore.com](http://www.lakeshore.com)

Fax: (614) 891-1392  
Telephone: (614) 891-2243

Methods and apparatus disclosed and described herein have been developed solely on company funds of Lake Shore Cryotronics, Inc. No government or other contractual support or relationship whatsoever has existed which in any way affects or mitigates proprietary rights of Lake Shore Cryotronics, Inc. in these developments. Methods and apparatus disclosed herein may be subject to U.S. Patents existing or applied for. Lake Shore Cryotronics, Inc. reserves the right to add, improve, modify, or withdraw functions, design modifications, or products at any time without notice. Lake Shore shall not be liable for errors contained herein or for incidental or consequential damages in connection with furnishing, performance, or use of this material.

### LIMITED WARRANTY

Lake Shore Cryotronics, Inc. (henceforth Lake Shore), the manufacturer, warrants this product to be free from defects in material and workmanship for a period of twelve (12) months from the date of shipment. During the warranty period, under authorized return of instruments or component parts to Lake Shore freight prepaid, the company will repair, or at its option replace, any part found to be defective in material or workmanship, without charge to the Owner for parts, service labor or associated customary shipping cost. Replacement or repaired parts will be warranted for only the unexpired portion of the original warranty.

All products are thoroughly tested and calibrated to published specifications prior to shipment. Calibration Certifications are offered for six month periods only. Where such documentation must be updated, a re-certification service is offered by Lake Shore at a reasonable cost.

### LIMITATION OF WARRANTY

This warranty is limited to Lake Shore products purchased and installed in the United States, or Internationally through our approved distribution agents. This same protection will extend to any subsequent owner during the warranty period. It does not apply to damage caused by accident, misuse, fire, flood, or acts of God, from failure to properly install, operate, or maintain the product in accordance with the printed instructions provided. This warranty does not apply to defects resulting from improper or inadequate maintenance, unauthorized modification or misuse, operation outside of the environmental specifications for any product or part or buyer-supplied software interfacing.

This warranty is in lieu of any other warranties, expressed or implied, including merchantability or fitness for a particular purpose, which are expressly excluded. The owner agrees that Lake Shore's liability with respect to this product shall be set forth in this warranty, and incidental or consequential damages are expressly excluded.

### CERTIFICATION

Lake Shore certifies that this product has been inspected and tested in accordance with its published specifications and that this product met its published specifications at the time of shipment. The accuracy and calibration of this product at the time of shipment are traceable to the United States National Institute of Standards and Technology (NIST); formerly known as the National Bureau of Standards (NBS).

### TRADEMARK ACKNOWLEDGMENT

Many of the designations used by manufacturers and sellers to distinguish their products are claimed as trademarks. Where those designations appear in this manual and Lake Shore was aware of a trademark claim, the designations have been printed in initial capital letters and the <sup>TM</sup> or <sup>®</sup> symbol used.

Apiezon<sup>®</sup> is a trademark of Biddle Instruments

Cryo-Gloves<sup>®</sup> is a trademark of TeMTD-120hield

Swagelok<sup>®</sup> is a trademark of the Swagelok Company

Teflon<sup>®</sup> is a trademark of DuPont De Nemours

CryoCable<sup>™</sup>, Duo-Twist<sup>™</sup>, SoftCal<sup>™</sup>, Quad-Lead<sup>™</sup>, and Quad-Twist<sup>™</sup> are trademarks of Lake Shore Cryotronics, Inc.

Copyright © 1994, 1995, and 1997 by Lake Shore Cryotronics, Inc. All rights reserved. No portion of this manual may be reproduced, stored in a retrieval system, or transmitted, in any form or by any means, electronic, mechanical, photocopying, recording, or otherwise, without the express written permission of Lake Shore.

## TABLE OF CONTENTS

<i>Chapter/Paragraph</i>	<i>Title</i>	<i>Page</i>
	List of Illustrations .....	ii
	List of Tables .....	ii
	Foreword .....	iii
	Purpose and Scope .....	iii
	Hardware Covered .....	iii
	Lake Shore Sensors .....	iii
	How To Use This Manual .....	iii
	Warning, Cautions, and Notes .....	iii
	General Installation Precautions .....	iii
	Electrostatic Discharge .....	iv
	Handling Electrostatic Discharge Sensitive Components .....	iv
	Handling Cryogenic Storage Dewars .....	v
	Liquid Helium and Nitrogen Safety Precautions .....	v
	Recommended First Aid .....	v
	Safety Summary .....	vi
	Safety Symbols .....	vi
<b>1</b>	<b>INTRODUCTION .....</b>	<b>1-1</b>
1.0	General .....	1-1
1.1	MTD-120 Cryotest System General Description .....	1-1
1.2	MTD-120 Cryotest System Features .....	1-3
1.3	Hardware Descriptions and Functions .....	1-6
<b>2</b>	<b>INSTALLATION .....</b>	<b>2-1</b>
2.0	General .....	2-1
2.1	Inspection and Unpacking .....	2-1
2.2	Repackaging For Shipment .....	2-1
2.3	Environmental Requirements .....	2-1
2.4	System Power and Ground Requirements .....	2-2
2.5	Physical Support Requirements .....	2-2
2.6	Liquid Cryogen .....	2-2
2.7	Instrumentation Hookup Instructions .....	2-3
2.8	Miscellaneous Precautions .....	2-3
2.9	Device Under Test (DUT) Insertion .....	2-4
<b>3</b>	<b>OPERATION .....</b>	<b>3-1</b>
3.0	General .....	3-1
3.1	MTD System Operation .....	3-1
3.2	MTD System Shutdown .....	3-2
<b>4</b>	<b>TROUBLESHOOTING .....</b>	<b>4-1</b>
4.0	General .....	4-1
4.1	Water Condenses On Outer Surface Of Vacuum Chamber .....	4-1
4.2	Unable To Reach Cold Terminal Temperature .....	4-1
4.3	No Response To Control Heater .....	4-1
4.4	Cable Assembly .....	4-1
<b>5</b>	<b>OPTIONS, ACCESSORIES AND CABLES .....</b>	<b>5-1</b>
5.0	General .....	5-1
5.1	MTD Cryotest System Options .....	5-1
5.2	Accessories .....	5-1
	<b>APPENDIX A – UNITS FOR MAGNETIC PROPERTIES .....</b>	<b>A-1</b>

## LIST OF ILLUSTRATIONS

<i>Figure No.</i>	<i>Title</i>	<i>Page</i>
F-1	Typical Cryogenic Storage Dewar .....	v
1-1	Typical MTD-120 and MTD-121 Cryotest System .....	1-1
1-2	Typical MTD-120 Cutaway .....	1-4
1-3	Typical MTD-121 Cutaway .....	1-5
1-4	Typical Fanout Board Wiring .....	1-6
1-5	10-Pin Instrumentation Feedthrough Connector .....	1-7
1-6	50-Pin Signal Feedthrough Connector .....	1-8
1-7	Vacuum Valve Cutaway .....	1-9
2-1	MTD-120 Hookup to the Model 330 Temperature Controller .....	2-3
3-1	Typical MTD-120 Cryotest System Operational Setup .....	3-1
4-1	Definition of Model 8271-30M-10 Cable Assembly .....	4-2

## LIST OF TABLES

<i>Table No.</i>	<i>Title</i>	<i>Page</i>
1-1	Model MTD-120 Cryotest System Specifications .....	1-2

# FOREWORD

## PURPOSE AND SCOPE

This manual contains user instructions for the Modular Test Dewar Model MTD-120 Crytest System. Lake Shore Cryotronics, Inc. designed, manufactures, and assembles the MTD-120 in the United States of America.

We welcome your comments concerning this manual. Although every effort has been made to keep it free of errors, some may occur. To report a specific problem, please describe it briefly and include the manual part number, the paragraph/figure/table number, and the page number. Send comments to Lake Shore Cryotronics, Inc. Attn: Technical Publications, 575 McCorkle Blvd., Westerville, Ohio 43082-8888.

## HARDWARE COVERED

Modular Test Dewar Model MTD-120/121 Cryotest System.

## LAKE SHORE SENSORS

The MTD-120 Cryotest System uses the Lake Shore Series DT-470 Silicon Diode Temperature Sensor. Sensor installation is covered in detail in the Lake Shore Product Catalog, Application Notes, and Technical Data. Contact Lake Shore for further information.

## HOW TO USE THIS MANUAL

This manual includes a Table of Contents in the front. It prefaces figure and table numbers with an F or T respectively, and Appendix information with the Appendix Letter (A-1.0). It delineates a figure or table reference within an appendix by a slash (/), e.g., T/A-1.

## WARNINGS, CAUTIONS, AND NOTES

Warnings, cautions, and notes appear throughout this manual and always precede the step to which they pertain. Multiple warnings, cautions, or notes are bulleted.

**WARNING:** An operation or maintenance procedure which, if not strictly observed, may result in injury, death, or long-term health hazards to personnel.

**CAUTION:** An operation or maintenance procedure which, if not strictly observed, may result in equipment damage, destruction, or loss of effectiveness.

**NOTE:** Emphasizes an operation or maintenance procedure.

## GENERAL INSTALLATION PRECAUTIONS

These recommended general safety precautions are unrelated to any specific procedure and do not appear elsewhere in this manual. Personnel should understand and apply these precautions during installation.

Installation personnel shall observe all safety regulations at all times. Keep away from live circuits. Turn off system power before making or breaking electrical connections. Regard any exposed connector, terminal board, or circuit board as a possible shock hazard. Discharge charged components only when such grounding cannot damage equipment. If a test connection to energized equipment is required, make the test equipment ground connection before probing the voltage or signal.

Do not install or service equipment alone. Do not under any circumstances reach into or enter any enclosure to service or adjust equipment without the presence or assistance of another person able to render aid.

## ELECTROSTATIC DISCHARGE

Electrostatic Discharge (ESD) may damage electronic parts, assemblies, and equipment. ESD is a transfer of electrostatic charge between bodies at different electrostatic potentials caused by direct contact or induced by an electrostatic field. The low-energy source that most commonly destroys Electrostatic Discharge Sensitive (ESDS) devices is the human body, which generates and retains static electricity. Simply walking across a carpet in low humidity may generate up to 35,000 volts of static electricity.

Current technology trends toward greater complexity, increased packaging density, and thinner dielectrics between active elements, which results in electronic devices with even more ESD sensitivity. Some electronic parts are more ESDS than others. ESD levels of only a few hundred volts may damage electronic components such as semiconductors, thick and thin film resistors, and piezoelectric crystals during testing, handling, repair, or assembly. Discharge voltages below 4000 volts cannot be seen, felt, or heard.

### Identification of Electrostatic Discharge Sensitive Components

Below are various industry symbols used to label components as ESDS:



### HANDLING ELECTROSTATIC DISCHARGE SENSITIVE COMPONENTS

Observe all precautions necessary to prevent damage to ESDS components before attempting installation. Bring the device and everything that contacts it to ground potential by providing a conductive surface and discharge paths. As a minimum, observe these precautions:

1. De-energize or disconnect all power and signal sources and loads used with unit.
2. Place unit on a grounded conductive work surface.
3. Ground technician through a conductive wrist strap (or other device) using 1 M $\Omega$  series resistor to protect operator.
4. Ground any tools, such as soldering equipment, that will contact unit. Contact with operator's hands provides a sufficient ground for tools that are otherwise electrically isolated.
5. Place ESDS devices and assemblies removed from a unit on a conductive work surface or in a conductive container. An operator inserting or removing a device or assembly from a container must maintain contact with a conductive portion of the container. Use only plastic bags approved for storage of ESD material.
6. Do not handle ESDS devices unnecessarily or remove them from their packages until actually used or tested.

## HANDLING CRYOGENIC STORAGE DEWARS

Operate all cryogenic containers (dewars) in accordance with manufacturer instructions. Safety instructions are normally posted on the side of each dewar. Keep cryogenic dewars in a well-ventilated place, protected from the weather, and away from heat sources. Figure F-1 shows a typical cryogenic dewar.

## LIQUID HELIUM AND NITROGEN SAFETY PRECAUTIONS

Transfer LHe and LN<sub>2</sub> and operate storage dewar controls in accordance with manufacturer/supplier instructions. During transfer, follow all safety precautions written on the storage dewar and recommended by the manufacturer.

### WARNING

- **Liquid helium is a potential asphyxiant and can cause rapid suffocation without warning. Store and use in an adequately ventilated area. DO NOT vent the container in confined spaces. DO NOT enter confined spaces where gas may be present unless area is well-ventilated. If inhaled, remove to fresh air. If not breathing, give artificial respiration. If breathing is difficult, give oxygen. Get medical attention.**
- **Liquid helium can cause severe frostbite to exposed body parts. DO NOT touch frosted pipes or valves. For frostbite, consult a physician immediately. If a physician is unavailable, warm the affected parts with water that is near body temperature.**

Two essential safety aspects of handling LHe are adequate ventilation and eye and skin protection. Although helium and nitrogen gases are non-toxic, they are dangerous because they replace air in a normal breathing atmosphere. Liquid helium is an even greater threat because a small amount of liquid evaporates to create a large amount of gas. Store and operate cryogenic dewars in open, well-ventilated areas.

When transferring LHe and LN<sub>2</sub>, protect eyes and skin from accidental contact with liquid or the cold gas issuing from it. Protect eyes with full face shield or chemical splash goggles; safety glasses (even with side shields) are inadequate. Always wear special cryogenic gloves (TeMTD-120hield Cryo-Gloves® or equivalent) when handling anything that is, or may have been, in contact with the liquid or cold gas, or with cold pipes or equipment. Wear long sleeve shirts and cuffless trousers long enough to prevent liquid from entering shoes.

## RECOMMENDED FIRST AID

Post an appropriate Material Safety Data Sheet (MSDS) obtained from the manufacturer/distributor at every site that stores and uses LHe and LN<sub>2</sub>. The MSDS specifies symptoms of overexposure and first aid.

If a person exhibits symptoms of asphyxia such as headache, drowsiness, dizziness, excitation, excessive salivation, vomiting, or unconsciousness, remove to fresh air. If breathing is difficult, give oxygen. If breathing stops, give artificial respiration. Call a physician immediately.

If exposure to cryogenic liquids or cold gases occurs, restore tissue to normal body temperature (98.6°F) by bathing it in warm water not exceeding 105 °F (40 °C). DO NOT rub the frozen part, either before or after rewarming. Protect the injured tissue from further damage and infection and call a physician immediately. Flush exposed eyes thoroughly with warm water for at least 15 minutes. In case of massive exposure, remove clothing while showering with warm water. The patient should not drink alcohol or smoke. Keep warm and rest. Call a physician immediately.

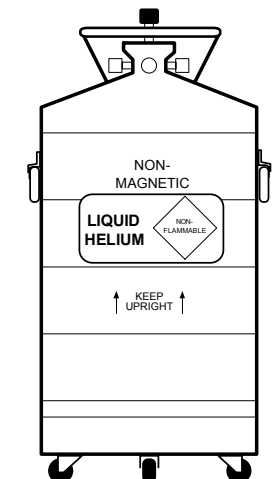

Figure F-1 Cryogenic Storage Dewar

## SAFETY SUMMARY

Observe the following general safety precautions during all phases of operation, service, and repair of this instrument. Failure to comply with these precautions or with specific warnings elsewhere in this manual violates safety standards of design, manufacture, and intended use of the instrument. Lake Shore Cryotronics, Inc. assumes no liability for the customer's failure to comply with these requirements.

### Ground the Instrument

To minimize shock hazard, connect the instrument chassis and cabinet to an electrical ground. The instrument is equipped with a three-conductor AC power cable. Plug this cable into either an approved three-contact electrical outlet or a three-contact adapter with the grounding wire (green) firmly connected to an electrical ground (safety ground) at the power outlet. The power jack and mating plug of the power cable meet Underwriters Laboratories (UL) and International Electrotechnical Commission (IEC) safety standards.

### Do Not Operate in an Explosive Atmosphere

Do not operate the instrument in the presence of flammable gases or fumes. Operating any electrical instrument in such an environment constitutes a definite safety hazard.

### Keep Away from Live Circuits

Operating personnel must not remove instrument covers. Refer component replacement and internal adjustments to qualified maintenance personnel. Do not replace components with power cable connected. To avoid injuries, always disconnect power and discharge circuits before touching them.













### Do Not Substitute Parts or Modify Instrument

Do not install substitute parts or perform any unauthorized modification to the instrument. Return the instrument to an authorized Lake Shore Cryotronics, Inc. representative for service and repair to ensure that safety features are maintained.

### Dangerous Procedure Warnings

A WARNING heading precedes potentially dangerous procedures throughout this manual. Instructions in the warnings *must* be followed.

## SAFETY SYMBOLS

	Direct current (power line).		Equipment protected throughout by double insulation or reinforced insulation (equivalent to Class II of IEC 536 - see Annex H).
	Alternating current (power line).		Caution: High voltages; danger of electric shock. Background color: Yellow; Symbol and outline: Black.
	Alternating or direct current (power line).		Caution or Warning - See instrument documentation. Background color: Yellow; Symbol and outline: Black.
	Three-phase alternating current (power line).		Fuse.
	Earth (ground) terminal.		
	Protective conductor terminal.		
	Frame or chassis terminal.		
	On (supply).		
	Off (supply).		



# CHAPTER 1

## INTRODUCTION

### 1.0 GENERAL

The MTD-120 Cryotest System provides quality, economically high throughput testing of focal plane arrays and integrated circuits at stable cryogenic test temperatures. The modular design of the MTD systems reduces the time required for test device installation, cycle testing, and test device removal. The MTD systems provide high signal quality as well as quick and easy access to the device test area. See Chapter 6 for options and accessories.

### 1.1 MTD-120 CRYOTEST SYSTEM GENERAL DESCRIPTION

The MTD-120 System is a cost effective, single test position, hard-wired cryogenic test dewar system configured for rapid production testing of 40-pin dual in-line package (DIP) or 68- or 100-pin leadless chip carrier (LCC) devices at liquid nitrogen temperature ( $T \leq 80$  K). The standard system configuration includes an optical window port over the interior device under test (DUT) location. The MTD-120 features a high efficiency, pour-fill, single-stage cryostat which operates with liquid nitrogen cryogen. The MTD-120 operates vertically, while the MTD-121 operates horizontally. The factory can configure the system to test devices with packages other than the standard 40-pin DIP or 68- or 100-pin LCC package. Consult the factory for details.

The Model MTD-120 is a flexible tool which provides high signal quality, precise temperature control, and rapid test cycling. The unique design of the MTD optimizes test integrity by greatly minimizing the potential for vacuum leaks and signal interference while providing fast, easy access to the test chamber.

Functionally, the Model MTD-120 and MTD-121 are identical. However, the MTD-120 has a down-looking optical window and fills vertically through a fill port on the bottom. The MTD-121 has a side-looking optical window and fills horizontally through a fill port on the side of the vacuum shroud, with tripod mounting provisions on the side opposite the fill port. See Figure 1-1. In this manual, unless it is necessary to be specific, references to the MTD-120 include both models.

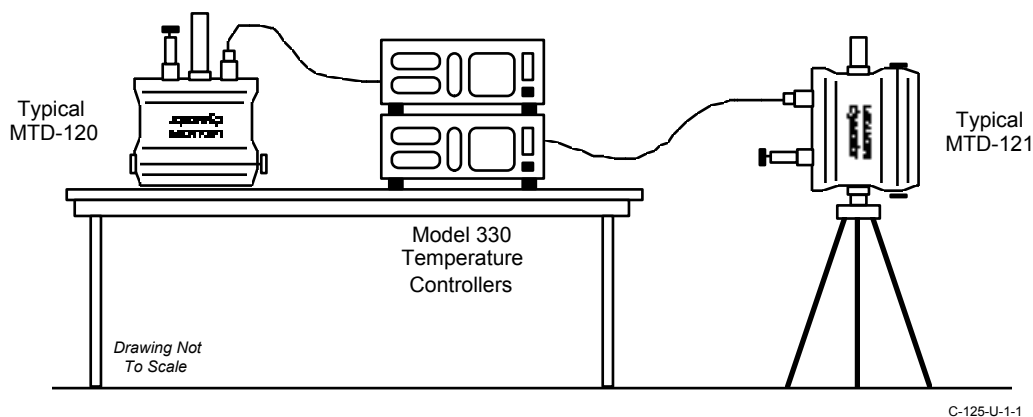

**Figure 1-1** Typical MTD-120 and MTD-121 Cryotest System

Table 1-1 Model MTD-120 Cryotest System Specifications

**Cryotest Mainframe:** Integrated single-stage, pour fill cryostat incorporating a high efficiency cold plate to provide rapid cooling of the sample mounting structure. The radiation shield encloses the DUT area. The cryostat is designed to use liquid nitrogen (LN<sub>2</sub>) cryogen. Approximately 0.75 liter capacity for LN<sub>2</sub>.

**Hold Time:** Greater than 8 hours with LN<sub>2</sub>, depending on device heat load.

**Temperature Range:** ≤ 80 K with liquid nitrogen.

**Cool Down Time:** About 15 minutes to 80 K.

**Warmup Time:** Approximately 20 minutes after removing cryogen from cryogenic test temperature to 300 K using a temperature controller with 50 watts of heater output power. The Lake Shore Model 330-11-W50 Autotuning Temperature Controller is recommended.

**Stability:** ±0.1 K at the cryogenic test temperatures.

**Accuracy:** ±0.5 K from 77 K to 100 K; ±1.0% from 100 K to 350 K

**Optical Configuration:** The vacuum chamber cover includes an optical window port positioned over the interior DUT location. This port accommodates a 5.1 cm (2 inches) diameter x 6 mm thick window. The nominal focal plane distance to the outside of the window is 3.8 cm (1.5 inches). A 2.54 cm (1 inch) diameter filter can be installed on the radiation shield. The clamp assembly for the DUT accommodates a 2.54 cm (1 inch) diameter filter and aperture.

**Signal Quality:** All signal lines are high quality semi-rigid, stainless steel coaxial cabling with solid shielding, 50 Ω characteristic impedance and <15 pfd input capacitance per lead. The 50 Ω impedance is maintained throughout the MTD-120 up to the DUT socket. The signal lines are suitable for bandwidths up to 100 MHz. All interior electrical contacts are gold-plated to enhance contact and inhibit corrosion. Dewar equivalent input noise is approximately  $8 \times 10^{-15}$  aMTD-120/√Hz. Cross-talk is less than 0.1% at 1 MHz with the adjacent lead terminated.

**Vacuum Performance:** System is leak tested at the factory to 10<sup>-8</sup> cc/sec (standard gaseous helium). Minimum vacuum level requirement before cool down is 10-20 microns. Vacuum pump is user-supplied.

**Vacuum Pumpout Port:** Standard configuration is a Cryolab 1/2-inch valve, Model S-V8, with 5/8 inch port/removable valve operator. Other configurations are available.

**Vacuum Feedthroughs:**

- One each 10-pin instrumentation feedthrough for temperature sensor and heater connections.
- Four high density, 17-line/34-pin, 50 Ω impedance feedthroughs for up to 68 signal lines.
- All feedthroughs are located on the base plate of the vacuum chamber.

**Cartridge Heaters:** One 50 Ω cartridge heater is installed in the MTD-120. The heater is located on the cryostat cold plate for system warmup. All heater lines connect to the 6-pin instrumentation feedthrough.

**Size:** 18 cm (7 inches) diameter by 33 cm (13 inches) long

**Weight:** 6.8 kilograms (15 pounds)

## 1.2 MTD-120 CRYOTEST SYSTEM FEATURES

**Easy access to device test area.** The vacuum shroud cover mates to the vacuum shroud body by two spring-loaded, quick-release clamp MTD-120, with a captive o-ring seal. Beneath the vacuum shroud cover, the radiation shield attaches to the cold stage with captive screws. Remove this radiation shield for quick and simple access to the device test area.

**Convenient, efficient, and economical.** The small, easy to handle MTD-120 has a ring base, while the MTD-121 has a tripod mount. The down-looking MTD-120 operates vertically with the DUT facing down. The side-looking MTD-121 operates horizontally, with the DUT facing to the side. The small size of both models and the highly efficient cryostat ensure the system uses a minimum amount of cryogen for cooldown and device testing.

**Rapid temperature cycling capability.** All MTD systems are built for optimum thermal performance. The MTD-120 is the best choice for small size and high efficiency. It has a single-stage cryostat that cools to cryogenic test temperatures in as little as 15 minutes. For maximum device testing throughput, use a Lake Shore temperature controller with 50 watts of heater output power to rapidly warm the system to room temperature. The Lake Shore temperature controller uses temperature sensors and cartridge heaters installed in all MTD systems. The Lake Shore Model 330-11-W50 Autotuning Temperature Controller is recommended for use with the MTD-120 system.

**Superior vacuum characteristics.** Instead of penetrating the test chamber with individual feedthroughs, each a potential source for a vacuum leak, the up to 68 coaxial signal lines terminate into four, high-density, 17-line (34-pin) vacuum feedthrough connectors. (Mating connectors are user supplied.) This configuration reduces discrete penetrations into the vacuum chamber—enhancing test environment integrity.

**High signal quality.** All MTD systems feature high quality, fully shielded coaxial signal lines with a 50  $\Omega$  characteristic impedance and 15-20 picofarads of input capacitance (<15 pfd for the MTD-120 system). The 50  $\Omega$  impedance is maintained throughout the MTD system up to the DUT socket. All interior electrical contact connections are gold-plated to enhance the contact and to inhibit corrosion.

**Precise monitoring and control of temperature over a wide range.** For temperature measurement and control purposes, temperature sensors (Lake Shore DT-470 Series Silicon Diode Sensors) and cartridge heaters are installed in the MTD system. Lake Shore also offers a complete line of temperature controllers compatible with the MTD systems. The selected Lake Shore temperature controller provides precise temperature measurement and control over the full cryotesting temperature range. The Lake Shore Model 330-11-W50 Autotuning Temperature Controller is recommended for use with the MTD-120. The temperature controller and cable are purchased separately.

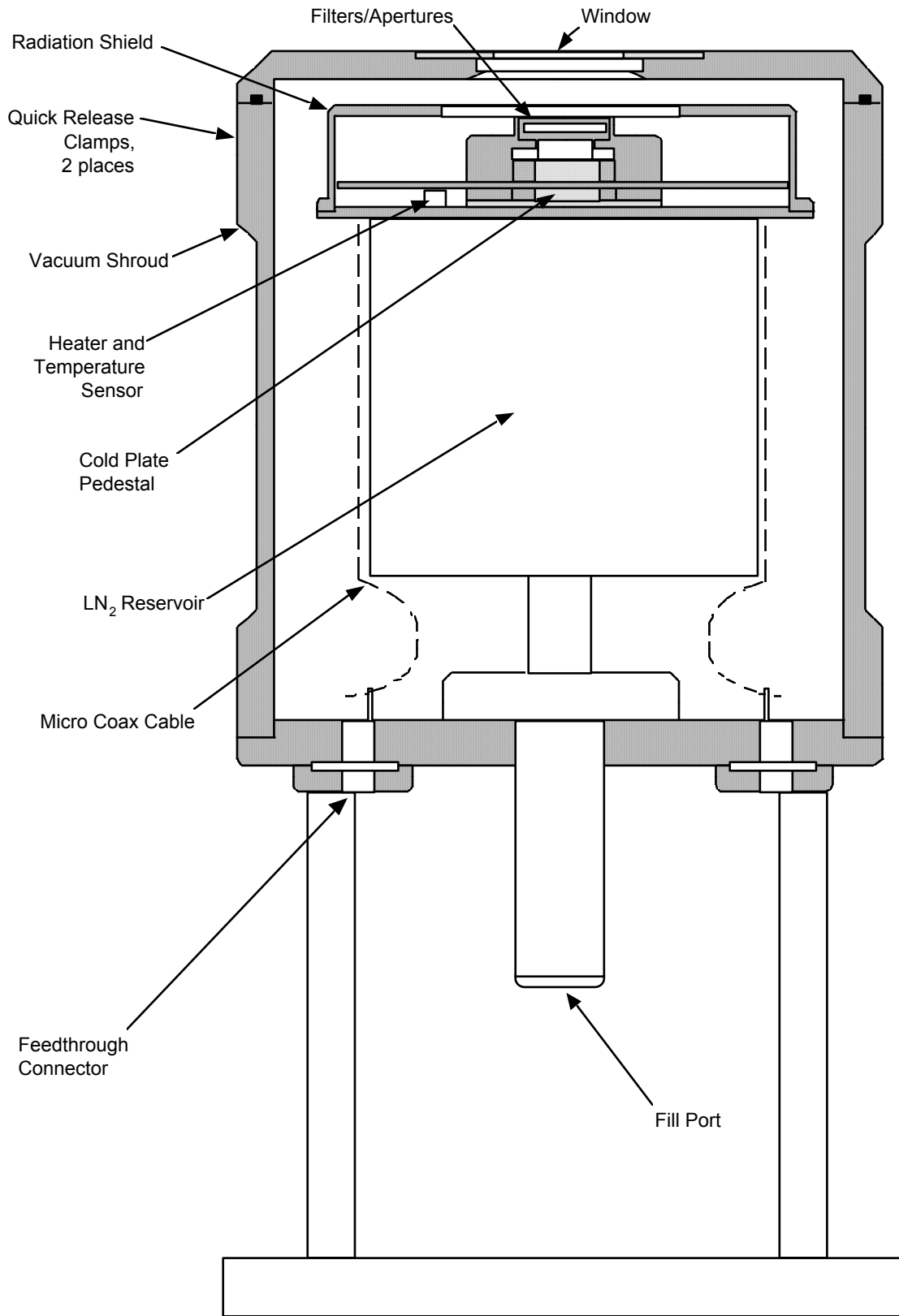

C-125-U-1-2

Figure 1-2 Typical MTD-120 Cutaway

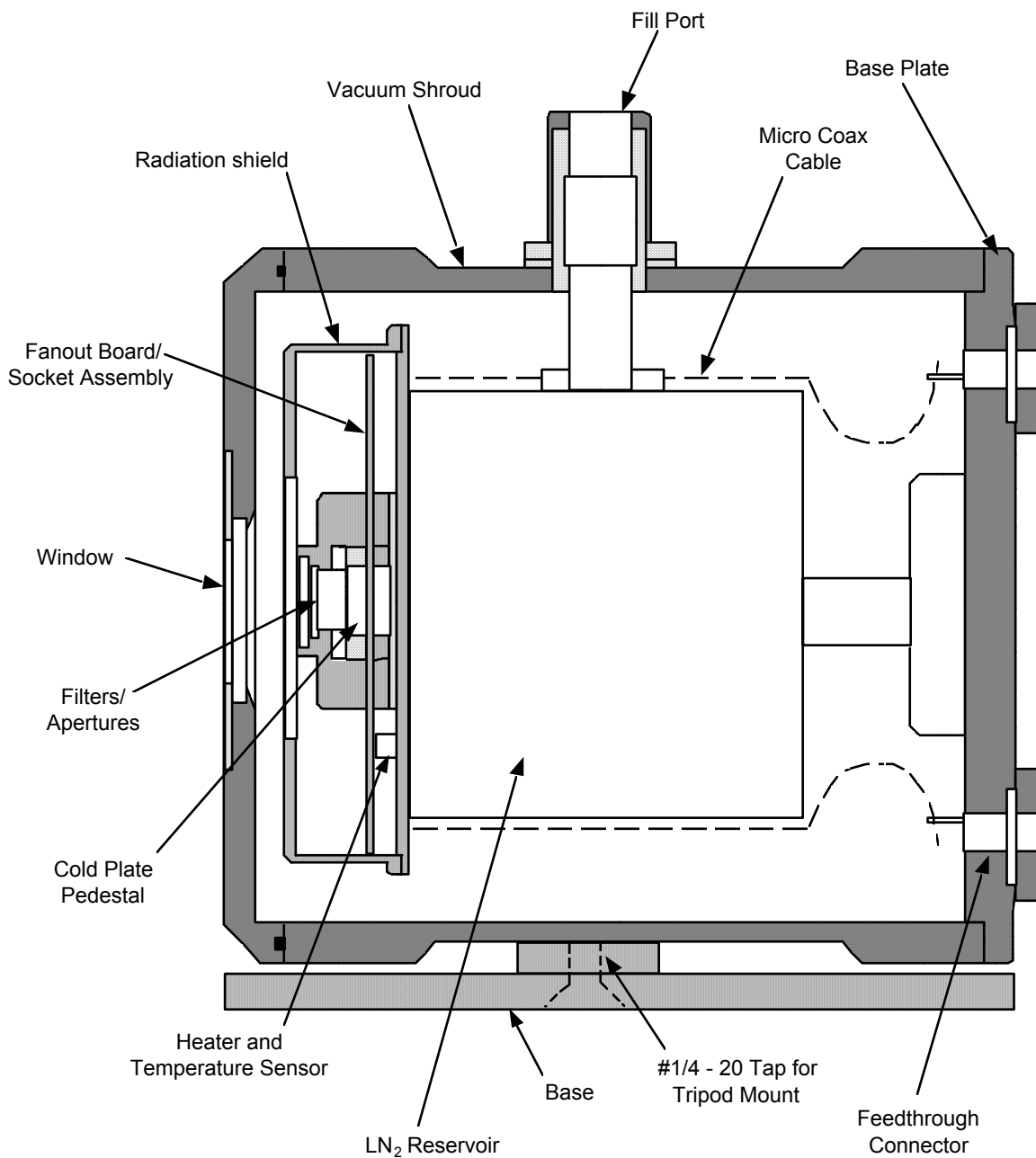

C-125-U-1-3

Figure 1-3 Typical MTD-121 Cutaway

**CAUTION**

- For the Model MTD-121 only, do not separate the base plate from the vacuum shroud. Damage to the unit may result since the fill port attaches to the reservoir which is attached to the baseplate.
- When venting or pumping out the system, release the vacuum slowly. A sudden vacuum release may damage the aluminized Mylar insulation.

### 1.3 HARDWARE DESCRIPTIONS AND FUNCTIONS

**CARTRIDGE HEATER:** One 50 Ω cartridge heater is installed in the MTD-120. The heater is located on the cryostat cold stage for system warmup. The heater lines connect to the 6-pin instrumentation feedthrough.

**CHIP CARRIER CLAMP ASSEMBLY:** Secures the chip carrier in the device socket and against the cold pedestal. It may also be used to hold the fixed aperture disks and optical filters. Its spring load ensures good thermal contact between the ceramic substrates on the device package and the cold pedestal.

**COLD PLATE AND PEDESTAL:** The cold plate provides a cooled mounting surface for the cold pedestal, fanout board, and chip carrier clamp assembly. The cold pedestal, which provides thermal interface between the DUT and the cold plate, mounts to the center of the cold plate and makes direct thermal contact with the DUT.

**CRYOSTAT:** Integrated single-stage, pour fill cryostat incorporating a high efficiency heat exchanger to provide rapid cooling of the sample mounting structure, the radiation shield which encloses the DUT area, and the heat sinks. The cryostat is designed for LN<sub>2</sub> cryogen.

**FANOUT BOARD TEST SET ASSEMBLY:** The standard system configuration includes the hard-wired installation of a 68-pin LCC device test set assembly. It includes a fanout board (with 50 ohm stripline transmission traces), a chip carrier socket mounted on the fanout board, a chip carrier clamp assembly, and a cold pedestal. The fanout board with the 68-pin LCC socket is permanently wired directly to the coax signal lines. A device clamp assembly positions the chip carrier against the cold pedestal. This clamp housing can hold 2.54 cm (1 inch) diameter apertures and/or filters.

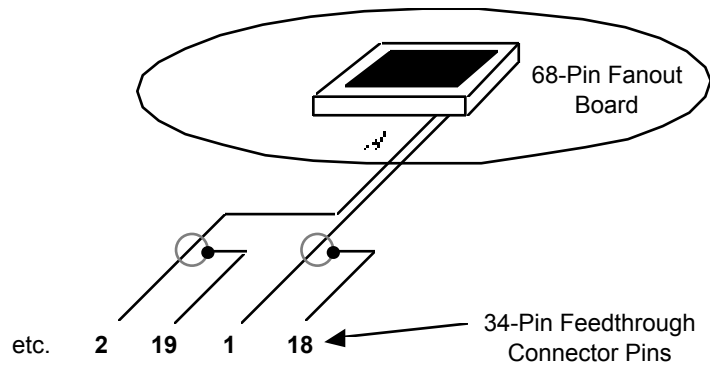

Figure 1-4 68-Pin Fanout Board Wiring

**NOTE:** Because the MTD-120 test configuration is hard-wired, it cannot be reconfigured in the field to test devices with packages other than 68-pin LCC. However, the MTD-120 can be built to test devices with other packages. Contact Lake Shore for details on custom configurations.

**INSTRUMENTATION FEEDTHROUGH CONNECTOR:** The 6-pin Instrumentation Feedthrough Connector is located on the main body of the cryostat. Temperature control and measurement electrical connections are made through the o-ring sealed electrical feedthrough. Only 4 of the 6 pins are used in a standard Model MTD-120 Installation. This allows for future installation of additional instrumentation leads. See Figure 1-5 for connector definition.

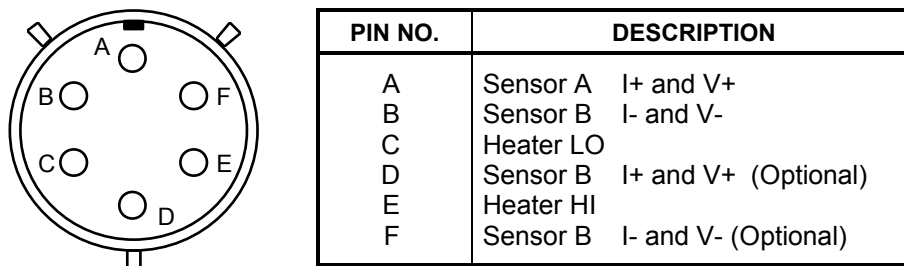

Figure 1-5 10-Pin Instrumentation Feedthrough Connector

**MICROCOAX CABLING SIGNAL LINES:** System configuration is 68 semi-rigid stainless steel microcoax cables with solid shielding which interconnect the hard-wired fanout board and the four 34-pin (17-line) vacuum feedthrough connectors. All 100 coax signal lines are thermally sunk to the cryostat cold plate to reduce heat conduction along signal lines to the DUT area. Coax cable shields electrically float up to their common ground plane interface connection. Ground plane terminations for the coax shields can be isolated upon request.

**RADIATION SHIELD:** A gold plated radiation shield controls the thermal and optical radiation environment around the device under test. The radiation shield completely encloses the DUT area and attaches to the cold plate with captive screws. With an optional adapter, a 1-inch (2.54 cm) diameter filter/aperture can be mounted on the radiation shield.

**SIGNAL FEEDTHROUGH CONNECTOR:** Four 34-pin connectors labeled A, B, C, and D pass through the 68 connections from the fanout board. As a default setup for a Model MTD-120, the inner row of 17 pins are the signal lines and the outer row is the shield for that corresponding line (as shown in Figure 1-4). See Figure 1-6 for signal feedthrough connector definition.

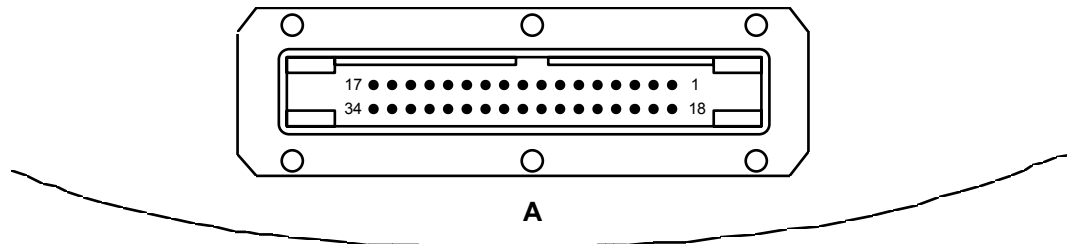

Figure 1-6 50-Pin Signal Feedthrough Connector

**TEMPERATURE SENSOR:** One Lake Shore Model DT-470-CU-12A Silicon Diode Cryogenic Temperature Sensor is installed on the MTD-120 cold plate. The sensor measures and controls the DUT temperature and is also utilized during system warmup. It wires to the 6-pin instrumentation feedthrough. For more precise monitoring of DUT temperature, a second sensor can be added to the cold pedestal.

**VACUUM CHAMBER:** Externally black anodized, machined aluminum cylinder which encloses the cryostat cold plate, the signal lines, and the device test area. The complete vacuum chamber consists of a vacuum shroud cover, body, and base plate.

**VACUUM CHAMBER BASE PLATE:** The vacuum shroud body and cryostat attach to the base plate. All electrical feedthroughs pass through the base plate located on the bottom of the vacuum chamber. The signal line and instrumentation vacuum feedthroughs also mount on the base plate.

**VACUUM SHROUD BODY:** Main section of the vacuum chamber, mounted to the base plate. Remove vacuum shroud body from the base plate for access to system wiring and mechanical components.

**VACUUM SHROUD COVER:** Remove the vacuum shroud cover to expose the radiation shield, which encloses the device testing area. The vacuum shroud cover mates to the vacuum shroud body by two (2) spring-loaded, quick release clamps; an o-ring is embedded in the shroud cover to assure a vacuum tight fit between the vacuum shroud cover and body. The cover includes a 5.1 cm (2 inches) diameter x 6 mm window blank over the DUT area.

**VACUUM FEEDTHROUGHS:** One each 6-pin instrumentation feedthrough for temperature sensor and heater connections. Four high density, 17-line/34-pin, 50  $\Omega$  impedance feedthroughs for the 68 signal lines. All feedthroughs are located on the base plate of the vacuum chamber.

#### CAUTION

- For the Model MTD-121 only, do not separate the base plate from the vacuum shroud. Damage to the unit may result since the fill port attaches to the reservoir which is attached to the baseplate.
- When venting or pumping out the system, release the vacuum slowly. A sudden vacuum release may damage the aluminized Mylar insulation.

**VACUUM PUMPOUT PORT:** Standard configuration is a Cryolab valve with 0.625 inch O.D. tube outlet. Consult factory for other termination options. The vacuum pumpout port connects a vacuum pump to evacuate/isolate vacuum chamber space. It also serves as a pressure relief in case of vacuum chamber overpressure. See Figure 1-7. In normal operation, the handle threads into the valve. The vacuum space may then be manually opened or closed.

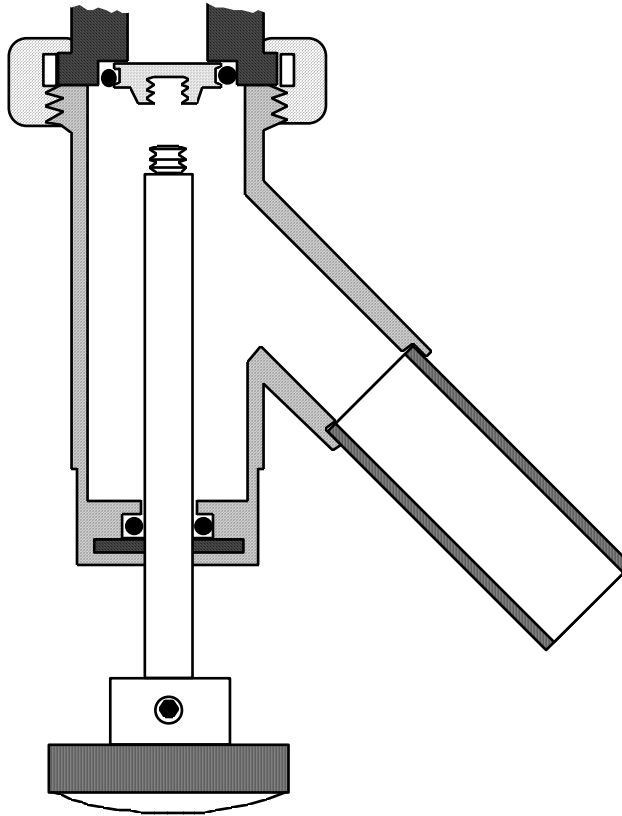

C-125-U-1-7

**Figure 1-7** Vacuum Valve Cutaway



# CHAPTER 2

## INSTALLATION

### 2.0 GENERAL

This chapter covers various aspects of MTD-120 installation: Inspection and Unpacking (Paragraph 2.1), Repackaging for Shipment (Paragraph 2.2), Environmental Requirements (Paragraph 2.3), System Power and Ground Requirements (Paragraph 2.4), Physical Support Requirements (Paragraph 2.5) Liquid cryogen Requirements (Paragraph 2.6), Instrument Hookup Instructions (Paragraph 2.7), Miscellaneous Precautions (Paragraph 2.8), and the Procedure for Device Under Test (DUT) Insertion (Paragraph 2.9).

### 2.1 INSPECTING AND UNPACKING

Inspect the shipping container for external damage. Make all claims for damage (apparent or concealed) or partial loss of shipment in writing to Lake Shore within five (5) days from receipt of goods. If damage or loss is apparent, notify the shipping agent immediately.

Open the shipping containers. Locate the MTD-120 packing list and use it to check for receipt of all components, cables, accessories, and manuals. Inspect each item for damage. Retain internal packing material and box for reshipment. Fill out and mail the warranty card.

If there is freight damage to any instruments, promptly file proper claims with the carrier and insurance company and notify Lake Shore Cryotronics. Notify Lake Shore of any missing parts immediately. Lake Shore cannot be responsible for any missing parts unless notified within 60 days of shipment. See the standard Lake Shore Cryotronics, Inc. Warranty on the A Page (immediately behind the title page).

### 2.2 REPACKAGING FOR SHIPMENT

To return any part of the MTD-120 for repair or replacement, obtain a Return Goods Authorization (RGA) number from a factory representative before returning the instrument to our service department. When returning an instrument for service, Lake Shore requires the following information before attempting any repair:

1. Instrument model and serial number
2. User's name, company, address, and phone number
3. Malfunction symptoms
4. Description of system
5. Returned Goods Authorization number

Consult the factory for shipping instructions. Ship the MTD-120 in the original shipping box.

### 2.3 ENVIRONMENTAL REQUIREMENTS

Operate the MTD-120 in an area with an ambient temperature range of 18 to 28 °C (64.4 to 82.4 °F). The unit may be operated within the range of 15 to 35 °C (59 to 95 °F) with reduced accuracy.

The MTD-120 is intended for laboratory use: no specific humidity or altitude specifications have been determined. However, relative humidity of 20 to 80 percent (no condensation) and altitudes from sea level to 2.4 km (8,000 feet) are generally acceptable.

**WARNING: To prevent electrical fire or shock hazards, do not expose this instrument to moisture.**

Provide adequate ventilation. See Forward for cryogenic safety instructions. Filter dust and other particulate matter at the site to a reasonable level. For salt air, corrosive gases, or other air pollutants, consult an air-conditioning expert for special filtering arrangements.

## 2.4 POWER AND GROUND REQUIREMENTS

The AC power source for the MTD-120 should be frequency and voltage regulated and isolated from sources that may generate Electromagnetic Interference (EMI). The MTD-120 is designed for single-phase 3-wire alternating current (AC) power; do not use two-wire (without ground) AC power. Lake Shore recommends Ground Fault Interrupter (GFI) and Transient Surge Protection circuitry at the AC source.

In areas where AC voltage varies, consider using a constant voltage transformer. For power outages, consider using an Uninterruptible Power Supply (UPS).

**CAUTION: Do not attempt to apply electrical power until the MTD-120 is checked for proper line voltage settings.**

Factory-preset MTD-120 line voltage requirements allow proper operation at the shipping destination. The line voltage setting is indicated on the rear panel. Before applying power to the main input power cable, check for correct input power settings for the power source voltage.

Ground the instrument panels and cabinets. The safety ground provides a true ground path for electrical circuitry and, in the event of internal electrical faults such as shorts, carries the entire fault current to ground to protect users from electrical shock. The MTD-120 has a three-conductor power input connector which grounds instrument console equipment when plugged into a 3-wire receptacle.

EMI is both a natural and man-made electromagnetic phenomena which, either directly or indirectly, may degrade electronic system performance. Natural EMI includes thunderstorms, solar disturbances, cosmic rays, etc. Man-made EMI includes fixed and mobile transmitters, high voltage power lines, power tools and appliances, florescent lights, and other equipment containing motors, heaters, etc. Protect the AC source from EMI. Consider transient surge protectors for lightning protection.

## 2.5 PHYSICAL SUPPORT REQUIREMENTS

Stabilize the MTD to prevent the system from tipping over or falling, especially during transfer of liquid cryogen. The preferred method for the MTD-120 is to clamp the mounting base to the table surface. The preferred method for the Model MTD-121 is to mount the system on a stable tripod.

## 2.6 LIQUID CRYOGEN

The standard Model MTD-120 Cryostat is designed for use with liquid nitrogen.

## 2.7 INSTRUMENTATION HOOKUP INSTRUCTIONS

It is recommended the MTD-120 be used with the Model 330 Autotuning Temperature Controller. Figure 2-1 details the Model 8271-30M-6 Cable Assembly hookup to the Model 330. See Figure 4.1 for cable assembly definition.

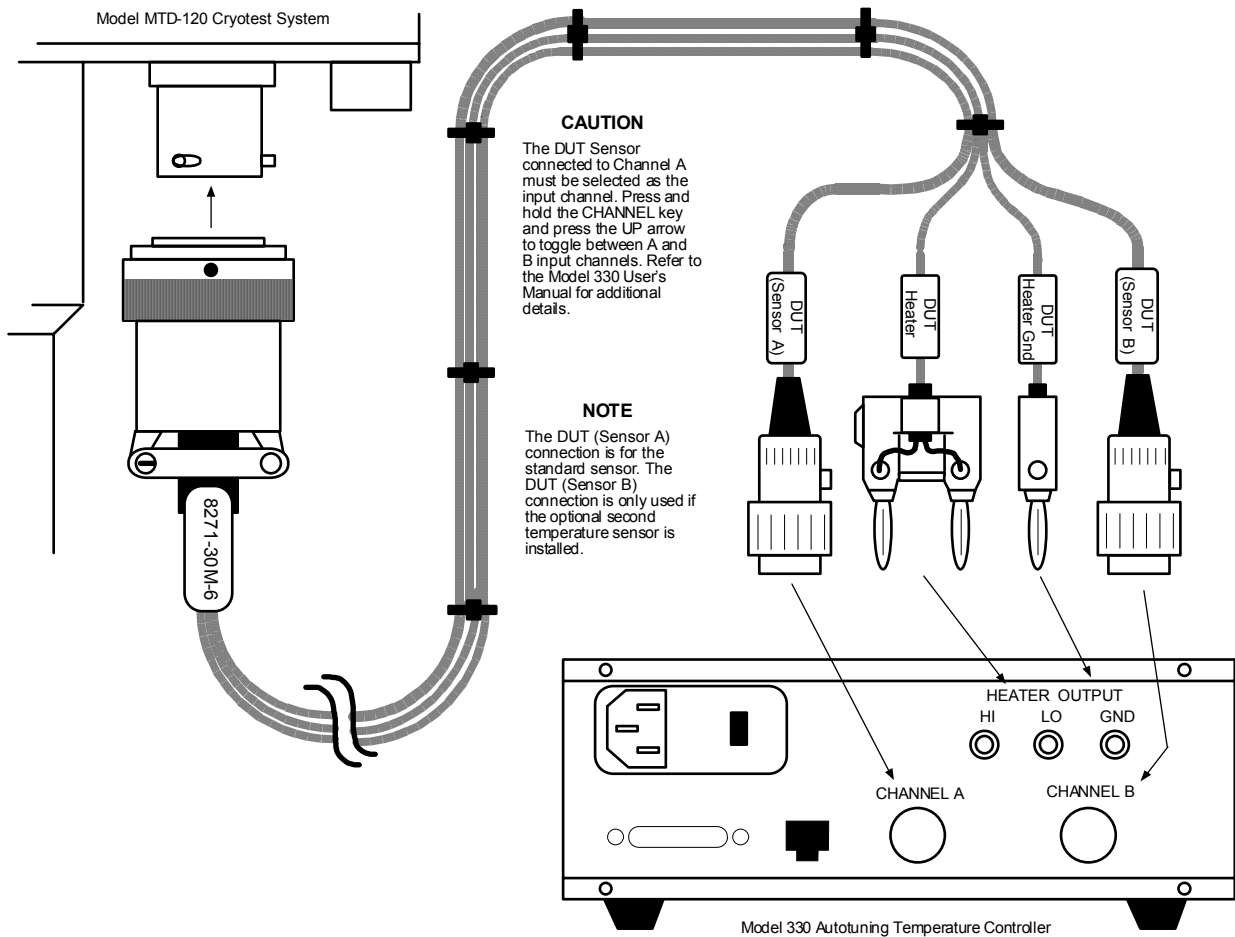

Figure 2-1 MTD-120 Hookup to the Model 330 Temperature Controller

## 2.8 MISCELLANEOUS PRECAUTIONS

- Heater power should not exceed 80 watts.
- Never heat the DUT mount or any part of the MTD-120 above 100 °C.
- Do not “break” vacuum in the chamber while the system is cold.
- Avoid contact with cold gas when depressurizing the storage dewar.
- Periodically clean routinely accessed o-ring seals and their mating surfaces with a paper wipe and re-grease with Apiezon® “N” grease.

## 2.9 DEVICE UNDER TEST (DUT) INSERTION

1. Stabilize the MTD-120 System at room temperature and remove the transfer line.
2. Open the cryostat vacuum pumpout valve to vent system.
3. Release the 2 pull-down clamps and remove the vacuum chamber enclosure.  
**NOTE:** Place vacuum chamber enclosure with the o-ring face up to prevent damage.
4. Remove radiation shield by unscrewing the six captive socket head screws.
5. Remove the chip carrier clamp assembly held in place by 4 captive socket head screws.
6. Place the DUT in the device socket on the fan out board and ensure that its contacts line up with the socket contacts.
7. Carefully place the chip carrier clamp assembly over the DUT and check that it compresses the DUT into the socket without binding.
8. Replace the chip carrier clamp assembly mounting screws in a 1–3–2–4 sequence to ensure uniform clamping pressure.  
**CAUTION: Do not over tighten screws or completely tighten one at a time. Tighten each screw one-half turn, continuously repeating the 1–3–2–4 sequence until all four screws are snug.**
9. Replace the radiation shield.
10. Clamp down the vacuum chamber enclosure.

## CHAPTER 3

# OPERATION

### 3.0 GENERAL

This chapter describes MTD-120 Cryotest System operation (Paragraph 3.1) and shutdown (Paragraph 3.2). Read the entire manual before continuing, and verify all instruments work correctly prior to system operation.

### 3.1 MTD SYSTEM OPERATION

- To evacuate vacuum chamber, attach suitable nitrogen-trapped vacuum pumping system capable of <20 millitorr to vacuum port. Turn on vacuum pump.  
**CAUTION: When venting or pumping out the system, release the vacuum slowly. A sudden vacuum release may damage the aluminized Mylar insulation.**
- Slowly open cryostat vacuum pumpout valve. A clean system reaches 20 millitorr in 15 to 20 minutes.  
**CAUTION: Do not pump on MTD System when cold or contamination from pumping system may "cryopump" onto cold surfaces. Do not vent and back fill system with gas during warm-up.**
- Fully close valve pumpout valve and disconnect vacuum line.
- Connect Model 8271-30M-6 Instrumentation Cable to 6-pin instrumentation feedthrough connector located on underside of the MTD-120 vacuum chamber.

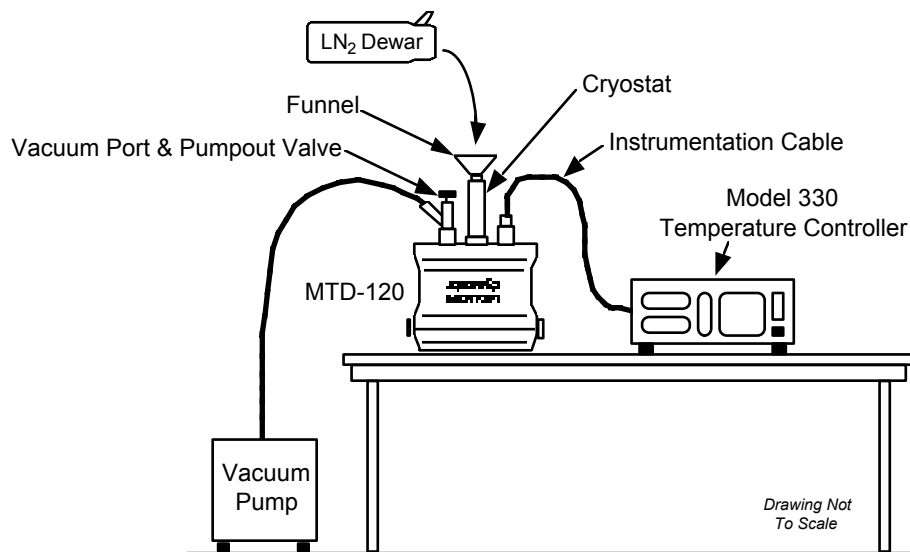

**Figure 3-1** Typical MTD-120 Cryotest System Operational Setup

- Connect other end of Instrumentation Cable to Temperature Controller. See Figure 2-1 for hookup to the Model 330 Autotuning Temperature Controller. Consult the Model 330 Temperature Controller User's Manual for controller operation.
- Position cryostat so the fill port points up.

#### CAUTION

- Start with small amounts of liquid nitrogen when initially pouring into a warm dewar. Too much liquid too fast can cause a violent boil over.
- Read and observe all liquid nitrogen safety precautions detailed in the Forward.

7. Using a funnel, slowly pour LN<sub>2</sub> into the reservoir thru the fill port.
8. Stop filling when excess cryogen begins to overflow. Pour in more LN<sub>2</sub> when the boil off gas slows.
9. Stop when the LN<sub>2</sub> reaches the top of the fill port.
10. Wait for system cool down to desired temperature. Typical cool down time is about 15 minutes to 80 K.
11. To connect Customer instrumentation to the DUT signal lines, connect appropriate cables to four 34-pin feedthrough connectors on vacuum chamber base plate. Connectors are labeled A, B, C, and D. A typical 340-pin connector is illustrated in Figure 1-5. The MTD-120 is now ready to perform tests.

**NOTE**

- Although the instrumentation connectors have 34 pins, there are only 17 signal lines per connector. Twenty-five signal lines times four connectors equals the one hundred connections on the fanout board. When viewing the instrumentation connector as shown in Figure 1-5, the inner row of 17 pins for signals from the DUT. The outer row of 17 pins has connections for the shields. The shield pin corresponds to the signal pin directly adjacent to it.
- Other wiring configurations are possible per Customer Order. Consult the factory with questions concerning alternative wiring configurations.

**3.2 MTD SYSTEM SHUTDOWN**

At the completion of the test, the steps below ensure proper system shutdown and avoid contamination of the DUT by water vapor or other contaminants.

1. Disconnect all cables.
2. Turn MTD over and empty LN<sub>2</sub> from reservoir into a cryogenic storage dewar.
3. Place MTD back on the table. Cover the fill port to prevent internal condensation.
4. Reconnect cables to the Model 330 Temperature Controller. Wait for the system to warm up before opening. Turn the internal heater on to speed warming (see the Model 330 User's Manual).

**NOTE**

- In order to prevent condensation of moisture, do not open the MTD System until all internal parts are at room temperature. Because the MTD is designed to be thermally efficient, this will take several hours without assistance.
- Do not vent and back-fill system with gas for a rapid warm-up.

# CHAPTER 4

## SERVICE

### 4.0 GENERAL

This chapter covers possible difficulties that may occur. Read the entire manual before attempting to service the MTD-120 System. Please contact the factory with any questions or concerns.

### 4.1 WATER CONDENSES ON OUTER SURFACE OF VACUUM CHAMBER

If the vacuum chamber “sweats,” check the vacuum integrity of the chamber.

### 4.2 UNABLE TO REACH COLD TERMINAL TEMPERATURE

This may be caused by any of the following:

- Experimental heat load too high.
- Improper anchoring of instrumentation and DUT lines or poor wiring practices.
- “Soft” vacuum in the vacuum chamber or transfer line.
- Thermal short between DUT and radiation shield or radiation shield and vacuum chamber.
- Poor interfacing between DUT and mount and/or between temperature sensor and cold finger.
- Insufficient cryogen in reservoir.

### 4.3 NO RESPONSE TO CONTROL HEATER

Check the cables to the 6-pin instrumentation feedthrough located on the cryostat main body, the power supply, and controller. Check the heater lines with an ohmmeter. If approximately 50  $\Omega$  are not measured, verify correct wiring. Otherwise, replace the heater. Consult the factory for instructions.

### 4.4 CABLE ASSEMBLY

Details of the optional Cable Assembly P/N 8271-30M-6 that connects a MTD-120 with a Lake Shore Model 330 Autotuning Temperature Controller appear in Figure 4-1

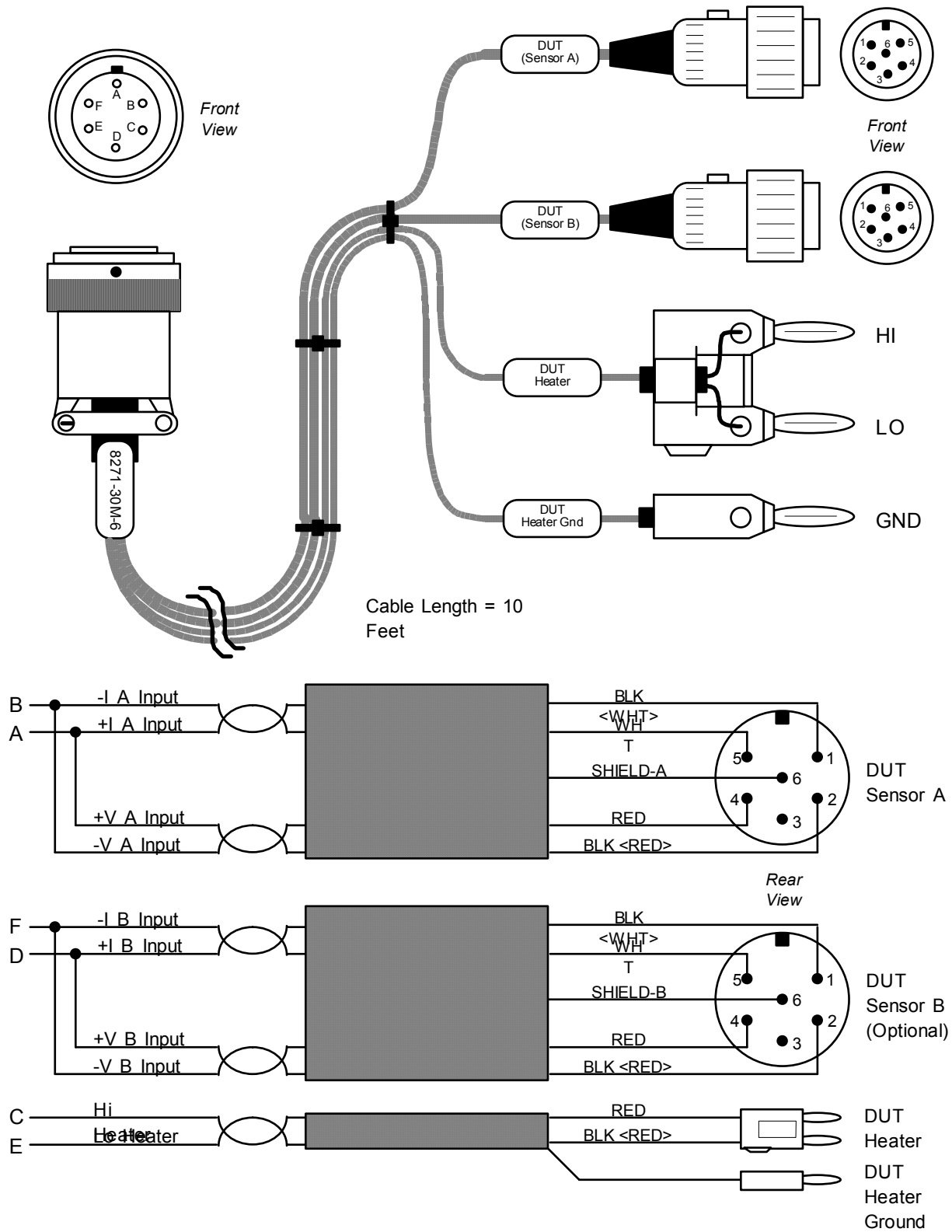

Figure 4-1 Definition of Model 8271-30M-6 Cable Assembly



## CHAPTER 5

# ERROR MESSAGES AND TROUBLESHOOTING

### 5.0 GENERAL

This chapter lists MTD-120 Cryotest System Options (Paragraph 5.1) and Accessories (Paragraph 5.2).

### 5.1 MTD CRYOTEST SYSTEM OPTIONS

The MTD-120 Cryotest System comes in the two standard configurations detailed below. Lake Shore tailors the MTD Cryotest System to fit custom applications. Contact Lake Shore for details.

- **MTD-120:** Liquid Nitrogen (LN<sub>2</sub>), single-position, pour-fill, down-looking cryostat system.
- **MTD-121:** Liquid Nitrogen (LN<sub>2</sub>), single-position, pour-fill, side-looking cryostat system.

### 5.2 ACCESSORIES

Accessories are devices that perform a secondary duty as an aid or refinement to the primary unit. Other accessories not listed (signal cable assemblies, breakout boxes, filters/apertures, etc.) are added on an as required basis. Consult the factory for current availability of other accessories not listed below.

MODEL NUMBER	DESCRIPTION OF ACCESSORY
1550	<b>DT-470 sensor and chip heater pre-mounted in a Customer Supplied Leadless Chip Carrier (LCC) Mounting Base.</b> This is a service provided by Lake Shore for Customers who want one of their own LCC mounting bases configured with a temperature sensor and heater. This accessory normally uses a Lake Shore Model DT-470-SD-12 silicon diode temperature sensor. Please contact Lake Shore for further information on this service.
330	<b>Model 330 Autotuning Temperature Controller.</b> The Lake Shore Model 330 is a full featured digital control unit featuring Autotuning and SoftCal™. Please consult the Lake Shore Product Catalog for configuration, option, and accessory details.
8271-30M-6	<b>Instrumentation Interconnection Cable for Model 330 Autotuning Temperature Controller.</b>
9001-00X	<b>Lake Shore Cryogenic Wire.</b> Lake Shore sell the following types of cryogenic wire: DT = Duo-Twist™, MN = Single Strand, MW = Manganin, NC = Nichrome Heater, ND = Heavy Duty, QL = Quad-Lead™, and QT = Quad-Twist™. Please refer to the Lake Shore Catalog for wire details.
9002-432	<b>CryoCable™ 4 x 32 AWG.</b> A robust, 4-wire superconductive cable for use in applications ranging from cryogenic to room temperature. The CryoCable™ was designed by Lake Shore for Customers with demanding installations. Available in 25, 50, and 100 foot lengths.
9004-020	<b>Apiezon® "N" Grease, 25 gram Tube.</b> General purpose grease well-suited for cryogenic use because of its low viscosity. It is often used as a means of thermally anchoring cryogenic sensors as well as lubricating joints and o-rings. Contains high molecular weight polymeric hydrocarbon additive which give it a tenacious, rubbery consistency allowing the grease to form a cushion between mating surfaces.
9007-002	<b>Indium Foil (5 Pieces).</b> Indium is a semi-precious non-ferrous metal, softer than lead, and extremely malleable and ductile. It stays soft and workable down to cryogenic temperatures. May be used as a sealing gasket for covers, flanges, and windows in cryogenic applications.

This Page Intentionally Left Blank

## APPENDIX A

## UNITS FOR MAGNETIC PROPERTIES

<b>Conversion from CGS to SI Units</b>				
Quantity	Symbol	Gaussian & CGS emu <sup>a</sup>	Conversion Factor, C <sup>b</sup>	SI & Rationalized mks <sup>c</sup>
Magnetic flux density, Magnetic induction	B	gauss (G) <sup>d</sup>	10 <sup>-4</sup>	tesla (T), Wb/m <sup>2</sup>
Magnetic Flux	Φ	maxwell (Mx), G•cm <sup>2</sup>	10 <sup>-8</sup>	weber (Wb), volt second (V•s)
Magnetic potential difference, magnetomotive force	U, F	gilbert (Gb)	10/4π	ampere (A)
Magnetic field strength, magnetizing force	H	oersted (Oe), <sup>e</sup> Gb/cm	10 <sup>3</sup> /4π	A/m <sup>f</sup>
(Volume) magnetization <sup>g</sup>	M	emu/cm <sup>3h</sup>	10 <sup>3</sup>	A/m
(Volume) magnetization	4πM	G	10 <sup>3</sup> /4π	A/m
Magnetic polarization, intensity of magnetization	J, I	emu/cm <sup>3</sup>	4π x 10 <sup>-4</sup>	T, Wb/m <sup>2i</sup>
(Mass) magnetization	σ, M	emu/g	1 4π x 10 <sup>-7</sup>	A•m <sup>2</sup> /kg Wb•m/kg
Magnetic moment	m	emu, erg/G	10 <sup>-3</sup>	A•m <sup>2</sup> , joule per tesla (J/T)
Magnetic dipole moment	j	emu, erg/G	4π x 10 <sup>-10</sup>	Wb•m <sup>1</sup>
(Volume) susceptibility	χ, κ	dimensionless emu/cm <sup>3</sup>	(4π) <sup>-2</sup> x 10 <sup>-7</sup>	Henry per meter (H/m), Wb/(A•m)
(Mass) susceptibility	χ <sub>p</sub> , κ <sub>p</sub>	cm <sup>3</sup> /g, emu/g	4π x 10 <sup>-3</sup> (4π) <sup>2</sup> x 10 <sup>-10</sup>	m <sup>3</sup> /kg H•m <sup>2</sup> /kg
(Molar) susceptibility	χ <sub>mol</sub> , κ <sub>mol</sub>	cm <sup>3</sup> /mol, emu/mol	4π x 10 <sup>-6</sup> (4π) <sup>2</sup> x 10 <sup>-13</sup>	m <sup>3</sup> /mol H•m <sup>2</sup> /mol
Permeability	μ	dimensionless	4π x 10 <sup>-7</sup>	H/m, Wb/(A•m)
Relative permeability <sup>j</sup>	μ <sub>r</sub>	not defined	-	dimensionless
(Volume) energy density, energy product <sup>k</sup>	W	erg/cm <sup>3</sup>	10 <sup>-1</sup>	J/m <sup>3</sup>
Demagnetization factor	D, N	dimensionless	1/4π	dimensionless

**NOTES:**

- Gaussian units and cgs emu are the same for magnetic properties. The defining relation is  $B = H + 4\pi M$ .
- Multiply a number in Gaussian units by C to convert it to SI (e.g.  $1 \text{ G} \times 10^{-4} \text{ T/G} = 10^{-4} \text{ T}$ ).
- SI (Système International d'Unités) has been adopted by the National Bureau of Standards. Where two conversion factors are given, the upper one is recognized under, or consistent with, SI and is based on the definition  $B = \mu_0(H + M)$ , where  $\mu_0 = 4\pi \times 10^{-7} \text{ H/m}$ . The lower one is not recognized under SI and is based on the definition  $B = \mu_0 H + J$ , where the symbol I is often used in place of J.
- $1 \text{ gauss} = 10^5 \text{ gamma } (\gamma)$ .
- Both oersted and gauss are expressed as  $\text{cm}^{-3/2} \cdot \text{g}^{1/2} \cdot \text{s}^{-1}$  in terms of base units.
- A/m was often expressed as "ampere-turn per meter" when used for magnetic field strength.
- Magnetic moment per unit volume.
- The designation "emu" is not a unit.
- Recognized under SI, even though based on the definition  $B = \mu_0 H + J$ . See footnote c.
- $\mu_r = \mu/\mu_0 = 1 + \chi$ , all in SI.  $\mu_r$  is equal to Gaussian  $\mu$ .
- $B \cdot H$  and  $\mu_0 M \cdot H$  have SI units  $\text{J/m}^3$ ,  $\text{M} \cdot \text{H}$  and  $B \cdot H/4\pi$  have Gaussian units  $\text{erg/cm}^3$ .

R.B. Goldfarb and F.R. Fickett, U.S. Department of Commerce, National Bureau of Standards, Boulder, Colorado 80303, March 1985, NBS Special Publication 696. For sale by the Superintendent of Documents, U.S. Government Printing Office, Washington, D.C. 20402.

This Page Intentionally Left Blank