



---

## User's Manual

# Model 231/231P Temperature Transmitter

### **Includes Coverage for:**

*Model 2308-01 Benchtop Enclosure*

*Model 2308-12 VMEbus Rackmount Case*

### **For Use With The Following Lake Shore Sensors:**

*Model DT-414 Unencapsulated Silicon Diode Temperature Sensors*

*Series DT-420 Miniature Silicon Diode Temperature Sensors*

*Series DT-470 Silicon Diode Temperature Sensors*

*Series DT-471 Silicon Diode Temperature Sensors*

*Series DT-670 Silicon Diode Temperature Sensors*

*Series PT-100 Platinum Resistance Thermometers*

*Series TG-120 GaAlAs Diode Temperature Sensors*



Lake Shore Cryotronics, Inc.

575 McCorkle Boulevard

Westerville, Ohio 43082-8888 USA

E-Mail Addresses:

[sales@lakeshore.com](mailto:sales@lakeshore.com)

[service@lakeshore.com](mailto:service@lakeshore.com)

Visit Our Website:

[www.lakeshore.com](http://www.lakeshore.com)

Fax: (614) 891-1392

Telephone: (614) 891-2243

Methods and apparatus disclosed and described herein have been developed solely on company funds of Lake Shore Cryotronics, Inc. No government or other contractual support or relationship whatsoever has existed which in any way affects or mitigates proprietary rights of Lake Shore Cryotronics, Inc. in these developments. Methods and apparatus disclosed herein may be subject to U.S. Patents existing or applied for. Lake Shore Cryotronics, Inc. reserves the right to add, improve, modify, or withdraw functions, design modifications, or products at any time without notice. Lake Shore shall not be liable for errors contained herein or for incidental or consequential damages in connection with furnishing, performance, or use of this material.

**LIMITED WARRANTY STATEMENT – WARRANTY PERIOD: THREE (3) YEAR**

1. Lake Shore warrants that products manufactured by Lake Shore (the "Product") will be free from defects in materials and workmanship for three years from the date of Purchaser's physical receipt of the Product (the "Warranty Period"). If Lake Shore receives notice of any such defects during the Warranty Period and the defective Product is shipped freight prepaid back to Lake Shore, Lake Shore will, at its option, either repair or replace the Product (if it is so defective) without charge for parts, service labor or associated customary return shipping cost to the Purchaser. Replacement for the Product may be by either new or equivalent in performance to new. Replacement or repaired parts, or a replaced Product, will be warranted for only the unexpired portion of the original warranty or 90 days (whichever is greater).
  2. Lake Shore warrants the Product only if the Product has been sold by an authorized Lake Shore employee, sales representative, dealer or an authorized Lake Shore original equipment manufacturer (OEM).
  3. The Product may contain remanufactured parts equivalent to new in performance or may have been subject to incidental use when it is originally sold to the Purchaser.
  4. The Warranty Period begins on the date of Purchaser's physical receipt of the Product or later on the date of operational training and verification (OT&V) of the Product if the service is performed by Lake Shore, provided that if the Purchaser schedules or delays the Lake Shore OT&V for more than 30 days after delivery then the Warranty Period begins on the 31st day after Purchaser's physical receipt of the Product.
  5. This limited warranty does not apply to defects in the Product resulting from (a) improper or inadequate installation (unless OT&V services are performed by Lake Shore), maintenance, repair or calibration, (b) fuses, software, power surges, lightning and non-rechargeable batteries, (c) software, interfacing, parts or other supplies not furnished by Lake Shore, (d) unauthorized modification or misuse, (e) operation outside of the published specifications, (f) improper site preparation or site maintenance (g) natural disasters such as flood, fire, wind, or earthquake, or (h) damage during shipment other than original shipment to you if shipped through a Lake Shore carrier.
  6. This limited warranty does not cover: (a) regularly scheduled or ordinary and expected recalibrations of the Product; (b) accessories to the Product (such as probe tips and cables, holders, wire, grease, varnish, feed throughs, etc.); (c) consumables used in conjunction with the Product (such as probe tips and cables, probe holders, sample tails, rods and holders, ceramic putty for mounting samples, Hall sample cards, Hall sample enclosures, etc.); or, (d) non-Lake Shore branded Products that are integrated with the Product.
  7. To the extent allowed by applicable law,, this limited warranty is the only warranty applicable to the Product and replaces all other warranties or conditions, express or implied, including, but not limited to, the implied warranties or conditions of merchantability and fitness for a particular purpose. Specifically, except as provided herein, Lake Shore undertakes no responsibility that the products will be fit for any particular purpose for which you may be buying the Products. Any implied warranty is limited in duration to the warranty period. No oral or written information, or advice given by the Company, its Agents or Employees, shall create a warranty or in any way increase the scope of this limited warranty. Some countries, states or provinces do not allow limitations on an implied warranty, so the above limitation or exclusion might not apply to you. This warranty gives you specific legal rights and you might also have other rights that vary from country to country, state to state or province to province.
  8. Further, with regard to the United Nations Convention for International Sale of Goods (CISG,) if CISG is found to apply in relation to this agreement, which is specifically disclaimed by Lake Shore, then this limited warranty excludes warranties that: (a) the Product is fit for the purpose for which goods of the same description would ordinarily be used, (b) the Product is fit for any particular purpose expressly or impliedly made known to Lake Shore at the time of the conclusion of the contract. (c) the Product is contained or packaged in a manner usual for such goods or in a manner adequate to preserve and protect such goods where it is shipped by someone other than a carrier hired by Lake Shore.
  9. Lake Shore disclaims any warranties of technological value or of non-infringement with respect to the Product and Lake Shore shall have no duty to defend, indemnify, or hold harmless you from and against any or all damages or costs incurred by you arising from the infringement of patents or trademarks or violation or copyrights by the Product.
  10. THIS WARRANTY IS NOT TRANSFERRABLE. This warranty is not transferrable.
  11. Except to the extent prohibited by applicable law, neither Lake Shore nor any of its subsidiaries, affiliates or suppliers will be held liable for direct, special, incidental, consequential
-



---

or other damages (including lost profit, lost data, or downtime costs) arising out of the use, inability to use or result of use of the product, whether based in warranty, contract, tort or other legal theory, regardless whether or not Lake Shore has been advised of the possibility of such damages. Purchaser's use of the Product is entirely at Purchaser's risk. Some countries, states and provinces do not allow the exclusion of liability for incidental or consequential damages, so the above limitation may not apply to you.

12. This limited warranty gives you specific legal rights, and you may also have other rights that vary within or between jurisdictions where the product is purchased and/or used. Some jurisdictions do not allow limitation in certain warranties, and so the above limitations or exclusions of some warranties stated above may not apply to you.

Except to the extent allowed by applicable law, the terms of this limited warranty statement do not exclude, restrict or modify the mandatory statutory rights applicable to the sale of the product to you.

#### **CERTIFICATION**

Lake Shore certifies that this product has been inspected and tested in accordance with its published specifications and that this product met its published specifications at the time of shipment. The accuracy and calibration of this product at the time of shipment are traceable to the United States National Institute of Standards and Technology (NIST); formerly known as the National Bureau of Standards (NBS), or to a recognized natural standard.

#### **TRADEMARK ACKNOWLEDGEMENT**

Manufacturers and sellers claim many designations as trademarks to distinguish their products. Where those designations appear in this manual and Lake Shore was aware of a trademark claim, the designations appear in initial capital letters with a <sup>TM</sup> or <sup>®</sup> symbol.

Apiezon<sup>®</sup> is a trademark of Biddle Instruments.

CalCurve<sup>™</sup>, Carbon-Glass<sup>™</sup>, Cernox<sup>™</sup>, Duo-Twist<sup>™</sup>, High-Temperature Cernox<sup>™</sup>, Quad-Lead<sup>™</sup>, Quad-Twist<sup>™</sup>, Rox<sup>™</sup>, SoftCal<sup>™</sup>, and Thermox<sup>™</sup> are trademarks of Lake Shore Cryotronics, Inc.

Teflon<sup>®</sup> is a trademark of DuPont De Nemours.

Copyright © 1993, 1998-99, 2001, 2004, 2012-13 by Lake Shore Cryotronics, Inc. All rights reserved. No portion of this manual may be reproduced, stored in a retrieval system, or transmitted, in any form or by any means, electronic, mechanical, photocopying, recording, or otherwise, without express written permission of Lake Shore.





## DECLARATION OF CONFORMITY

We: **Lake Shore Cryotronics, Inc.**  
**575 McCorkle Blvd.**  
**Westerville, OH 43082 USA**

hereby declare that the equipment specified conforms to the following Directives and Standards:

Application of Council Directives..... **2004/108/EC EMC**

Standards to which Conformity is declared..... **EN 55022:2010**  
**EN 61000-6-1:2007**

Model Number..... **231**

 *10/3/2013*  
**Scott Ayer**

**Director of Quality and Compliance**  
*Position*



## TABLE OF CONTENTS

<i>Chapter/Paragraph</i>	<i>Title</i>	<i>Page</i>
<b>1</b>	<b>INTRODUCTION.....</b>	<b>1-1</b>
1.0	General.....	1-1
1.1	Model 231 System Description .....	1-1
1.2	Single Enclosure Case Description.....	1-6
1.3	Multiple Unit Enclosure Case Description .....	1-7
<b>2</b>	<b>INSTALLATION.....</b>	<b>2-1</b>
2.0	General.....	2-1
2.1	Inspection and Unpacking.....	2-1
2.2	Repackaging For Shipment .....	2-1
2.3	Sensor Installation Recommendations.....	2-2
2.3.1	Two-Lead vs. Four-Lead Measurements.....	2-2
2.3.1.1	Two-Lead Measurements .....	2-2
2.3.1.2	Four-Lead Measurements .....	2-3
2.3.2	Connecting Leads To The Sensor.....	2-3
2.3.3	Sensor Mounting .....	2-3
2.3.4	Measurement Errors Due To AC Noise.....	2-4
2.4	Sensor Curve Definition.....	2-5
2.5	Power Connections.....	2-6
<b>3</b>	<b>OPERATION.....</b>	<b>3-1</b>
3.0	General.....	3-1
3.1	PCB DIP Switch Settings .....	3-1
3.2	Output to Temperature Conversion .....	3-2
<b>4</b>	<b>SERVICE .....</b>	<b>4-1</b>
4.0	General.....	4-1
4.1	General Troubleshooting .....	4-1
4.1.1	No Output (On-Board LED Off) .....	4-1
4.1.2	Output Stops Before Reaching Upper Limit .....	4-1
4.1.3	Output Is Incorrect Value (Small Error) .....	4-1
4.1.4	Output Is Incorrect Value (Large Error) .....	4-2
4.2	Model 231 Connector Definitions.....	4-2
4.3	Calibration.....	4-3
4.3.1	Test Equipment Required.....	4-3
4.3.2	Reference Calibration.....	4-4
4.3.3	Output Calibration .....	4-5

## TABLE OF CONTENTS (Continued)

<i>Chapter/Paragraph</i>	<i>Title</i>	<i>Page</i>
<b>5</b>	<b>OPTIONS AND ACCESSORIES .....</b>	<b>5-1</b>
5.0	General .....	5-1
5.1	Enclosures .....	5-1
5.2	Options.....	5-1
5.3	Accessories.....	5-2
5.4	Wires.....	5-2
5.5	Sensors.....	5-3
5.6	Special Equipment.....	5-3
<b>APPENDIX A – MODEL 231 CURVE TABLES.....</b>		<b>A-1</b>
<b>APPENDIX B – GLOSSARY OF TERMINOLOGY .....</b>		<b>B-1</b>

## LIST OF ILLUSTRATIONS

<i>Figure No.</i>	<i>Title</i>	<i>Page</i>
1-1	Typical Model 231 Front Panel.....	1-2
1-2	Single Enclosure Case Physical Dimensions .....	1-6
1-3	Multiple Unit Case Physical Dimensions .....	1-8
2-1	Typical Wall Plug-In Power Supply .....	2-7
3-1	Model 231 DIP Switch (S1) .....	3-1
4-1	Front Panel Connectors J2 & J3 Details .....	4-2
4-2	VMEbus Connector J1 Details .....	4-3
4-3	Model 231 PCB Layout .....	4-4

## LIST OF TABLES

<i>Table No.</i>	<i>Title</i>	<i>Page</i>
1-1	Model 231 Input Specifications .....	1-3
1-2	Model 231P Input Specifications .....	1-4
1-3	Model 231 & 231P Output Specifications .....	1-5
1-4	Model 2308-12 VMEbus Rackmount Case Specs .....	1-7
2-1	Effect of Current Variation on Diode Temperature .....	2-5
2-2	Typical DT-470 dV/dI Values for Selected Temps.....	2-5
3-1	Conversion Parameters for Temperature in K.....	3-2
A-1	Lake Shore Standard Diode Curves.....	A-1
A-2	Series PT-100 Platinum Resistance Curve .....	A-2



# CHAPTER 1

## INTRODUCTION

### 1.0 GENERAL

Lake Shore Cryotronics designed and manufactures the Model 231 in the United States of America. In general, reference to the Model 231 means both the Model 231 and 231P. Specific references are made where appropriate. This chapter provides a general description with specifications in Paragraph 1.1, single-enclosure case description in Paragraph 1.2, and multiple-unit enclosure case description in Paragraph 1.3.

We welcome comments on this manual. Although we try to keep it error-free, some may occur. To report an error, describe it briefly and include the appropriate paragraph, figure, table, and page number. Send comments to Lake Shore Cryotronics, Attn: Technical Publications, 575 McCorkle Blvd., Westerville, Ohio 43082-8888. This manual is subject to change without notice.

### 1.1 MODEL 231 GENERAL DESCRIPTION

The Model 231 Temperature Transmitter is available as a stand-alone unit or for use within either of two enclosures: a Model 2308-1 single-space enclosure, or a Model 2308-12 rackmount case that holds up to 12 units.

The Model 231 Temperature Transmitter sends temperature data from its position near a sensor to a data acquisition channel or strip chart recorder. It operates with Silicon diode or Gallium-Aluminum-Arsenide (GaAlAs) diode sensors. Lake Shore Silicon diode sensors are accurate over a wide cryogenic temperature range and are interchangeable for some applications. The Lake Shore Series TG-120 GaAlAs diodes operate in a low to moderate magnetic field. Excited with a 10  $\mu\text{A}$  current source from the Model 231, the sensors produce a voltage that depends on temperature. A microcontroller reads the voltage through an A/D converter and translates it into temperature. Either the standard temperature curve or an optional CalCurve™ relates voltage to temperature (the Series TG-120 requires a CalCurve).

The Model 231P uses a Series PT-100 Platinum Thermometer. The Model 231P excites the sensor with a 500  $\mu\text{A}$  current to produce a measurable signal. Either the standard platinum curve (DIN 437600) or a CalCurve is used for temperature conversion.

Once the Model 231 obtains temperature data, it transmits it as a current from 4 to 20 mA. The current output changes linearly with sensor temperature. Output scale depends on the selected temperature range. Several switch selected ranges are available. For highest accuracy and sensitivity, set the output for a narrow temperature band. An optional 0 to 20 mA output is also available to convert output to a voltage reading scaled from zero. A  $500\ \Omega \pm 0.02\%$  precision resistor is provided for this purpose. This resistor produces the maximum full-scale output of 10 V.

A single +5 VDC supply powers Model 231 circuitry. The outputs are isolated so several 231s can operate from the same supply without interference. The +5 VDC can also be supplied from the pins on the VME bus connector.

Mechanical mounting is easy because the Model 231 is built on a standard size VME card. It fits directly into a single height (3U) VME card holder. The transmitter does not use the electrical bus format, only its physical shape and power supply.

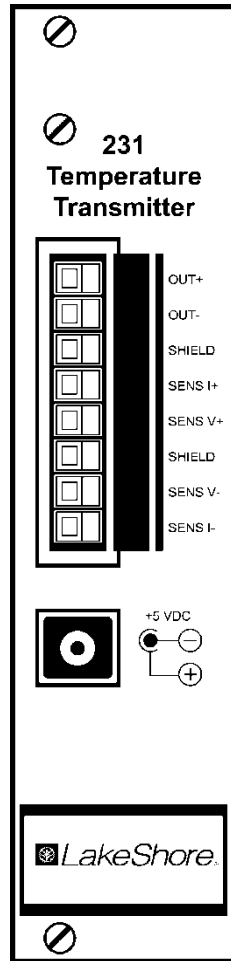

Figure 1-1. Typical Model 231 Front Panel

**Table 1-1. Model 231 Input Specifications****Thermometry:**

Number of Inputs: One input  
 Measurement Type: Four-lead differential  
 Sensor Type: Silicon diode, GaAlAs diode (to 5V)  
 Sensor Temp. Coefficient: Negative  
 Sensor Units: Volt (V)  
 Input Range: 0–5 volts  
 Sensor Excitation: 10  $\mu$ A  $\pm$ 0.1% DC current  
 Update Rate: 5 readings per second  
 CalCurve Storage: 1 curve, loaded in PROM at factory

**Example Lake Shore Sensor: DT-470-CO**

Temperature Range: 1.4 K–325 K with DT-470  
 Standard Curve: Curve 10  
 Typical Sensor Sensitivity: –30 mV/K at 4.2 K  
   –1.9 mV/K at 77.35 K  
   –2.4 mV/K at 300 K

**Measurement Resolution:**

Sensor Units: 76.3  $\mu$ V  
 Temp. Equivalence:                   2.5 mK at 4.2 K  
   40 mK at 77.35 K  
   32 mK at 300 K

**Measurement Accuracy:**

Sensor Units:  $\pm$ 75  $\mu$ V  $\pm$ 0.01% of reading  
 Temp. Accuracy \*:                    $\pm$ 0.07 K at 4.2 K  
    $\pm$ 0.16 K at 77.35 K  
    $\pm$ 0.12 K at 300 K

\* DT-470-CO with 8001 CalCurve.

**Measurement Temperature Coefficient:**

Sensor Units: 0.0006% of voltage reading per  $^{\circ}$ C  
 Temp. Equivalence:                   3 mK/ $^{\circ}$ C at 4.2 K  
   3 mK/ $^{\circ}$ C at 77.35 K  
   1.2 mK/ $^{\circ}$ C at 300 K

**Typical Performance With Series TG-120 Sensor:**

Similar to selected example diode sensor with improved measurement resolution and temperature resolution at temperatures of 4 K to 50 K. Sensor voltage must not exceed 5 V at lowest operating temperature.

**Table 1-2. Model 231P Input Specifications**

**Thermometry:**

Number of Inputs: One input  
 Measurement Type: Four-lead differential  
 Sensor Type: Platinum  
 Sensor Temp. Coefficient: Positive  
 Sensor Units: Ohm ( $\Omega$ )  
 Input Range: 0–312  $\Omega$   
 Sensor Excitation: 500  $\mu$ A  $\pm$ 0.02% DC current  
 Update Rate: 5 readings per second.  
 CalCurve Storage: 1 curve, loaded in PROM at factory.

**Example Lake Shore Sensor: PT-103**

Temperature Range: 14 K–873 K with PT-103  
 Standard Curve: DIN 43760  
 Typical Sensor Sensitivity: 0.19  $\Omega$ /K @ 30 K  
   0.42  $\Omega$ /K @ 77.35 K  
   0.39  $\Omega$ /K @ 300 K  
   0.34  $\Omega$ /K typical up to 800 K

**Measurement Resolution:**

Sensor Units: 4.8 m $\Omega$   
 Temp. Equivalence:           22 mK at 30 K  
   11 mK at 77.35 K  
   13 mK at 300 K  
   14 mK typical up to 800 K

**Measurement Accuracy:**

Sensor Units: Ohms ( $\Omega$ )  
 Temp. Accuracy:            $\pm$ 0.2 K at 30 K  
    $\pm$ 0.15 K at 77.35 K  
    $\pm$ 0.3 K at 300 K  
    $\pm$ 0.7 K typical up to 800 K

**Measurement Temperature Coefficient:**

Sensor Units: 0.002% of voltage reading per  $^{\circ}$ C  
 Temp. Equivalence:       0.4 mK/ $^{\circ}$ C at 30 K  
   1 mK/ $^{\circ}$ C at 77.35 K  
   6 mK/ $^{\circ}$ C at 300 K  
   18 mK/ $^{\circ}$ C at 800 K

**Magnetic Field Use:** Up to 19 teslas for T > 30 K.

**Table 1-3. Model 231 and 231P Output Specifications**

**Output:**

Number of Outputs: One

Output Type: Current source, isolated from power source but not sensor input

Output Range: 4–20 mA or 0–20 mA (for 0–10 V with provided 500 Ω, 0.02%, 25 ppm resistor)

Output Compliance: 10 V (500 Ω max load)

Output Temperature Ranges: 0–20 K, 0–100 K, 0–200 K, 0–325 K, 0–475 K, and 0–1000 K

**4–20 mA Output:**

*Output Resolution:*

Current: ±1.22 μA ±0.006% of full scale

Temp. Equivalence:	0–20 K = 1.5 mK	0–325 K = 24.8 mK
	0–100 K = 7.6 mK	0–475 K = 36.2 mK
	0–200 K = 15.3 mK	0–1000 K = 76.3 mK

*Output Accuracy:*

Current: ±2 μA ±0.01% of full scale

Temp. Equivalence:	0–20 K = 2.5 mK	0–325 K = 41 mK
	0–100 K = 12.5 mK	0–475 K = 59 mK
	0–200 K = 25 mK	0–1000 K = 125 mK

*Output Temperature Coefficient:*

Current (% output/°C ambient): ±0.0055%/°C

Temp. Equivalence:	0–20 K = 1 mK/°C	0–325 K = 18 mK/°C
	0–100 K = 6 mK/°C	0–475 K = 26 mK/°C
	0–200 K = 12 mK/°C	0–1000 K = 55 mK/°C

**0–20 mA Output (0–10 V w/500 Ω, 0.02% Load Resistor):**

*Output Resolution:*

Voltage: 0.6 mV ±0.006% of full scale

Temp. Equivalence:	0–20 K = 1.2 mK	0–325 K = 19.8 mK
	0–100 K = 6.1 mK	0–475 K = 29 mK
	0–200 K = 12.2 mK	0–1000 K = 61 mK

*Output Accuracy:*

Voltage: ±3 mV ±0.03% of full scale

Temp. Equivalence:	0–20 K = 6 mK	0–325 K = 98 mK
	0–100 K = 30 mK	0–475 K = 143 mK
	0–200 K = 60 mK	0–1000 K = 300 mK

*Output Temperature Coefficient:*

Voltage (% Output/°C ambient): ±0.008%/°C

Temp. Equivalence:	0–20 K = 2 mK/°C	0–325 K = 26 mK/°C
	0–100 K = 8 mK/°C	0–475 K = 38 mK/°C
	0–200 K = 16 mK/°C	0–1000 K = 80 mK/°C

**Table 1-3 Model 231 & 231P Output Specifications (Continued)**

<p><b>General:</b>                  Ambient Temperature Range: 15–35 °C                  Power Requirement: +5 (±0.25) VDC, 500 mA                  Size: 100 mm high x 160 mm deep x 30.5 mm wide                  Mounting: VME end panel and back plane. Transmitter does <i>not</i> use electrical bus format, only its physical shape and power supply.</p> <p><b>Note:</b> Electronic temperature accuracy in a given temperature range is the sum of temperature accuracies of input and output. Sensor calibration errors are not included.</p>
---

**1.2 SINGLE ENCLOSURE CASE DESCRIPTION**

Holds one Model 231. Typical dimensions appear below.

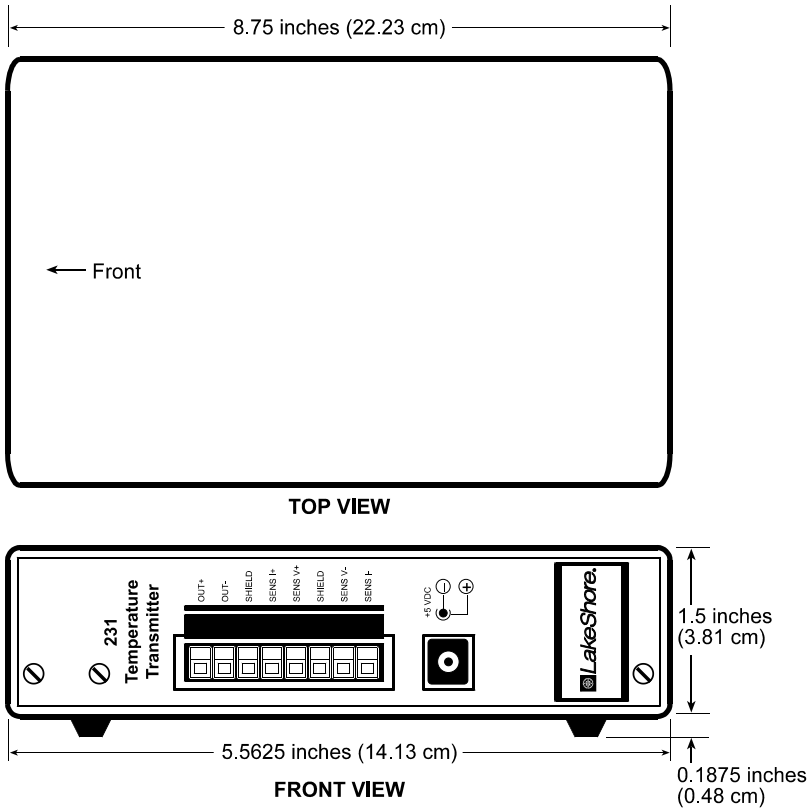

**Figure 1-2. Typical Single Enclosure Case Physical Dimensions**

### 1.3 MULTIPLE UNIT ENCLOSURE CASE DESCRIPTION

The Model 2308-12 VMEbus Rackmount Case holds up to 12 Model 231 units. A +5 VDC power supply with universal input is provided with the case. Specifications and typical dimensions of the case are shown below. Refer to Paragraph 2.5 for further information on the built-in power supply.

**CAUTION:** The Model 2308-12 bus is designed only to power multiple Model 231s. Do *not* use with standard VME cards.

**Table 1-4. Model 2308-12 VMEbus Rackmount Case Specifications**

**No. of Card Slots:** 12

**Size:** 45 × 17.8 × 26 centimeters (17.7 × 7 × 10.25 inches)

**Weight:** 5.5 kilograms (12 pounds)

**Output Voltage:** +5 VDC, 100 mV Peak-to-Peak Ripple

**Output Current:** 6 Amperes (Maximum)

**Input Power:** Universal 85–265 VAC, 47–440 Hz., 60 Watts

**Ambient Temp. Range:** 15–35 °C (59–95 °F)

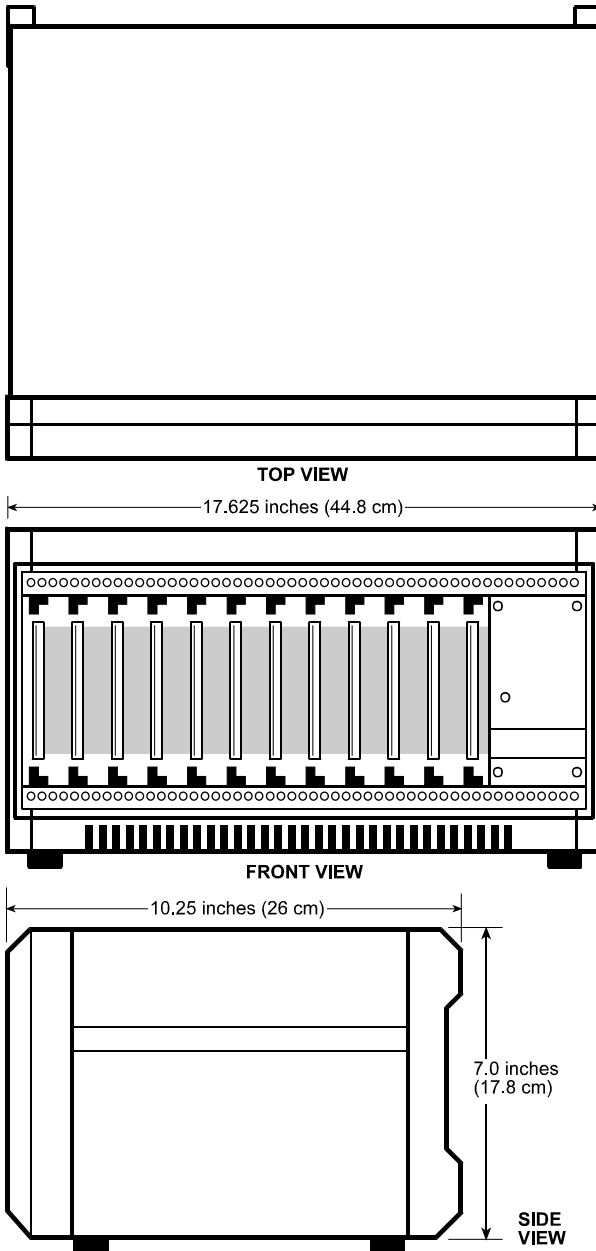

Figure 1-3. Typical Multiple Unit Case Physical Dimensions



## CHAPTER 2

# INSTALLATION

### 2.0 GENERAL

This chapter covers inspection and unpacking in Paragraph 2.1, repackaging for shipment in Paragraph 2.2, sensor installation recommendations in Paragraph 2.3, sensor curve definitions in Paragraph 2.4, and power connections in Paragraph 2.5.

### 2.1 INSPECTION AND UNPACKING

Inspect shipping containers for external damage. Make all claims for damage (apparent or concealed) or partial loss of shipment in writing to Lake Shore within 5 days from receipt of goods. If damage or loss is apparent, please notify the shipping agent immediately.

Open the shipping containers. Use the packing list included with the system to verify receipt of the instrument, sensor, accessories, and manual. Inspect for damage. Inventory all components supplied before discarding any shipping materials. If there is freight damage to the instrument, file proper claims promptly with the carrier and insurance company and notify Lake Shore. Notify Lake Shore immediately of any missing parts. Lake Shore cannot be responsible for any missing parts unless notified within 60 days of shipment. Refer to the standard Lake Shore Warranty on the A Page (immediately behind the title page).

### 2.2 REPACKAGING FOR SHIPMENT

To return the Model 231 or accessories for repair or replacement, obtain a Return Goods Authorization (RGA) number from Technical Service in the United States, or from the authorized sales/service representative from which the product was purchased. Instruments may not be accepted without a RGA number. When returning an instrument for service, Lake Shore must have the following information before attempting any repair.

1. Instrument model and serial number.
2. User name, company, address, and phone number.
3. Malfunction symptoms.
4. Description of system.
5. Returned Goods Authorization (RGA) number.

Repack the system in its original container (if available). Affix shipping labels and FRAGILE warnings. Write RGA number on the outside of the container or on the packing slip. If not available, consult Lake Shore for shipping and packing instructions.

## 2.3 SENSOR INSTALLATION RECOMMENDATIONS

Refer to the Lake Shore Product Catalog for installation details and sensor specifications. Call Lake Shore for copies of application notes or sensor installation questions. Below are general recommendations on sensor installation:

1. Do not ground the sensor.
2. Shield leads and connect shield wire to SHIELD on screw terminal connector only. Do not connect shield at other end of cable.
3. Keep leads as short as possible.
4. Use twisted-pair wire. Use Lake Shore Duo-Twist™ wire (or equivalent) for two-wire, or Quad-Twist™ wire (or equivalent) for four-wire applications.
5. Thermally anchor lead wires.

### 2.3.1 Two-Lead versus Four-Lead Measurements

In two-lead measurement, the leads that measure sensor voltage also carry the current. The voltage measured at the instrument is the sum of the temperature sensor voltage and the IR voltage drop within the two current leads. Since heat flow down the leads can be critical in a cryogenic environment, wire of small diameter and significant resistance per foot is preferred to minimize this heat flow. Consequently, a voltage drop within the leads may exist.

Four-lead measurement confines current to one pair of leads and measures sensor voltage with the other lead pair carrying no current.

#### 2.3.1.1 Two-Lead Measurement

Sometimes system constraints dictate two-lead measurement. Connect the positive terminals (V+ and I+) together and the negative terminals (V- and I-) together at the instrument, then run two leads to the sensor.

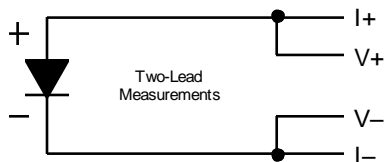

Expect some loss in accuracy; the voltage measured at the voltmeter equals the sum of the sensor voltage and the voltage drop across the connecting leads. The exact measurement error depends on sensor sensitivity and variations resulting from changing temperature. For example, a 10  $\Omega$  lead resistance results in a 0.1 mV voltage error. The resultant temperature error at liquid helium temperature is only 3 mK, but, because of the lower sensitivity (dV/dT) of the diode at higher temperatures, it becomes 10 mK at liquid nitrogen temperature.

### 2.3.1.2 Four-Lead Measurement

All sensors, both two-lead and four-lead devices, can be measured in a four-lead configuration to eliminate the effects of lead resistance. The exact point at which the connecting leads solder to the two-lead sensor normally results in a negligible temperature uncertainty.

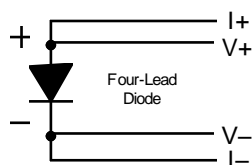

Always use four-lead measurement configuration when a Series PT-100 Platinum Sensor is attached to the Model 231P.

### 2.3.2 Connecting Leads To The Sensor

Excessive heat flow through connecting leads to any temperature sensor may differ the temperature between the active sensing element and the sample to which the sensor mounts. This reflects as a real temperature offset between what is measured and the true sample temperature. Eliminate such temperature errors with proper selection and installation of connecting leads.

To minimize heat flow through the leads, select leads of small diameter and low thermal conductivity. Phosphor-bronze or Manganin wire is commonly used in sizes 32 or 36 AWG. These wires have a fairly low thermal conductivity, yet electrical resistance is not large enough to create measurement problems.

Thermally anchor lead wires at several temperatures between room temperature and cryogenic temperatures to guarantee no heat conduction through the leads to the sensor.

### 2.3.3 Sensor Mounting

Before installing a diode sensor, identify which lead is the anode and which is the cathode. When viewed with the base down and the leads towards the observer, the anode is on the right and the cathode is on the left. The Lake Shore DT-470-SD silicon diode sensor lead configuration is shown to the right. For other sensors, read accompanying literature or consult the manufacturer to positively identify sensor leads. Lead identification should remain clear even after sensor installation. Record the sensor serial number and location.

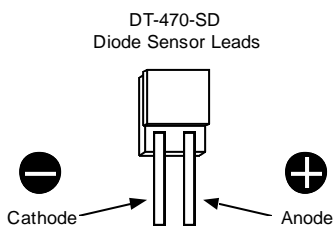

On the DT-470-SD, the base is the largest flat surface. It is sapphire with gold metalization over a nickel buffer layer. The base is electrically isolated from the sensing element and leads; make all thermal contact to the

sensor through the base. A thin braze joint around the sides of the SD package electrically connect to the sensing element. Avoid contact to the sides with any electrically conductive material.

When installing the sensor, make sure there are no electrical shorts or current leakage paths between the leads or between the leads and ground. If IMI-7031 varnish or epoxy is used, it may soften varnish-type lead insulations so that high resistance shunts appear between wires if *sufficient time for curing is not allowed*.

Slide Teflon® spaghetti tubing over bare leads when the possibility of shorting exists. Avoid putting stress on the device leads and allow for thermal contractions that occur during cooling which could fracture a solder joint or lead if installed under tension at room temperature.

For temporary mounting in cold temperature applications, apply a thin layer of Apiezon® N Grease between the sensor and sample to enhance thermal contact under slight pressure. The preferred method for mounting the DT-470-SD sensor is the Lake Shore CO Adapter.

**CAUTION:** Lake Shore will not warranty replace any device damaged by user-designed clamps or solder mounting.

For semi-permanent mountings, use Stycast epoxy instead of Apiezon® N Grease. **NOTE:** Do not apply Stycast epoxy over the DT-470-SD package — sensor stress may shift the readings. In all cases, periodically inspect the sensor mounting to verify good thermal contact to the mounting surface is maintained.

For the Model 231P, Series PT-100 Platinum Sensors follow the same basic procedures for diode type sensors. However, Platinum sensors have no lead polarity, and some of the materials used at cold temperatures will not tolerate the high-temperature range of the Platinum sensor.

### 2.3.4 Measurement Errors Due To AC Noise

Poorly shielded leads or improperly grounded measurement systems can introduce AC noise into the sensor leads. In diode sensors, the AC noise shifts the DC voltage measurement due to the diode non-linear current/voltage characteristics. When this occurs, measured DC voltage is too low and the corresponding temperature reading is high. The measurement error can approach several tenths of a kelvin. To determine if this problem exists, perform either procedure below.

1. Place a capacitor across the diode to shunt induced AC currents. Capacitor size depends on the noise frequency. If noise is related to power line frequency, use a 10  $\mu\text{F}$  capacitor. If AC-coupled digital noise is suspected (digital circuits or interfaces), use a 0.1 to 1  $\mu\text{F}$  capacitor. In either case, if measured DC voltage increases, there is induced noise in the measurement system.

2. Measure AC voltage across the diode with an AC voltmeter or oscilloscope. Most voltmeters do not have the frequency response to measure noise associated with digital circuits or interfaces (which operate in the MHz range). For a thorough discussion of this potential problem, and the magnitude of error which may result, request the paper "Measurement System-Induced Errors In Diode Thermometry," J.K. Krause and B.C. Dodrill, Rev. Sci. Instr. 57 (4), 661, April, 1986 from Lake Shore.

To greatly reduce potential AC noise, connect twisted leads (pairs) between the measurement instruments and the diode sensors. Use 32 or 36 AWG Lake Shore Duo-Twist Cryogenic Wire, which features phosphor bronze wire twisted at 3.15 twists per centimeter (8 twists per inch). Refer to the Lake Shore Product Catalog or contact Lake Shore for further information.

## 2.4 SENSOR CURVE DEFINITION

Model 231 sensor curves include Curve 10, DT-670, Platinum Curve (DIN 43760), and a factory installed CalCurve for a calibrated sensor. After selecting the proper curve, refer to Paragraph 3.1 to set the Model 231 DIP switch.

**Curve 10:** Lake Shore DT-470 Series silicon diodes follow the same standard temperature response Curve 10, which makes them interchangeable. Lake Shore programs Curve 10 into its Temperature Controllers, Digital Thermometers, and Temperature Transmitters.

DT-470 Series silicon diode sensors come in five bands of tracking accuracy, allowing selection based on both performance and expense.

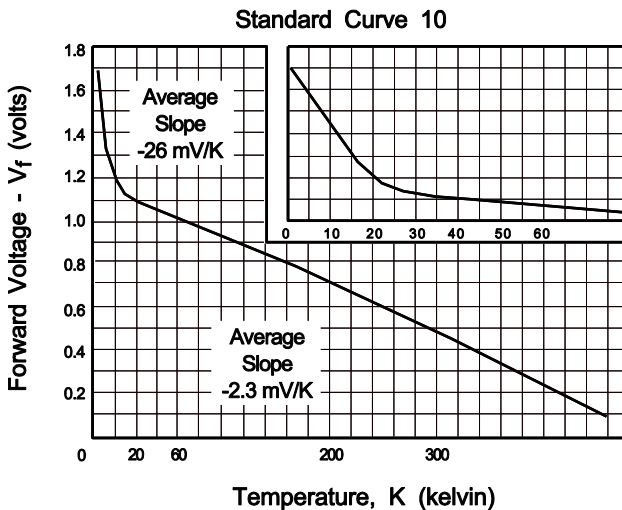

**DT-670:** DT-670 Series Silicon Diode Sensors come in five bands of tracking accuracy, allowing selection based on both performance and price.

**Platinum Curve:** Users of the Model 231P have the option of the standard platinum curve, or the CalCurve. The standard platinum curve detailed in Appendix B conforms to DIN 43760:1980; IEC 751:1983; and 1904:1984.

**CalCurve:** CalCurve is the easiest way to combine the additional performance of a Lake Shore calibrated sensor with the Model 231. The CalCurve is a read-only memory chip (PROM) with specific sensor calibration stored on it. The CalCurve improves combined sensor/instrument accuracy to within  $\pm 0.25K$  or better over the calibrated temperature range of the sensor.

The 8001-231 CalCurve is factory-installed upon order of an instrument with a calibrated sensor. To order an instrument to be used with a currently owned Lake Shore calibrated sensor, Lake Shore requires the sensor model number and serial number at the time of order. The Model 8002-231 is for field installations of the CalCurve in an existing Model 231.

The CalCurve is required with a Lake Shore TG-120 Series Gallium-Aluminum-Arsenide Diode Temperature Sensor.

## 2.5 POWER CONNECTIONS

The Model 231 is powered by the +5 VDC supply in the VME rack or an external power supply. The voltage must be regulated to within  $\pm 0.25$  VDC. Each Model 231 draws up to 500 mA from the supply. The external power supply connector must be S-760 or S-765 Switchcraft (or equivalent) plug (0.218 inch O.D., accepts 0.08 inch diameter pin) with the +5 VDC on the sleeve and return on the center pin.

A wall plug-in power supply Model 2007-XX +5 VDC Regulated Power Supply can be used with the Model 231. Power Supply input is based on local power requirements as follows:

MODEL	INPUT POWER
2007-12	120 V 60 Hz. power source
2007-22	230 V 50 Hz. power source

**CAUTION:** Never ground both the sensor and the 4–20 mA output. Ground the sensor, or the output, but not both.

The Model 2308-10 VMEbus rackmount case has a built-in power supply for up to twelve Model 231s. The built-in power supply has a universal input: 85 to 265 VAC, 47 to 440 Hz, 60 watts.

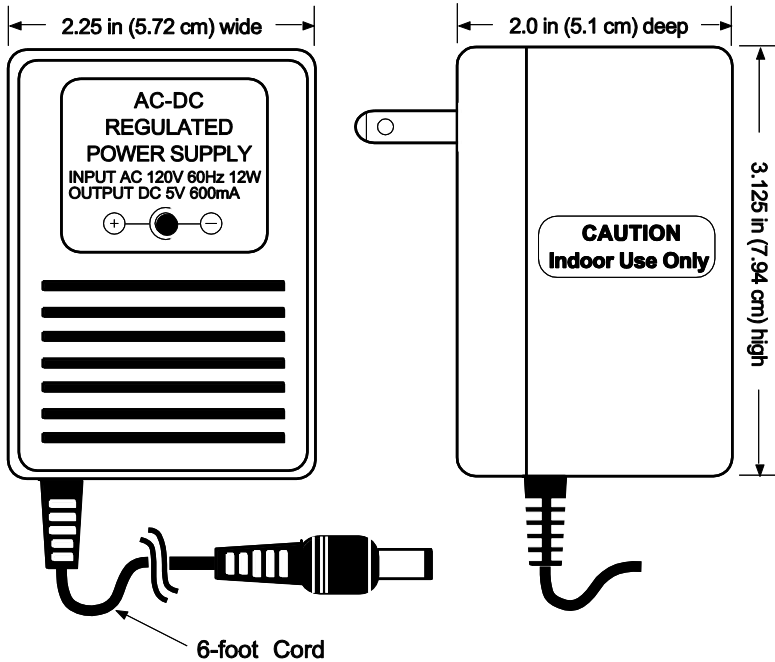

C-231-2-1.eps

Figure 2-1. Typical Wall Plug-In Power Supply

This Page Intentionally Left Blank



# CHAPTER 3

## OPERATION

### 3.0 GENERAL

This chapter covers Printed Circuit Board (PCB) DIP Switch Settings in Paragraph 3.1 and Output Current and Voltage-to-Temperature Conversion in Paragraph 3.2.

### 3.1 PCB DIP SWITCH SETTINGS

Before placing the unit into service, the Model 231 DIP switch (S1) must be properly configured. Once an operating range is selected, the corresponding range number should be enabled on the Model 231 PCB DIP Switch (S1). See Figure 3-1. Select only one range at a time. The range is enabled when the switch is closed (ON). Units ship from the factory with the DIP switch set to RANGE4 closed (ON). Units ship from the factory with the DIP switch set to RANGE4 closed (0 to 325 K).

For the Model **231**, set the CURVE switch to **open** for the DT470 Curve 10 or the CalCurve option (if present) or **closed** for the DT-670 Curve. For the Model **231P**, set the CURVE switch to **open** for the platinum curve or **closed** for the CalCurve option. Unless CalCurve is specified, units ship from the factory with the DIP switch set to CURVE **open**.

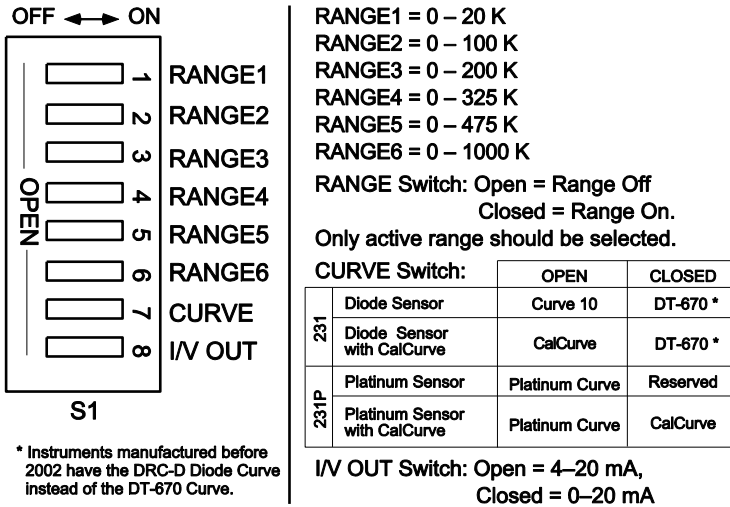

C-231-3-1.eps

**Figure 3-1. Model 231 DIP Switch (S1) Settings**

Current/Voltage (I/V) OUT is for selection of proper output type. Open is for 4–20 mA and closed is for 0–20 mA. The 4–20 mA is an industry standard, while the 0–20 mA is provided to translate output into voltage scaled up to 10 V. For a 0–10 V output, use the supplied 500 Ω ±0.02% precision resistor as a load across the OUT+ and OUT– terminals. Load resistors less than 500 Ω can be used to convert output to voltage using the following formula:

Unless otherwise specified, units ship from the factory with the I/V OUT DIP switch set to open.

### 3.2 OUTPUT TO TEMPERATURE CONVERSION

The output current or voltage is directly proportional to the temperature reading. For the 4–20 mA output, the following formula converts output current to temperature:

$T = A + B \times I_{OUT}$ , where T = temperature in kelvin,  $I_{OUT}$  = output current in mA, and A and B are constants (from Table 3-1) depending on temperature.

For the 0–20 mA output (using the included 500 Ω resistor for 0–10 V), the following formula converts output voltage to temperature:

$T = C \times V_{OUT}$ , where T = temperature in kelvin,  $V_{OUT}$  = output voltage, and C is a constant (from Table 3-1) depending on temperature.

**Table 3-1. Conversion Parameters for Temperature in K**

RANGE	TEMP. (K)	4–20 mA		0–10 V
		A (K)	B (K/mA)	C (K/V)
RANGE1	0 – 20	–5.00	1.2500	2.0
RANGE2	0 – 100	–25.00	6.2500	10.0
RANGE3	0 – 200	–50.00	12.5000	20.0
RANGE4	0 – 325	–81.25	20.3125	32.5
RANGE5	0 – 475	–118.75	29.6875	47.5
RANGE6	0 – 1000	–250.00	62.5000	100.0

## CHAPTER 4

# SERVICE

### 4.0 GENERAL

This chapter cover general troubleshooting in Paragraph 4.1, Model 231 connectors in Paragraph 4.2, and calibration in Paragraph 4.3.

### 4.1 GENERAL TROUBLESHOOTING

#### 4.1.1 No Output (On-Board LED Off)

Check that external power supply output is +5 VDC. If not, replace supply. If using the front panel input jack (J2), make certain center post of connector coming from power supply is NEGATIVE. If not, correct wiring. If using front panel input jack (J2), verify external power supply is regulated at +5 VDC and can supply a minimum of 500 mA. Also verify that OUT+ and SHIELD are *not* connected to each other.

Due to extensive protection circuitry installed in Model 231, all the above problems eventually cause the 0.5 A slow blow fuse to burn out. After correction, replace the blown fuse with identical size and type.

#### 4.1.2 Output Stops Before Reaching Upper Limit

Normally caused by too high resistance of output monitoring device. Absolute maximum acceptable resistance is 500  $\Omega$ . Also verify that proper range DIP switch is selected.

#### 4.1.3 Output Is Incorrect Value (Small Error)

Can be caused by incorrect curve selection for the sensor type. See Figure 3-1. Another cause for a small error is the output resistor for output current to voltage conversion is not high precision. When using voltage out, the output resistor must be  $\pm 0.02\%$  accurate (or better) and have low drift.

#### 4.1.4 Output Is Incorrect Value (Large Error)

Can be caused by incorrect sensor wiring. To test wiring, place voltmeter between SENS V+ and SENS V- connection. With sensor connected, power up the Model 231. With the sensor at room temperature, the voltmeter should read about 0.5 VDC for a diode sensor, or about 55 mV for a platinum sensor. If voltage is higher than 5 VDC, then sensor connections may be open. If sensor voltage polarity is negative, SENS V+ and SENS V- leads are reversed. With the sensor at operating temperature, the voltage readings should correspond to Curve 10 for diode sensors, or DIN 43760 for platinum sensors, as detailed in Appendix A.

#### 4.2 MODEL 231 CONNECTORS

There are three connectors on the Model 231. The two front panel connectors are the 8 pin terminal block (J3) and the power connector (J2). See Figure 4-1. The rear connector (J1) is for connecting to the VMEbus. See Figure 4-2.

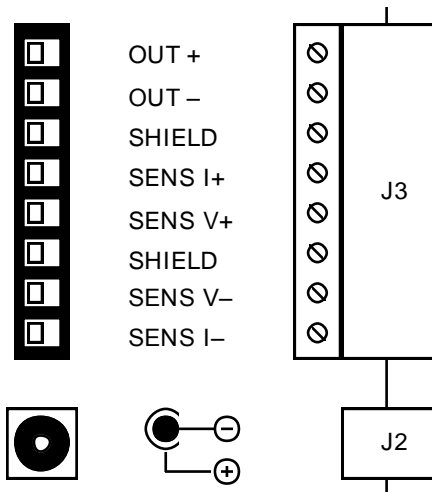
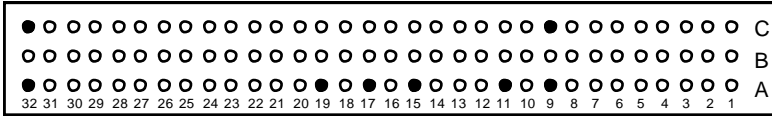

Figure 4-1. Front Panel Connectors J2 and J3 Details

J1 – VMEbus Connector – End View



● = Pin Used

○ = Pin Not Used (Entire Row B is not present)

PIN NO.	ROW A	ROW B	ROW C
1-8	Not Used	Entire Row Not Present	Not Used
9	GND		GND
10	Not Used		Not Used
11	GND		Not Used
12-14	Not Used		Not Used
15	GND		Not Used
16	Not Used		Not Used
17	GND		Not Used
18	Not Used		Not Used
19	GND		Not Used
20-31	Not Used		Not Used
32	+5 VDC		+5 VDC

Figure 4-2. VMEbus Connector J1 Details

### 4.3 CALIBRATION

This section covers various aspects of Model 231 calibration: Required Test Equipment (Paragraph 4.3.1), Reference Calibration (Paragraph 4.3.2), and Calibration (Paragraph 4.3.3). See Figure 4-3 for the Model 231 PCB layout. Allow 5 minutes warm-up before calibration.

#### 4.3.1 Required Test Equipment

1. A digital voltmeter (DVM) that measures DC voltage between 0 and 10 V accurately to 0.0001 V.
2. A regulated +5 V DC power supply with tolerance within  $\pm 0.25$  V, capable to source 500 mA on an S-760 or S-765 Switchcraft (or equivalent) power plug (0.218 inch outside diameter, accepts 0.08 inch diameter pin). +5 V is on sleeve with center pin return.
3. Mating screw terminal to Model 231 front panel signal connector.
4. A 500  $\Omega$ , 0.02% (or better) precision resistor.
5. Three jumper wires.

### 4.3.2 Reference Calibration

Perform this reference calibration before output calibration.

1. Connect DVM negative lead to Model 231 reference ground (REF GND) on TP2, and positive lead to VREF on TP3.
2. Adjust trimpot R33, VREF TRIM, until DVM reads 2.5000 V  $\pm$ 0.0001 V.

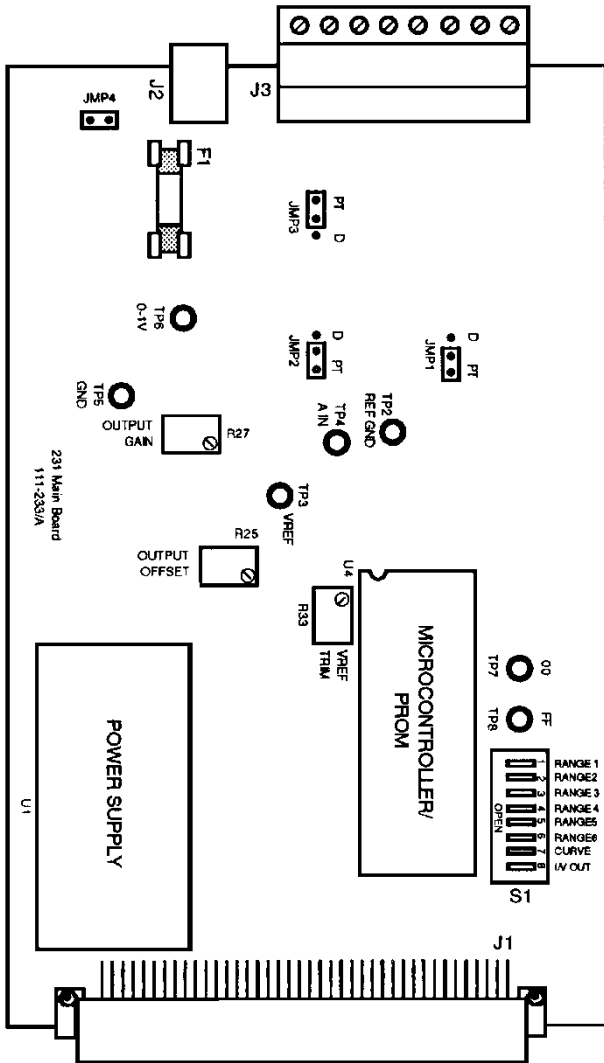

P-231-4-3.bmp

Figure 4-3. Model 231 PCB Layout

### 4.3.3 Output Calibration

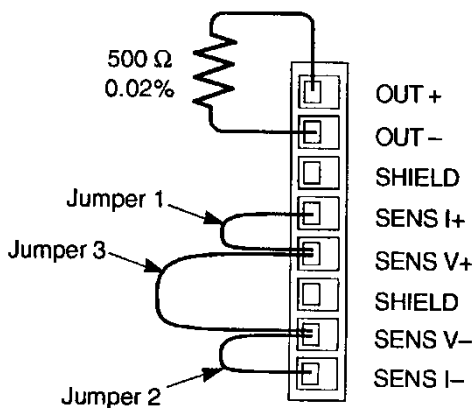

1. Connect 500 Ω, 0.02% resistor to Model 231 pins OUT+ and OUT-.
2. Use jumper wires 1 and 2 to short V+ to I+ and V- to I-.
3. Record configuration of DIP Switch (S1) positions 1 thru 6.
4. Place DIP Switch (S1) positions 1 through 6 to open.
5. Place DVM across 500 Ω resistor. Reading should be about 10 V.
6. Use jumper wire 3 to short V+ to V-. (Leave Jumpers 1 and 2 in place.)
7. DVM reading should drop to about 0 V. Allow 10 seconds for reading to stabilize.
8. Adjust trimpot R25, OUTPUT OFFSET, until DVM reading is between 0 and 0.0001 V.
9. Remove jumper wire 3 between V+ and V-. (Leave Jumpers 1 and 2 in place.)
10. DVM reading should be about 10 V.
11. Adjust trimpot R27, OUTPUT GAIN, until DVM reading is 10.0000 ±0.0001 V.
12. Re-check offset calibration (Step 8) and adjust as needed. Re-check gain calibration (Step 11) and adjust as needed.
13. Remove all jumpers.
14. Return configuration of DIP Switch (S1) positions 1 thru 6 to that recorded in Step 3.
15. Calibration is complete.

This Page Intentionally Left Blank



## CHAPTER 5

# OPTIONS AND ACCESSORIES

### 5.0 GENERAL

This chapter lists Model 231 enclosures, options, accessories, sensors, wires, and special equipment.

### 5.1 ENCLOSURES

<i>Model</i>	<i>Description Of Enclosure</i>
2308-1	Benchtop Enclosure for one Model 231 PCB.
2308-12	VMEbus rack mount case with built-in power supply for up to 12 Model 231s.

### 5.2 OPTIONS

<i>Model</i>	<i>Description Of Option</i>
8001-231	Factory Installed CalCurve. Allows instrument to more accurately use the calibration data to calculate and output current proportional to temperature. Requires a calibrated sensor.
8002-231	Field Installed CalCurve. Requires field installation of a new microprocessor/memory IC. Allows instrument to more accurately use the calibration data to calculate and output current proportional to temperature. Requires a calibrated sensor.

### 5.3 ACCESSORIES

<i>Model</i>	<i>Description Of Accessory</i>
MAN-231	Model 231 User's Manual
106-739	Input Terminal Mating Connector
2007-12	Wall Plug-in Power Supply, 120 V 60 Hz power source
2007-22	Wall Plug-in Power Supply, 230 V 50 Hz power source
103-626	Resistor, Precision, 500 $\Omega$ , $\pm 0.02\%$

### 5.4 WIRES

<i>P/N</i>	<i>Description Of Cable</i>
9001-005	<b>Quad-Twist™ Cryogenic Wire.</b> Two twisted pairs, phosphor-bronze wire, 36 AWG, 0.127 mm (0.005 inch) diameter.
9001-006	<b>Duo-Twist™ Cryogenic Wire.</b> Single twisted pair, phosphor-bronze wire, 36 AWG, 0.127 mm (0.005 inch) diameter.
9001-007	<b>Quad-Lead™ Cryogenic Wire.</b> Phosphor-bronze wire, flat, 32 AWG, 0.203 mm (0.008 inch) diameter.
9001-008	<b>Quad-Lead™ Cryogenic Wire.</b> Phosphor-bronze wire, flat, 36 AWG, 0.127 mm (0.005 inch) diameter.
—	Any quality dual shield twisted pair wire for dewar to Model 231 connector.

## 5.5 SENSORS

<b>Sensor No.</b>	<b>Description Of Sensor</b>
Series DT-414	Unencapsulated Silicon Diode mounted on a flat substrate. This chip-level sensor offers minimal thermal mass and minimal physical size. Die attachment is with silver epoxy. The exposed gold wires are fragile. Uses the same silicon chip used in the DT-470 Series.
Series DT-420	Miniature Silicon Diode Temperature Sensor. Same silicon chip used in the DT-470. Configured for installation on flat surfaces.
Series DT-470	Silicon Diode Temperature Sensor. Interchangeable, repeatable, accurate, wide range customized for cryogenics.
Series DT-471	An economical version of the DT-470 for applications where temperature measurements below 10 K are not required.
Series DT-670	Lake Shore's newest silicon diode temperature sensor. Interchangeable, repeatable, accurate, wide range customized for cryogenics.
Series TG-120	A wide range Gallium-Aluminum-Arsenide (GaAlAs) Diode Sensor well suited for temperature measurement in low to moderate magnetic fields.
Series PT-100	Platinum Resistance Thermometer is an excellent choice for cryogenic temperature sensing and control in the range from 30 K to 873 K (-243 °C to 600 °C).

This Page Intentionally Left Blank

## APPENDIX A

### MODEL 231 CURVE TABLES

Table A-1. Lake Shore Standard Diode Curves

Break-point No.	DT-670 Curve		Curve 10	
	Temp.(K)	Voltage	Temp.(K)	Voltage
1	499.9	0.00000	499.9	0.00000
2	475.0	0.14703	475.0	0.09032
3	445.0	0.21870	460.0	0.12536
4	400.0	0.32600	435.0	0.18696
5	330.0	0.49026	390.0	0.29958
6	285.0	0.59422	340.0	0.42238
7	250.0	0.67357	280.0	0.56707
8	215.0	0.75123	230.0	0.68580
9	185.0	0.81604	195.0	0.76717
10	160.0	0.86861	165.0	0.83541
11	140.0	0.90948	140.0	0.89082
12	120.0	0.94910	115.0	0.94455
13	100.0	0.98709	95.0	0.98574
14	85.0	1.01423	77.4	1.02044
15	70.0	1.04026	60.0	1.05277
16	52.0	1.06998	44.0	1.08105
17	36.0	1.09543	36.0	1.09477
18	30.0	1.10612	31.0	1.10465
19	27.0	1.11272	28.0	1.11202
20	26.0	1.11566	27.0	1.11517
21	25.0	1.11945	26.0	1.11896
22	24.0	1.12592	25.0	1.12463
23	23.0	1.14082	24.0	1.13598
24	21.0	1.18219	20.0	1.21555
25	15.0	1.27532	15.5	1.29340
26	12.0	1.33400	12.0	1.36687
27	9.0	1.41020	9.0	1.44850
28	3.8	1.59237	3.8	1.64112
29	1.9	1.63785	2.0	1.68912
30	1.4	1.64411	1.4	1.69808
31	0.0	6.55360	0.0	6.55360

**Table A-2. Series PT-100 Platinum Resistance Curve**

Temperature in kelvin (K), resistance in ohms ( $\Omega$ ), and slope in ohms per kelvin ( $\Omega/K$ ). Temperature coefficient (237.15–373.15): 0.00385  $\Omega/\Omega/K$ . Conforms to DIN 43760:1980; IEC 751:1983; and BS 1904:1984.

T (K)	R ( $\Omega$ ) *	dR/dT ( $\Omega/K$ )	Class B	
			$\pm K$	$\pm\Omega$
14.0	1.797	+0.035		
20.0	2.147	+0.084		
30.0	3.508	+0.190		
40.0	5.938	+0.291		
50.0	9.228	+0.361		
70.0	17.128	+0.414	1.32	0.55
100.0	29.987	+0.411	1.17	0.48
150.0	50.815	+0.405	0.92	0.37
200.0	71.073	+0.399	0.67	0.27
300.0	110.452	+0.388	0.43	0.17
400.0	148.616	+0.376	0.93	0.35
500.0	185.035	+0.364	1.43	0.52
600.0	221.535	+0.353	1.93	0.68
700.0	256.243	+0.341	2.43	0.83
800.0	289.789	+0.330	2.93	0.97
900.0	322.176	+0.318	3.43	1.09
1000.0	353.402	+0.306	3.93	1.20

\* R (0 °C) = 100 Standard 751 IEC 1983 from 70 K to 1000 K.

## APPENDIX B

### GLOSSARY OF TERMINOLOGY

**absolute zero.** The temperature of  $-273.15\text{ }^{\circ}\text{C}$ , or  $-459.67\text{ }^{\circ}\text{F}$ , or  $0\text{ K}$ , thought to be the temperature at which molecular motion vanishes and a body would have no heat energy.<sup>1</sup>

**accuracy.** The degree of correctness with which a measured value agrees with the true value.<sup>2</sup>

**electronic accuracy.** The accuracy of an instrument independent of the sensor.

**sensor accuracy.** The accuracy of a temperature sensor and its associated calibration or its ability to match a standard curve.

**ambient temperature.** The temperature of the surrounding medium, such as gas or liquid, which comes into contact with the apparatus.<sup>1</sup>

**anode.** The terminal that is positive with respect to the other terminal when the diode is biased in the forward direction.<sup>2</sup>



**asphyxiant gas.** A gas which has little or no positive toxic effect but which can bring about unconsciousness and death by displacing air and thus depriving an organism of oxygen.

**calibration.** To determine, by measurement or comparison with a standard, the correct (accurate) value of each scale reading on a meter or other device, or the correct value for each setting of a control knob.<sup>1</sup>

**cathode.** The terminal from which forward current flows to the external circuit.<sup>2</sup>



**Celsius ( $^{\circ}\text{C}$ ) Scale.** A temperature scale that registers the freezing point of water as  $0\text{ }^{\circ}\text{C}$  and the boiling point as  $100\text{ }^{\circ}\text{C}$  under normal atmospheric pressure. Celsius degrees are purely derived units, calculated from the Kelvin Thermodynamic Scale. Formerly known as "centigrade." See Temperature for conversions.

**cgs system of units.** A system in which the basic units are the centimeter, gram, and second.<sup>2</sup>

**cryogen.** See cryogenic fluid.<sup>1</sup>

**cryogenic.** Refers to the field of low temperatures, usually  $-130\text{ }^{\circ}\text{F}$  or below, as defined by 173.300(f) of Title 49 of the Code of Federal Regulations.

**cryogenic fluid.** A liquid that boils at temperatures of less than about  $110\text{ K}$  at atmospheric pressure, such as hydrogen, helium, nitrogen, oxygen, air, or methane. Also known as cryogen.<sup>1</sup>

**cryostat.** An apparatus used to provide low-temperature environments in which operations may be carried out under controlled conditions.<sup>1</sup>

**curve.** A set of data that defines the temperature response of a temperature sensor. It is used to convert the sensor signal to temperature.

**Curve 10.** The voltage versus temperature characteristic followed by all DT-400 Series Silicon Diode Temperature Sensors.

**degree.** An incremental value in the temperature scale, i.e., there are 100 degrees between the ice point and the boiling point of water in the Celsius scale and 180 degrees between the same two points in the Fahrenheit scale.

**drift, instrument.** An undesired but relatively slow change in output over a period of time, with a fixed reference input. *Note:* Drift is usually expressed in percent of the maximum rated value of the variable being measured.<sup>2</sup>

**electrostatic discharge (ESD).** A transfer of electrostatic charge between bodies at different electrostatic potentials caused by direct contact or induced by an electrostatic field.

**error.** Any discrepancy between a computed, observed, or measured quantity and the true, specified, or theoretically correct value or condition.<sup>2</sup>

**excitation.** Either an AC or DC input to a sensor used to produce an output signal. Common excitations include: constant current, constant voltage, or constant power.

**Fahrenheit (°F) Scale.** A temperature scale that registers the freezing point of water as 32 °F and the boiling point as 212 °F under normal atmospheric pressure. See Temperature for conversions.

**four-lead.** measurement technique where one pair of excitation leads and an independent pair of measurement leads are used to measure a sensor. This method reduces the effect of lead resistance on the measurement.

**GaAlAs.** Gallium-aluminum-arsenide semiconducting material used to make the special Lake Shore TG family of diode temperature sensors.

**gaussian system (units).** A system in which centimeter-gram-second units are used for electric and magnetic quantities.

**ground.** A conducting connection, whether intentional or accidental, by which an electric circuit or equipment is connected to the earth, or to some conducting body of relatively large extent that serves in place of the earth. *Note:* It is used for establishing and maintaining the potential of the earth (or of the conducting body) or approximately that potential, on conductors connected to it, and for conducting ground current to and from the earth (or of the conducting body).<sup>2</sup>

**hazard communication standard (HCS).** The OSHA standard cited in 29 CFR 1910.1200 requiring communication of risks from hazardous substances to workers in regulated facilities.

**hertz (Hz).** A unit of frequency equal to one cycle per second.

**international system of units (SI).** A universal coherent system of units in which the following seven units are considered basic: meter, kilogram, second, ampere, kelvin, mole, and candela. The International System of Units, or *Système International d'Unités* (SI), was promulgated in 1960 by the Eleventh General Conference on Weights and Measures. For definition, spelling, and protocols, see Reference 3 for a short, convenient guide.

**interpolation table.** A table listing the output and sensitivity of a sensor at regular or defined points which may be different from the points at which calibration data was taken.

**IPTS-68.** International Practical Temperature Scale of 1968. Also abbreviated as  $T_{68}$ .

**isolated (neutral system).** A system that has no intentional connection to ground except through indicating, measuring, or protective devices of very-high impedance.<sup>2</sup>

**ITS-90.** International Temperature Scale of 1990. Also abbreviated as  $T_{90}$ . This scale was designed to bring into as close a coincidence with thermodynamic temperatures as the best estimates in 1989 allowed.

**Kelvin (K).** The unit of temperature on the Kelvin Scale. It is one of the base units of SI. The word "degree" and its symbol (°) are omitted from this unit. See Temperature Scale for conversions.



**Kelvin Scale.** The Kelvin Thermodynamic Temperature Scale is the basis for all international scales, including the ITS-90. It is fixed at two points: the absolute zero of temperature (0 K), and the triple point of water (273.16 K), the equilibrium temperature that pure water reaches in the presence of ice and its own vapor.

**liquid helium (LHe).** Used for low temperature and superconductivity research: minimum purity 99.998%. Boiling point at 1 atm = 4.2 K. Latent heat of vaporization = 2.6 kilojoules per liter. Liquid density = 0.125 kilograms per liter.

EPA Hazard Categories: Immediate (Acute) Health and Sudden Release of Pressure Hazards

DOT Label: Nonflammable Gas  
 DOT Class: Nonflammable Gas  
 DOT Name: Helium, Refrigerated Liquid  
 DOT ID No: UN 1963

**liquid nitrogen (LN<sub>2</sub>).** Also used for low temperature and superconductivity research and for its refrigeration properties such as in freezing tissue cultures: minimum purity 99.998%, O<sub>2</sub> 8 ppm max. Boiling point at 1 atm = 77.4 K. Latent heat of vaporization = 160 kilojoules per liter. Liquid density = 0.81 kilograms per liter.

EPA Hazard Categories: Immediate (Acute) Health and Sudden Release of Pressure Hazards

DOT Label: Nonflammable Gas  
 DOT Class: Nonflammable Gas  
 DOT Name: Nitrogen, Refrigerated Liquid  
 DOT ID No: UN 1977

**material safety data sheet (MSDS).** OSHA Form 20 contains descriptive information on hazardous chemicals under the OSHA Hazard Communication Standard (HCS). These data sheets also provide precautionary information on the safe handling of the gas as well as emergency and first aid procedures.

**MKSA System of Units.** A system in which the basic units are the meter, kilogram, and second, and the ampere is a derived unit defined by assigning the magnitude  $4\pi \times 10^{-7}$  to the rationalized magnetic constant (sometimes called the permeability of space).

**NBS.** National Bureau of Standards. Now referred to as NIST.

**National Institute of Standards and Technology (NIST).** Government agency located in Gaithersburg, Maryland and Boulder, Colorado, that defines measurement standards in the United States.

**platinum (Pt).** A common temperature sensing material fabricated from pure platinum to make the Lake Shore PT family of resistance temperature sensor elements.

**prefixes.** SI prefixes used throughout this manual are as follows:

Factor	Prefix	Symbol	Factor	Prefix	Symbol
10 <sup>24</sup>	yotta	Y	10 <sup>-1</sup>	deci	d
10 <sup>21</sup>	zetta	Z	10 <sup>-2</sup>	centi	c
10 <sup>18</sup>	exa	E	10 <sup>-3</sup>	milli	m
10 <sup>15</sup>	peta	P	10 <sup>-6</sup>	micro	μ
10 <sup>12</sup>	tera	T	10 <sup>-9</sup>	nano	n
10 <sup>9</sup>	giga	G	10 <sup>-12</sup>	pico	p
10 <sup>6</sup>	mega	M	10 <sup>-15</sup>	femto	f
10 <sup>3</sup>	kilo	k	10 <sup>-18</sup>	atto	a
10 <sup>2</sup>	hecto	h	10 <sup>-21</sup>	zepto	z
10 <sup>1</sup>	deka	da	10 <sup>-24</sup>	yocto	y

**probe.** A long, thin body containing a sensing element which can be inserted into a system in order to make measurements. Typically, the measurement is localized to the region near the tip of the probe.

**repeatability.** The closeness of agreement among repeated measurements of the same variable under the same conditions.<sup>2</sup>

**self-heating.** Heating of a device due to dissipation of power resulting from the excitation applied to the device. The output signal from a sensor increases with excitation level, but so does the self-heating and the associated temperature measurement error.

**sensitivity.** The ratio of the response or change induced in the output to a stimulus or change in the input. Temperature sensitivity of a resistance temperature detector is expressed as  $S = dR/dT$ .

**setpoint.** The value selected to be maintained by an automatic controller.<sup>1</sup>

**SI.** Système International d'Unités. See International System of Units.

**silicon diode.** Temperature sensor based on the forward voltage drop at constant current through a pn semiconductor junction formed in crystalline silicon.

**stability.** The ability of an instrument or sensor to maintain a constant output given a constant input.

**temperature scales.** See Kelvin Scale, Celsius Scale, and ITS-90. Proper metric usage requires that only kelvin and degrees Celsius be used. However, since degrees Fahrenheit is in such common use, all three scales are delineated as follows:

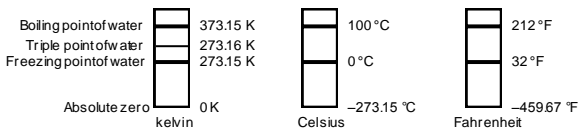

To convert kelvin to Celsius, subtract 273.15.

To convert Celsius to Fahrenheit: multiply °C by 1.8 then add 32, or:  $^{\circ}\text{F} = (1.8 \times ^{\circ}\text{C}) + 32$ .

To convert Fahrenheit to Celsius: subtract 32 from °F then divide by 1.8, or:  $^{\circ}\text{C} = (^{\circ}\text{F} - 32) / 1.8$ .

**tolerance.** The range between allowable maximum and minimum values.

**two-lead.** Measurement technique where one pair of leads is used for both excitation and measurement of a sensor. This method will not reduce the effect of lead resistance on the measurement.

### References:

- 1 Sybil P. Parker, Editor. *Dictionary of Scientific and Technical Terms: Third Edition*. New York: McGraw Hill, 1969 (ISBN 0-395-20360-0)
- 2 Christopher J. Booth, Editor. *The New IEEE Standard Dictionary of Electrical and Electronic Terms: IEEE Std 100-1992, Fifth Edition*. New York: Institute of Electrical and Electronics Engineers, 1993 (ISBN 1-55937-240-0). Definitions printed with permission of the IEEE.
- 3 Nelson, Robert A. *Guide For Metric Practice*, Page BG7-8, Physics Today, Eleventh Annual Buyer's Guide, August 1994 (ISSN 0031-9228 coden PHTOAD)

